

MAXIM

MAX3760 Evaluation Kit

Evaluates: MAX3760

General Description

The MAX3760 evaluation kit (EV kit) simplifies evaluation of the MAX3760 transimpedance preamplifier. The MAX3760 is optimized for hybrid applications that place the preamplifier die in the same package with a photodetector. The EV kit uses a packaged version of the MAX3760 to simplify product evaluation. It allows both optical and electrical testing.

The MAX3760's input voltage is determined by internal circuitry. When the input is connected to a photodiode, the MAX3760's input voltage determines the reverse diode voltage. Electrical signal sources connected to the input must be AC coupled. AC coupling the input removes the signal's DC component. Many of the MAX3760's specifications are affected by the average DC input current, which is normally present when the input signal is derived from a photodiode. A current mirror and simple bias-tee are used to create a signal similar to that of a photodiode.

The MAX3760 EV kit has several mounting holes for inserting common photodiodes, allowing optical testing.

Features

- ◆ **Single +5V Supply**
- ◆ **Differential Output Drives 100Ω Load**
- ◆ **560MHz Bandwidth**
- ◆ **Electrical or Optical Input**
- ◆ **Provision for User-Supplied Photodiode**
- ◆ **Fully Assembled and Tested**

Ordering Information

PART	TEMP. RANGE	BOARD TYPE
MAX3760EVKIT-SO	-40°C to +85°C	Surface Mount

Component Suppliers

SUPPLIER	PHONE	FAX
AVX	803-946-0690	803-626-3123
Central Semiconductor	516-435-1110	516-435-1824
Zetex	516-543-7100	516-864-7630

Component List

DESIGNATION	QTY	DESCRIPTION
C1, C9	2	33μF, 25V tantalum capacitors AVX TAJE336K025R
C2, C3, C8	3	0.01μF, 25V ceramic capacitors
C4, C5, C6	3	0.1μF, 25V ceramic capacitors
R1	1	49.9Ω, 1% resistor
R2, R3	2	200Ω, 5% resistors
R4	1	2kΩ, 5% resistor
R5	1	2kΩ, 1% resistor
R6, R8	2	1kΩ, 1% resistors
R7	1	10kΩ potentiometer
L1	1	47μH inductor Panasonic ELJ-FA470KF2

DESIGNATION	QTY	DESCRIPTION
L2, L3	2	4.7μH inductors Panasonic ELJ-FA4R7KF2
Q1, Q2	2	PNP small-signal transistors Zetex BCX71KCT
D2	1	High-speed switching diode Central Semiconductor CMPD4448
U1	1	MAX3760ESA
J1, J3, J4	3	SMA connectors (PC edge mount) E.F. Johnson 142-0701-801
JU1, JU2	2	2-pin headers
None	2	Shunts on JU1 and JU2
None	1	MAX3760 data sheet

MAX3760 Evaluation Kit

Quick Start

Test Equipment Required

- Signal-source sine-wave generator or network analyzer with range to 650MHz
- Signal-source function generator with range to 1MHz
- Signal-source pattern generator
- Power supply capable of 5.5V, 35mA output with current limit
- Oscilloscope with at least 1GHz bandwidth
- Wideband noise meter or RF power meter
- 470MHz filter with Bessel response (example: Mini Circuits SBLP-467 filter)

Setup

- 1) Connect a 5V power supply to VCC1 and GND.
- 2) Remove the shunts from JU1 and JU2.
- 3) Connect VOUT+ and VOUT- to a dual-channel oscilloscope through terminated 50Ω cables.
- 4) Apply a 150mVp-p, 311MHz square wave to VIN.
- 5) Observe each output of approximately 150mVp-p on the oscilloscope.

Detailed Description

Connections, Adjustments, and Controls

VCC1 Connection

This connection provides supply current for the MAX3760. Connect to 5V.

VCC2 Connection

This connection provides supply current for the current mirror that adds the DC component to the input signal. Connect to 5V if used.

J1-VIN Connection

A signal generator can be connected here. This input is terminated with 50Ω to ground and AC coupled to IN (MAX3760) through series resistors (3000Ω). The AC signal input current to the MAX3760 is $V_{IN}/3000\Omega$.

J3-VOUT+, J4-VOUT- Connection

These are the MAX3760 outputs. These connectors are AC coupled to the MAX3760 and connect directly to test equipment with 50Ω input impedance.

Jumper JU1

This jumper is in series with the current mirror that adds a DC component to the input signal. This is a convenient place to measure the DC input current.

Jumper JU2

This jumper grounds the MAX3760's COMP pin. The DC cancellation circuit is disabled when COMP is grounded.

Potentiometer R7

This potentiometer controls the amount of DC current added to the input signal.

Measurement Information

AC Measurement

When making AC measurements, place a shunt on JU1 after setting the DC signal current. Wires attached to this jumper add noise to the signal.

DC Measurement

For most DC measurements, place a shunt on JU2 to disable the DC cancellation circuit. Measure output off-set with JU2 open.

Noise Measurement

Remove R5 before attempting noise measurements to minimize input capacitance. With R5 removed the total capacitance at the IN pin is 0.75pF.

Photodiode Emulation

Use the following relations to emulate a photodiode input with a signal generator and the current mirror (Figure 1):

P_{AVE} = average power = $(P1 + P0) / 2$ (assuming 50% average duty cycle)

r_e = extinction ratio = $P1 / P0$

$P1$ = high signal level = $2P_{AVE} (r_e) / (r_e + 1)$

$P0$ = low signal level = $2P_{AVE} / (r_e + 1)$

$P1-P0$ = p-p signal amplitude = $2P_{AVE}(r_e - 1) / (r_e + 1)$

Input current is related to optical power by the photodiode responsivity (ρ), as shown in the following equations:

$$I_{AVE} = (P_{AVE})\rho$$

For example, follow these steps to emulate a signal with an average power of -20dBm and an extinction ratio of 10:

- 1) -20dBm optical power will produce 10μA of average input current (assume photodiode responsivity of 1A/W). Install a current meter at JU1. Adjust R7 until current is 10μA.
- 2) The signal amplitude is $2P_{AVE}(r_e - 1) / (r_e + 1) = 16.3\mu A$. To generate this current through the 3000Ω input resistors, set the signal source to produce an output level of $16.3\mu A \times 3000\Omega = 49mVp-p$.

MAX3760 Evaluation Kit

Using a Photodiode

- 1) Remove resistor R5 before installing your photodiode in holes provided at location D1.
- 2) Connect the photodiode anode to IN (pin 2) on the MAX3760.
- 3) Connect the photodiode cathode to the junction of C8 and R8.
- 4) Connect the photodiode case ground to INREF.

Supply Current

Supply current, as specified in the MAX3760 data sheet, is the current flowing into the VCC1 pad. Current flowing into VCC2 pad powers the current mirror only.

Layout Considerations

The EV kit layout has been developed for packaged MAX3760s. 50Ω controlled impedance traces are used for the VOUT+ and VOUT- signal paths. Power and ground planes are relieved beneath the MAX3760 IN pin to reduce input capacitance.

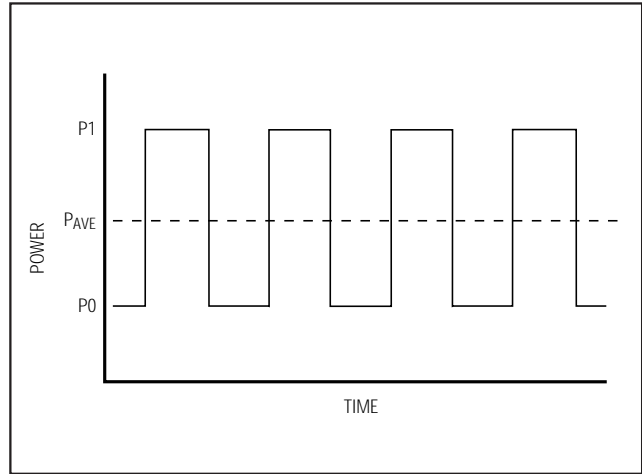

Figure 1. Optical Power Definitions

Evaluates: MAX3760

MAX3760 Evaluation Kit

Evaluates: MAX3760

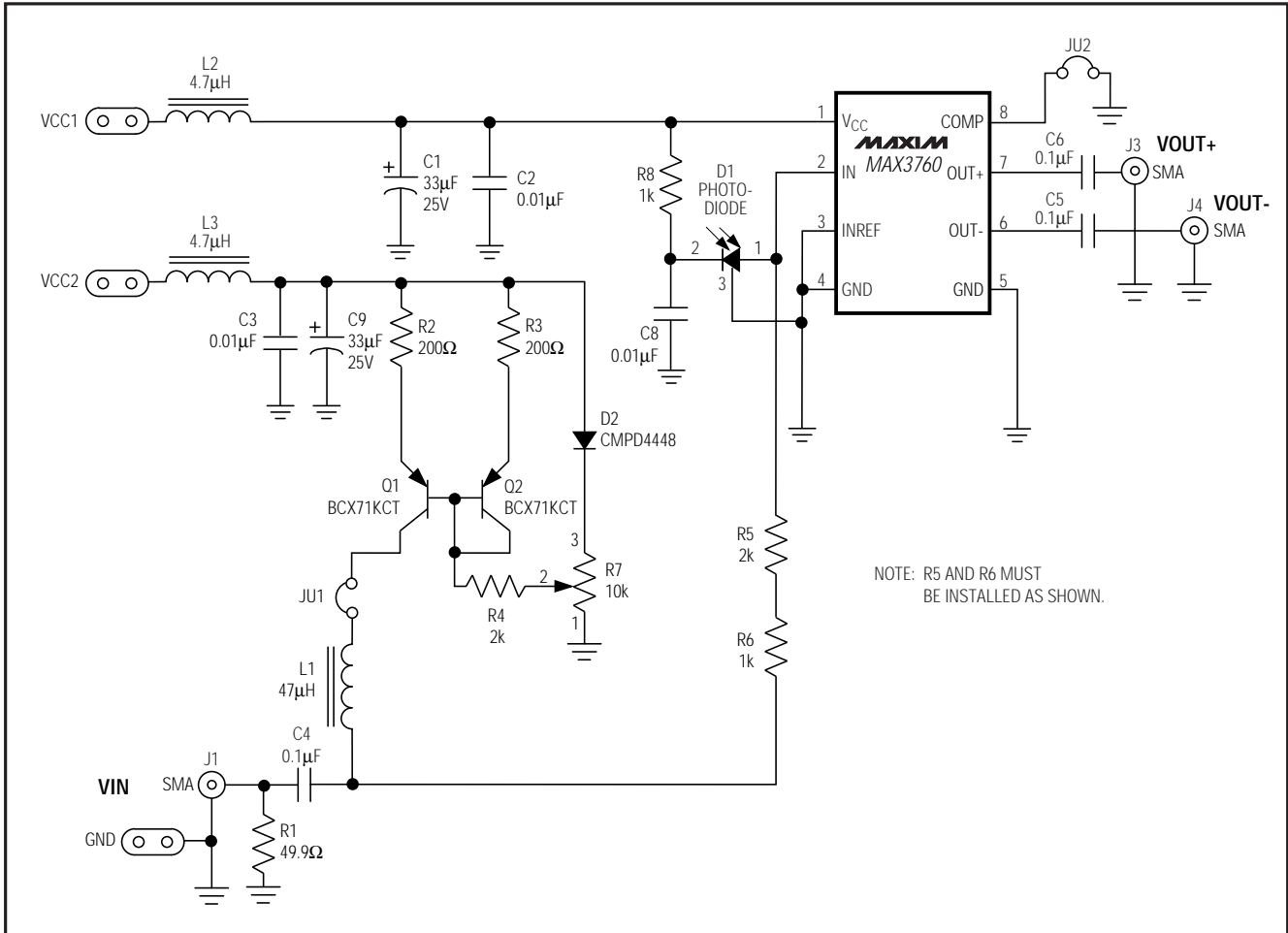

Figure 2. MAX3760 EV Kit Schematic

MAX3760 Evaluation Kit

Evaluates: MAX3760

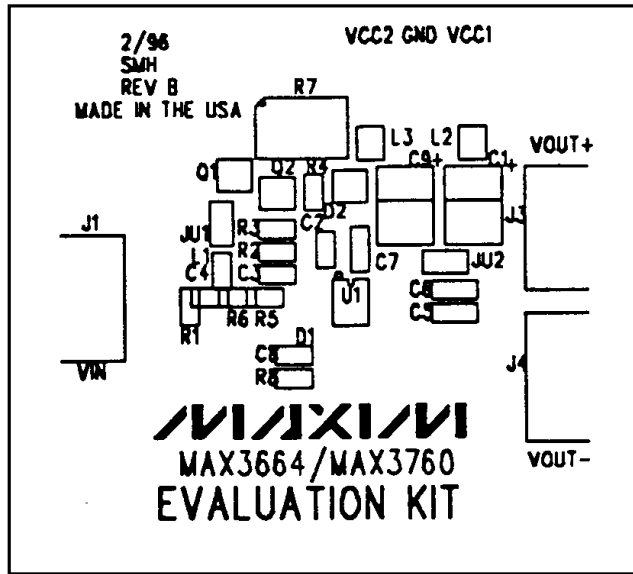

Figure 3. MAX3760 EV Kit Component Placement Guide—Component Side

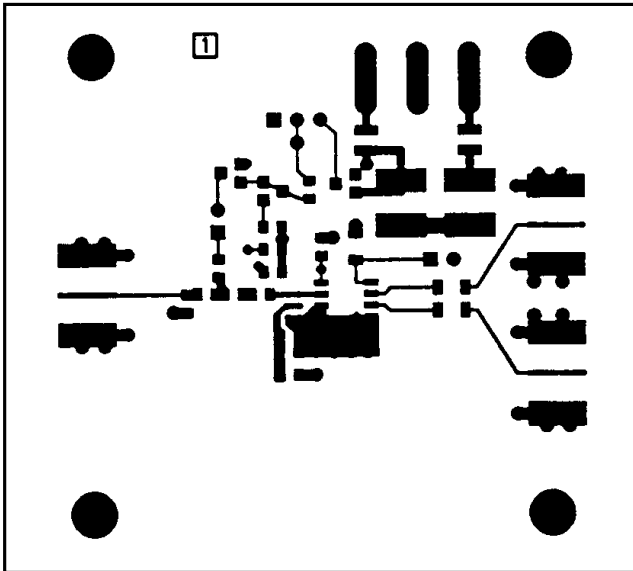

Figure 4. MAX3760 EV Kit PC Board Layout—Component Side

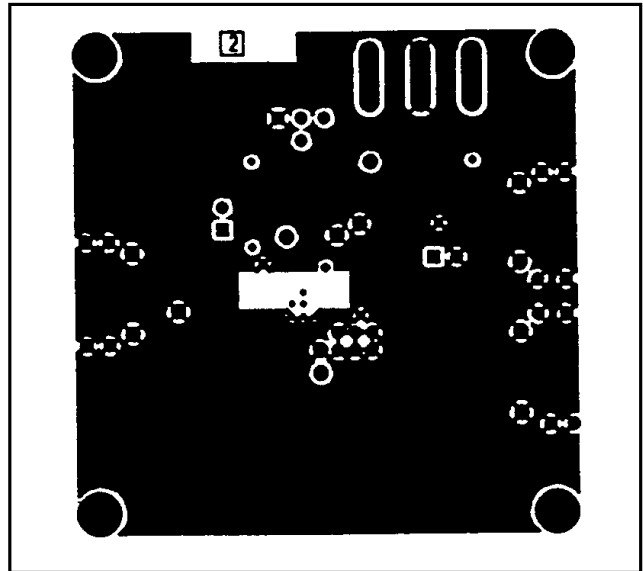

Figure 5. MAX3760 EV Kit PC Board Layout—Ground Plane

MAX3760 Evaluation Kit

Evaluates: MAX3760

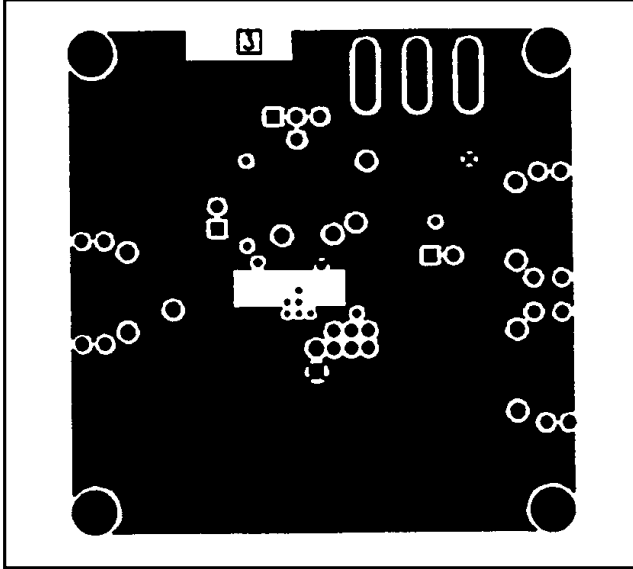

Figure 6. MAX3760 EV Kit PC Board Layout—Power Plane

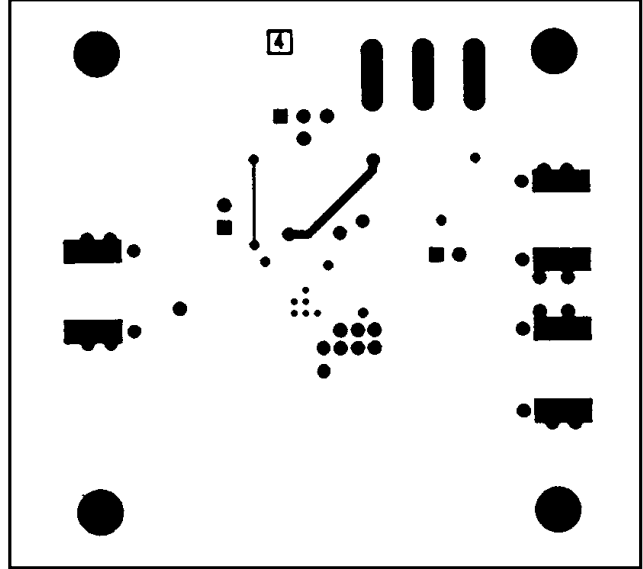

Figure 7. MAX3760 EV Kit PC Board Layout—Solder Side

MAX3760 Evaluation Kit

NOTES

Evaluates: MAX3760

MAX3760 Evaluation Kit

Evaluates: MAX3760

NOTES

Maxim cannot assume responsibility for use of any circuitry other than circuitry entirely embodied in a Maxim product. No circuit patent licenses are implied. Maxim reserves the right to change the circuitry and specifications without notice at any time.

8 _____ Maxim Integrated Products, 120 San Gabriel Drive, Sunnyvale, CA 94086 408-737-7600