

# Low Noise, Cascadable Silicon Bipolar MMIC Amplifier

## Technical Data

INA-01170

### Features

- **Cascadable 50 Ω Gain Block**
- **Low Noise Figure:**  
1.7 dB Typical at 100 MHz
- **High Gain:**  
32.5 dB Typical at 100 MHz
- **3 dB Bandwidth:**  
DC to 500 MHz
- **Unconditionally Stable**  
( $k > 1$ )
- **Hermetic Gold-Ceramic  
Surface Mount Package**

### Description

The INA-01170 is a low-noise silicon bipolar Monolithic Microwave Integrated Circuit (MMIC) feedback

amplifier housed in a hermetic, high reliability package. It is designed for narrow or wide bandwidth industrial and military applications that require high gain and low noise IF or RF amplification.

The INA series of MMICs is fabricated using HP's 10 GHz  $f_T$ , 25 GHz  $f_{MAX}$ , ISOSAT™-I silicon bipolar process which uses nitride self-alignment, submicrometer lithography, trench isolation, ion implantation, gold metallization and polyimide intermetal dielectric and scratch protection to achieve excellent performance, uniformity and reliability.

### 70 mil Package

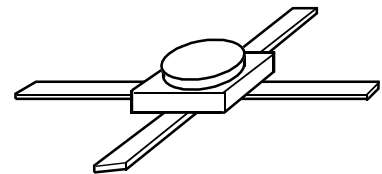

### Typical Biasing Configuration

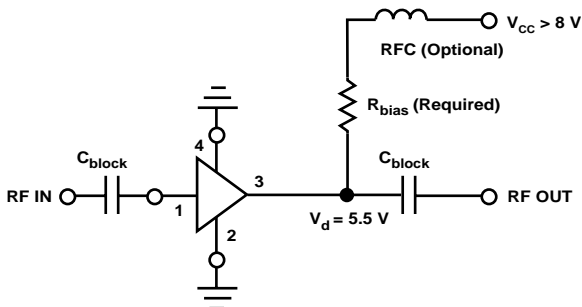

## INA-01170 Absolute Maximum Ratings

Parameter	Absolute Maximum <sup>[1]</sup>
Device Current	50 mA
Power Dissipation <sup>[2,3]</sup>	400 mW
RF Input Power	+13 dBm
Junction Temperature	200°C
Storage Temperature	-65 to 200°C

### Thermal Resistance<sup>[2,4]:</sup>

$$\theta_{jc} = 140^{\circ}\text{C/W}$$

#### Notes:

1. Permanent damage may occur if any of these limits are exceeded.
2.  $T_{\text{CASE}} = 25^{\circ}\text{C}$ .
3. Derate at  $7.1 \text{ mW}/^{\circ}\text{C}$  for  $T_{\text{C}} > 144^{\circ}\text{C}$ .
4. See MEASUREMENTS section "Thermal Resistance" for more information.

## INA-01170 Electrical Specifications<sup>[1]</sup>, $T_{\text{A}} = 25^{\circ}\text{C}$

Symbol	Parameters and Test Conditions: $I_{\text{d}} = 35 \text{ mA}$ , $Z_{\text{O}} = 50 \Omega$	Units	Min.	Typ.	Max.
$G_{\text{P}}$	Power Gain ( $ S_{21} ^2$ ) $f = 100 \text{ MHz}$	dB	30	32.5	35
$\Delta G_{\text{P}}$	Gain Flatness $f = 10 \text{ to } 250 \text{ MHz}$	dB		$\pm 0.5$	
$f_{3 \text{ dB}}$	3 dB Bandwidth <sup>[2]</sup>	MHz		500	
ISO	Reverse Isolation ( $ S_{12} ^2$ ) $f = 10 \text{ to } 250 \text{ MHz}$	dB		39	
VSWR	Input VSWR $f = 10 \text{ to } 250 \text{ MHz}$			1.6:1	
	Output VSWR $f = 10 \text{ to } 250 \text{ MHz}$			1.5:1	
NF	50 $\Omega$ Noise Figure $f = 100 \text{ MHz}$	dB		2.0	2.5
$P_{1 \text{ dB}}$	Output Power at 1 dB Gain Compression $f = 100 \text{ MHz}$	dBm		11	
$\text{IP}_3$	Third Order Intercept Point $f = 100 \text{ MHz}$	dBm		23	
$t_{\text{D}}$	Group Delay $f = 100 \text{ MHz}$	psec		200	
$V_{\text{d}}$	Device Voltage	V	4.0	5.5	7.0
dV/dT	Device Voltage Temperature Coefficient	mV/ $^{\circ}\text{C}$		+10	

#### Notes:

1. The recommended operating current range for this device is 30 to 40 mA. Typical performance as a function of current is on the following page.
2. Referenced from 10 MHz Gain ( $G_{\text{P}}$ ).

## INA-01170 Typical Scattering Parameters ( $Z_{\text{O}} = 50 \Omega$ , $T_{\text{A}} = 25^{\circ}\text{C}$ , $I_{\text{d}} = 35 \text{ mA}$ )

Freq. GHz	$S_{11}$		$S_{21}$			$S_{12}$			$S_{22}$		k
	Mag	Ang	dB	Mag	Ang	dB	Mag	Ang	Mag	Ang	
0.01	.09	-20	32.8	43.65	-2	-38.4	.012	-5	.17	-1	1.17
0.05	.10	-39	32.8	43.51	-9	-38.3	.012	17	.18	0	1.17
0.10	.13	-65	32.6	42.82	-18	-38.3	.012	-4	.18	1	1.17
0.15	.17	-83	32.4	41.71	-26	-38.4	.012	17	.19	2	1.18
0.20	.21	-96	32.1	40.41	-35	-38.6	.012	12	.19	3	1.18
0.25	.25	-107	31.8	38.93	-43	-39.0	.011	26	.19	4	1.26
0.30	.28	-115	31.5	37.38	-50	-39.0	.011	3	.20	5	1.26
0.40	.33	-130	30.7	34.19	-65	-39.3	.011	21	.21	3	1.31
0.50	.37	-140	29.9	31.13	-78	-39.2	.011	11	.22	0	1.35
0.60	.40	-150	29.0	28.30	-90	-38.9	.011	22	.23	-5	1.43
0.80	.43	-164	27.4	23.48	-112	-38.5	.012	30	.24	-19	1.52
1.0	.44	-176	25.8	19.45	-132	-36.5	.015	32	.23	-32	1.49
1.5	.44	165	21.8	12.37	-179	-33.6	.020	42	.19	-69	1.75
2.0	.44	154	17.9	7.88	146	-33.0	.022	42	.13	-106	2.42
2.5	.46	148	14.6	5.36	121	-30.6	.029	36	.12	-151	2.63
3.0	.48	139	11.4	3.71	96	-30.0	.032	45	.10	159	3.31

# INA-01170 Typical Performance, $T_A = 25^\circ\text{C}$

(unless otherwise noted)

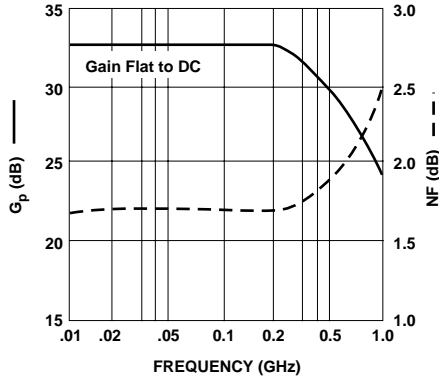

Figure 1. Typical Gain and Noise Figure vs. Frequency,  $T_A = 25^\circ\text{C}$ ,  $I_d = 35\text{ mA}$ .

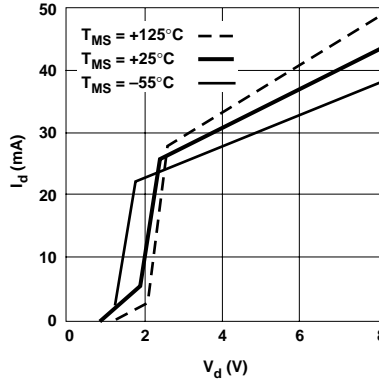

Figure 2. Device Current vs. Voltage.

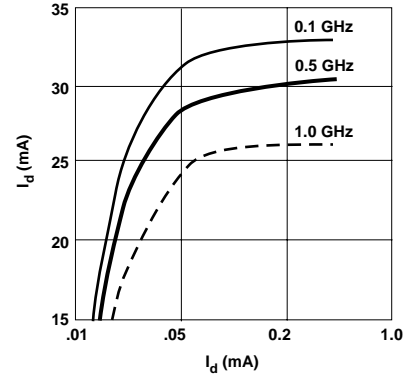

Figure 3. Power Gain vs. Current.

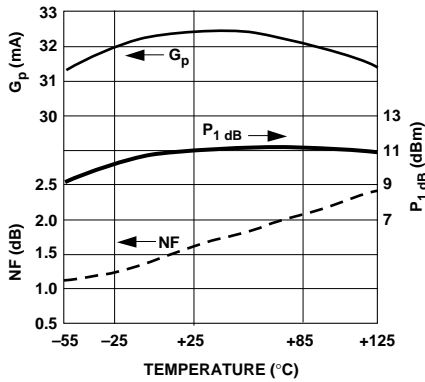

Figure 4. Output Power and 1 dB Gain Compression, NF and Power Gain vs. Case Temperature,  $f = 0.1\text{ GHz}$ ,  $I_d = 35\text{ mA}$ .

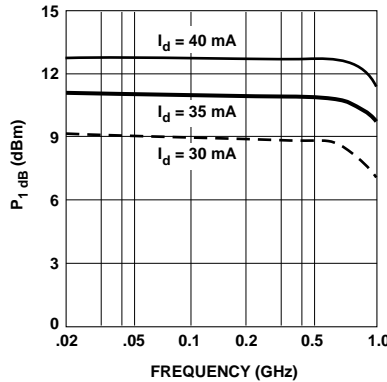

Figure 5. Output Power at 1 dB Gain Compression vs. Frequency.

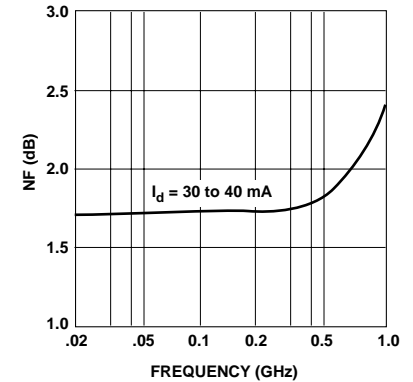

Figure 6. Noise Figure vs. Frequency.

## 70 mil Package Dimensions

