



128K x 36 SSRAM
SYNCHRONOUS ZBL SRAM
FLOW-THRU OUTPUT

FEATURES

- High frequency and 100% bus utilization
- Fast cycle times: 11ns & 12ns
- Single +3.3V $\pm 5\%$ power supply (V_{DD})
- Advanced control logic for minimum control signal interface
- Individual BYTE WRITE controls may be tied LOW
- Single R/W\ (READ/WRITE) control pin
- CKE\ pin to enable clock and suspend operations
- Three chip enables for simple depth expansion
- Clock-controlled and registered addresses, data I/Os and control signals
- Internally self-timed, fully coherent WRITE
- Internally self-timed, registered outputs to eliminate the need to control OE\
- SNOOZE MODE for reduced-power standby
- Common data inputs and data outputs
- Linear or Interleaved Burst Modes
- Burst feature (optional)
- Pin/function compatibility with 2Mb, 8Mb, and 16Mb ZBL SRAM
- Automatic power-down

OPTIONS

- Timing (Access/Cycle/MHz)
 - 8.5ns/11ns/90 MHz
 - 9ns/12ns/83 MHz
- Packages
 - 100-pin TQFP
- Operating Temperature Ranges
 - Military (-55°C to +125°C)
 - Industrial (-40°C to +85°C)

MARKING

- 11
- 12
- DQ No. 1001
- XT
- IT

GENERAL DESCRIPTION

The Austin Semiconductor, Inc. Zero Bus Latency SRAM family employs high-speed, low-power CMOS designs using an advanced CMOS process.

ASI's 4Mb ZBL SRAMs integrate a 128K x 36 SRAM core with advanced synchronous peripheral circuitry and a 2-bit burst counter. These SRAMs are optimized for 100 percent bus utilization, eliminating any turnaround cycles for READ to WRITE, or WRITE to READ, transitions. All synchronous inputs pass through registers controlled by a positive-edge-triggered single clock input (CLK). The synchronous inputs include all addresses, all data inputs, chip enable (CE\), two additional chip enables for easy depth expansion (CE2, CE2\), cycle start input (ADV/LD\), synchronous clock enable (CKE\), byte write enables (BWA\, BWB\, BWC\, and BWD\)) and read/write (R/W\).

Asynchronous inputs include the output enable (OE\), which may be tied LOW for control signal minimization), clock (CLK) and snooze enable (ZZ, which may be tied LOW if unused). There is also a burst mode pin (MODE) that selects between interleaved and linear burst modes. MODE may be tied HIGH, LOW or left unconnected if burst is unused. The flow-through data-out (Q) is enabled by OE\.

WRITE cycles can be from one to four bytes wide as controlled by the write control inputs. All READ, WRITE and DESELECT cycles are initiated by the ADV/LD\ input. Subsequent burst addresses can be internally generated as controlled by the burst advance pin (ADV/LD\).

Use of burst mode is optional. It is allowable to give an address for each individual READ and WRITE cycle. BURST cycles wrap around after the fourth access from a base address. To allow for continuous, 100 percent use of the data bus, the flow-through ZBL SRAM uses a LATE WRITE cycle. For example, if a WRITE cycle begins in clock cycle one, the address is present on rising edge one. BYTE WRITES need to be asserted on the same cycle as the address. The write data associated with the address is required one cycle later, or on the rising edge of clock cycle two.

Address and write control are registered on-chip to simplify WRITE cycles. This allows self-timed WRITE cycles. Individual byte enables allow individual bytes to be written. During a BYTE WRITE cycle, BWA\ controls DQa pins; BWB\ controls DQb pins; BWC\ controls DQc pins; and BWD\ controls DQd pins. Cycle types can only be defined when an address is loaded, i.e., when ADV/LD\ is LOW. Parity/ECC bits are available on this device.

Austin's 4Mb ZBL SRAMs operate from a +3.3V V_{DD} power supply, and all inputs and outputs are LVTTTL-compatible. The device is ideally suited for systems requiring high bandwidth and zero bus turnaround delays.

For more products and information
please visit our web site at
www.austinsemiconductor.com



PIN DESCRIPTIONS (continued)

TQFP PINS	SYMBOL	TYPE	DESCRIPTION
64	ZZ	Input	Snooze Enable: This active HIGH, asynchronous input causes the device to enter a low-power standby mode in which all data in the memory array is retained. When ZZ is active, all other inputs are ignored.
89	CLK	Input	Clock: This signal registers the address, data, chip enables, byte write enables and burst control inputs on its rising edge. All synchronous inputs must meet setup and hold times around the clock's rising edge.
98, 92	CE \setminus , CE2 \setminus	Input	Synchronous Chip Enable: These active LOW inputs are used to enable the device and are sampled only when a new external address is loaded (ADV/LD \setminus LOW). CE2 \setminus can be used for memory depth expansion.
97	CE2	Input	Synchronous Enable: This active HIGH input is used to enable the device and is sampled only when a new external address is loaded (ADV/LD \setminus LOW). This input can be used for memory depth expansion.
86	OE \setminus (G \setminus)	Input	Output Enable: This active LOW, asynchronous inputs enables the data I/O output drivers. G \setminus is the JEDEC-standard term for OE \setminus .
85	ADV/LD \setminus	Input	Synchronous Address Advance/Load: When HIGH, this input is used to advance the internal burst counter, controlling burst access after the external address is loaded. When ADV/LD \setminus is HIGH, R/W is ignored. A LOW on ADV/LD \setminus clocks a new address at the CLK rising edge.
31	MODE (LBO \setminus)	Input	Mode: This inputs selects the burst sequence. A LOW on this pin selects linear burst. NC or HIGH on this pin selects interleaved burst. Do not alter input state while device is operating. LBO \setminus is the JEDEC-standard term for MODE.
(a) 51, 52, 53, 56-59, 62, 63 (b) 68, 69, 72-75, 78, 79, 80 (c) 1, 2, 3, 6-9, 12, 13 (d) 18, 19, 22-25, 28, 29, 30	DQa DQb DQc DQd	Input/Output	SRAM Data I/Os: Byte "a" is DQa pins; Byte "b" is DQb pins; Byte "c" is DQc pins; Byte "d" is DQd pins. Input data must meet setup and hold times around the rising edge CLK.
15, 16, 41, 65, 91	V _{DD}	Supply	Power Supply: See DC Electrical Characteristics and Operating Conditions for range.
5, 10, 14, 17, 21, 26 40, 55, 60, 66, 67, 71 76, 90	V _{SS}	Ground	Ground: GND
4, 11, 20, 27, 54, 61 70, 77	V _{DDQ}	Supply	Isolated Output Buffer Supply: See DC Electrical Characteristics and Operating Conditions for range.
38, 39, 42, 43, 83, 84 64	NC	----	No Connect: These pins can be left floating or connected to GND to minimize thermal impedance.
38, 39, 42, 43	DNU	----	Do Not Use: These signals may with be unconnected or wired to GND to minimize thermal impedance.
83, 84	NF	----	No Function: These pins are internally connected to the die and will have the capacitance of an input pin. It is allowable to leave these pins unconnected or driven by signals. Pins 83 and 84 are reserved for address expansion.



INTERLEAVED BURST ADDRESS TABLE (MODE = NC OR HIGH)

First Address (external)	Second Address (internal)	Third Address (internal)	Fourth Address (internal)
X...X00	X...X01	X...X10	X...X11
X...X01	X...X00	X...X11	X...X10
X...X10	X...X11	X...X00	X...X01
X...X11	X...X10	X...X01	X...X00

LINEAR BURST ADDRESS TABLE (MODE = LOW)

First Address (external)	Second Address (internal)	Third Address (internal)	Fourth Address (internal)
X...X00	X...X01	X...X10	X...X11
X...X01	X...X10	X...X11	X...X00
X...X10	X...X11	X...X00	X...X01
X...X11	X...X00	X...X01	X...X10

PARTIAL TRUTH TABLE FOR READ/WRITE COMMANDS*

FUNCTION	R/W\	BWa\	BWb\	BWc\	BWd\
READ	H	X	X	X	X
Write Abort/NOP	L	H	H	H	H
Write Byte a (DQa, DQP _a) ²	L	L	H	H	H
Write Byte b (DQb, DQP _b) ²	L	H	L	H	H
Write Byte c (DQc, DQP _c) ²	L	H	H	L	H
Write Byte d (DQd, DQP _d) ²	L	H	H	H	L
Write all bytes	L	L	L	L	L

* **NOTE:** Using R/W\ and byte write(s), any one or more bytes may be written.



FUNCTIONAL BLOCK DIAGRAM

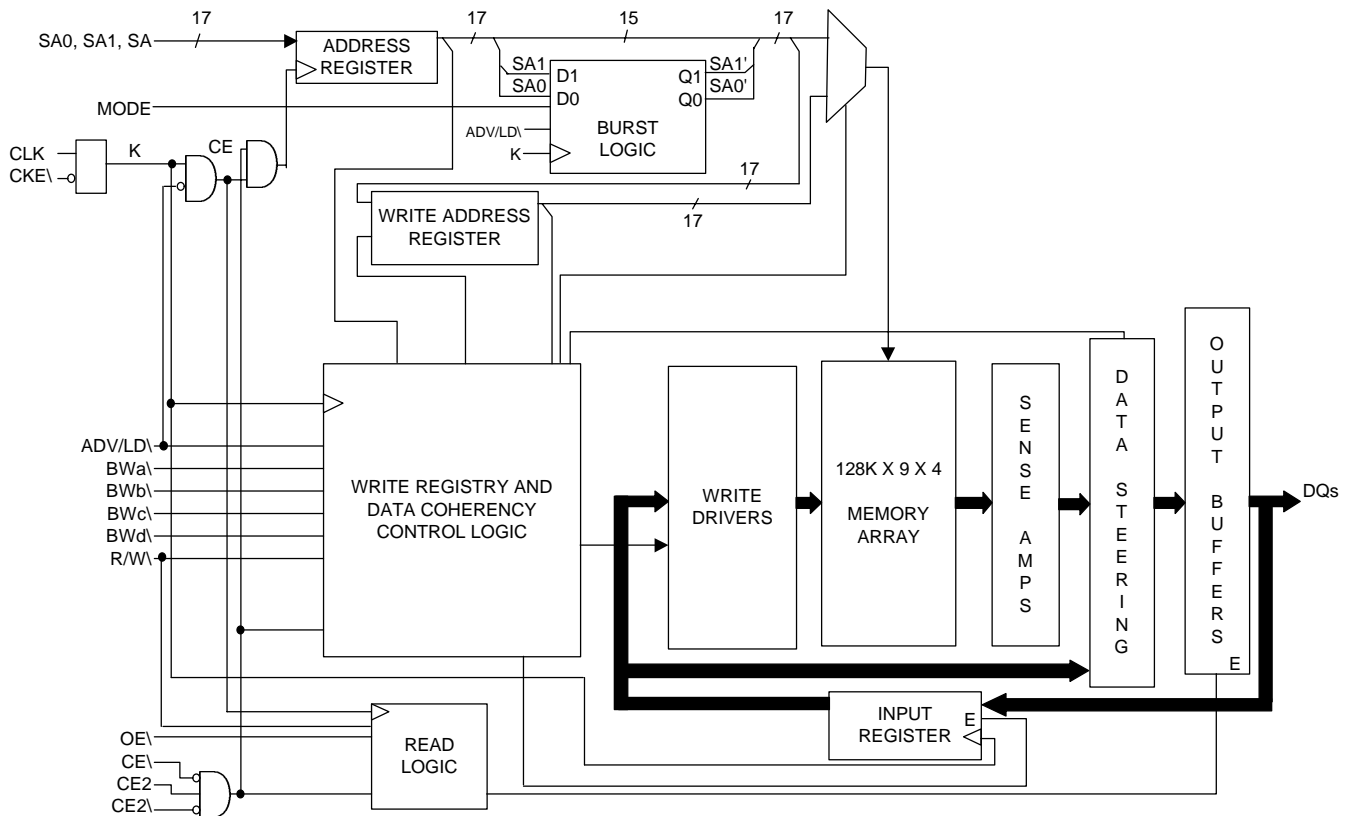

NOTE: The Functional Block Diagram illustrates simplified device operation. See Truth Table, pin descriptions and timing diagrams for detailed information.



STATE DIAGRAM FOR ZBL SRAM

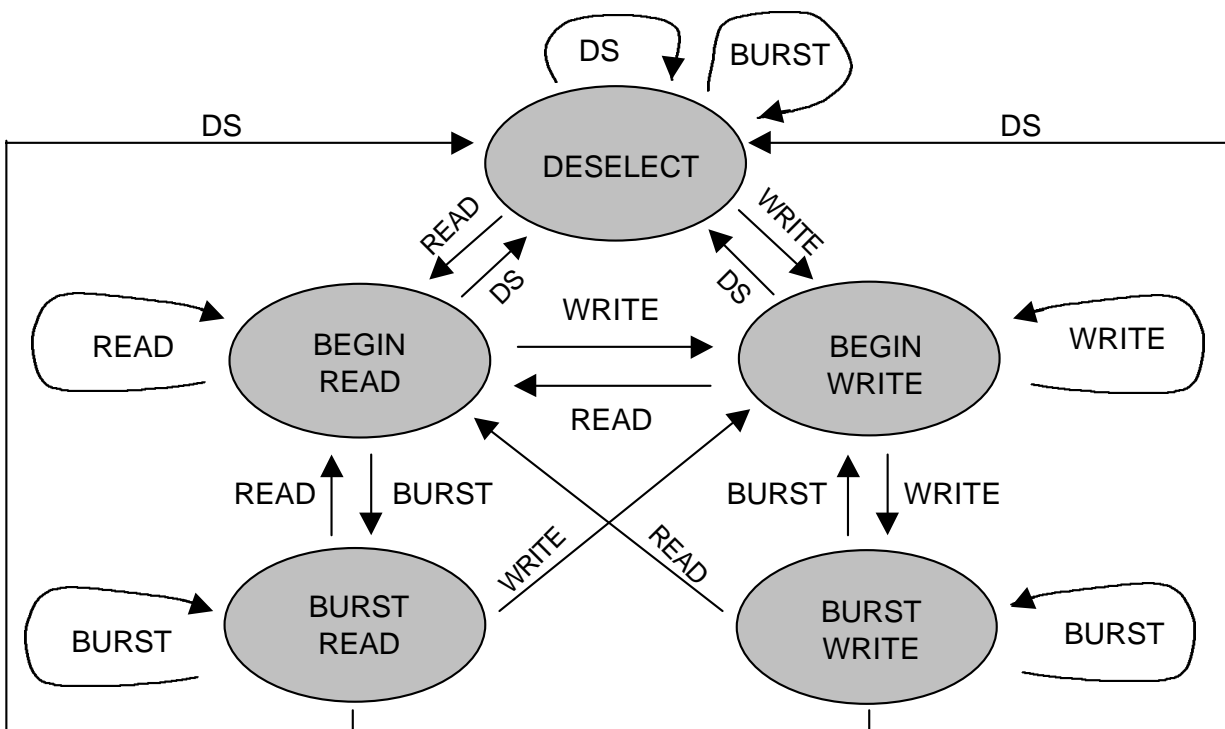

KEY:

COMMAND	ACTION
DS	DESELECT
READ	New READ
WRITE	New WRITE
BURST	BURST READ, BURST WRITE or CONTINUE DESELECT

- NOTE:**
1. A STALL or IGNORE CLOCK EDGE cycle is not shown in the above diagram. This is because CKE\ HIGH only blocks the clock (CLK) input and does not change the state of the device.
 2. States change on the rising edge of the clock (CLK).



TRUTH TABLE (5-10)

OPERATION	ADDRESS USED	CE\	CE2\	CE2	ZZ	ADV/LD\	R/W\	BWx	OE\	CKE\	CLK	DQ	NOTES
DESELECT CYCLE	None	H	X	X	L	L	X	X	X	L	L→H	High-Z	
DESELECT CYCLE	None	X	H	X	L	L	X	X	X	L	L→H	High-Z	
DESELECT CYCLE	None	X	X	L	L	L	X	X	X	L	L→H	High-Z	
CONTINUE DESELECT CYCLE	None	X	X	X	L	H	X	X	X	L	L→H	High-Z	1
READ CYCLE (Begin Burst)	External	L	L	H	L	L	H	X	L	L	L→H	Q	
READ CYCLE (Continue Burst)	Next	X	X	X	L	H	X	X	L	L	L→H	Q	1, 11
NOP/DUMMY READ (Begin Burst)	External	L	L	H	L	L	H	X	H	L	L→H	High-Z	2
DUMMY READ (Continue Burst)	Next	X	X	X	L	H	X	X	H	L	L→H	High-Z	1, 2, 11
WRITE CYCLE (Begin Burst)	External	L	L	H	L	L	L	L	X	L	L→H	D	3
WRITE CYCLE (Continue Burst)	Next	X	X	X	L	H	X	L	X	L	L→H	D	1, 3, 11
NOP/WRITE ABORT (Begin Burst)	None	L	L	H	L	L	L	H	X	L	L→H	High-Z	2, 3
WRITE ABORT (Continue Burst)	Next	X	X	X	L	H	X	H	X	L	L→H	High-Z	1, 2, 3, 11
IGNORE CLOCK EDGE (Stall)	Current	X	X	X	L	X	X	X	X	H	L→H	---	4
SNOOZE MODE	None	X	X	X	H	X	X	X	X	X	X	High-Z	

NOTE:

1. CONTINUE BURST cycles, whether READ or WRITE, use the same control inputs. The type of cycle performed (READ or WRITE) is chosen in the initial BEGIN BURST cycle. A CONTINUE DESELECT cycle can only be entered if a DESELECT cycle is first executed.
2. DUMMY READ and WRITE ABORT cycles can be considered NOPs because the device performs no external operation. A WRITE ABORT means a WRITE command is given, but no operation is performed.
3. OE\ may be wired LOW to minimize the number of control signals to the SRAM. The device will automatically turn off the output drivers during a WRITE cycle. OE\ may be used when the bus turn-on and turn-off times do not meet an applications requirements.
4. If an IGNORE CLOCK EDGE command occurs during a READ operation, the DQ bus will remain active (Low-Z). If it occurs during a WRITE cycle, the bus will remain in High-Z. No WRITE operations will be performed during the IGNORE CLOCK EDGE cycle.
5. X means "Don't Care." H means logic HIGH. L means logic LOW. BWx = H means all byte write signals (BWA\, BWb\, BWc\, BWd\) are HIGH. BWx = L means all byte write signals are LOW.
6. BWA\ enables WRITES to Byte "a" (DQa pins); BWb\ enables WRITES to Byte "b" (DQb pins); BWc\ enables WRITES to Byte "c" (DQc pins); BWd\ enables WRITES to Byte "d" (DQd pins).
7. All inputs except OE\ and ZZ must meet setup and hold times around the rising edge (LOW to HIGH) of CLK.
8. Wait states are inserted by setting CKE\ HIGH.
9. This device contains circuitry that will ensure that the outputs will be in the High-Z during power-up.
10. The device incorporates a 2-bit burst counter. Address wraps to the initial address every fourth BURST cycle.
11. The address counter is incremented for all CONTINUE BURST cycles.



ABSOLUTE MAXIMUM RATINGS*

Voltage on V_{DD} Supply Relative to V_{SS}.....-0.5V to +4.6V
 Voltage on V_{DD}Q Supply Relative to V_{SS}.....-0.5V to V_{DD}
 V_{IN}.....-0.5V to V_{DD}Q+0.5V
 Storage Temperature (Plastics)-55°C to +150°C
 Short Circuit Output Current100mA
 Max. Junction Temperature*.....+150°C

*Stresses greater than those listed under "Absolute Maximum Ratings" may cause permanent damage to the device. This is a stress rating only and functional operation of the device at these or any other conditions above those indicated in the operation section of this specification is not implied. Exposure to absolute maximum rating conditions for extended periods may affect reliability.
 **Junction Temperature depends upon package type, cycle time, loading, ambient temperature and airflow.

DC ELECTRICAL CHARACTERISTICS AND RECOMMENDED OPERATING CONDITIONS

(-55°C ≤ T_A ≤ +125°C; V_{DD}, V_{DD}Q = +3.3V ±0.165V unless otherwise noted)

DESCRIPTION	CONDITIONS	SYMBOL	MIN	MAX	UNITS	NOTES
Input High (Logic 1) Voltage		V _{IH}	2.0	V _{DD} + 0.3	V	1, 2
Input High (Logic 1) Voltage	DQ Pins	V _{IH}	2.0	V _{DD} + 0.3	V	1, 2
Input Low (Logic 0) Voltage		V _{IL}	-0.3	0.8	V	1, 2
Input Leakage Current	0V ≤ V _{IN} ≤ V _{DD}	I _{LI}	-1.0	1.0	µA	3
Output Leakage Current	Output(s) Disabled, 0V ≤ V _{IN} ≤ V _{DD}	I _{LO}	-1.0	1.0	µA	
Output High Voltage	I _{OH} = -4.0mA	V _{OH}	2.4	---	V	1, 4
Output Low Voltage	I _{OL} = 8.0mA	V _{OL}	---	0.4	V	1, 4
Supply Voltage		V _{DD}	3.135	3.465	V	1
Isolated Output Buffer Supply		V _{DD} Q	3.135	V _{DD}	V	1, 5

CAPACITANCE

DESCRIPTION	CONDITIONS	SYMBOL	TYP	MAX	UNITS	NOTES
Control Input Capacitance	T _A = 25°C; f = 1 MHz V _{DD} = 3.3V	C _I	3	4	pF	6
Input/Output Capacitance (DQ)		C _O	4	5	pF	6
Address Capacitance		C _A	3	3.5	pF	6
Clock Capacitance		C _{CK}	3	3.5	pF	6

NOTE:

- All voltages referenced to V_{SS} (GND).
- Overshoot: V_{IH} ≤ +4.6V for t ≤ t_{KHKH} / 2 for I ≤ 20mA.
 Undershoot: V_{IL} ≤ -0.7V for t ≤ t_{KHKH} / 2 for I ≤ 20mA.
 Power-up: V_{IH} ≤ +3.465V and V_{DD} ≤ 3.135V for t ≤ 200ms.
- MODE pin has an internal pull-up, and input leakage = ± 10µA.
- The load used for V_{OH}, V_{OL} testing is shown in Figure 2. AC load current is higher than the shown DC values. AC I/O curves are available upon request.
- V_{DD}Q should never exceed V_{DD}. V_{DD} and V_{DD}Q should be externally wired together to the same power supply.
- This parameter is sampled.



I_{DD} OPERATING CONDITIONS AND MAXIMUM LIMITS

(-55°C ≤ T_A ≤ +125°C; V_{DD}, V_{DD}Q = +3.3V ±0.165V unless otherwise noted)

DESCRIPTION	CONDITIONS	SYM	MAX		UNITS	NOTES
			-11	-12		
Power Supply Current: Operating	Device selected; All inputs ≤ V _{IL} or ≥ V _{IH} ; Cycle time ≥ t _{KC} (MIN) V _{DD} = MAX; Outputs open	I _{DD}	275	250	mA	1, 2
Power Supply Current: Idle	Device selected; V _{DD} = MAX; CKE\ ≥ V _{IH} ; All inputs ≤ V _{SS} + 0.2 or ≥ V _{DD} -0.2; Cycle time ≥ t _{KC} (MIN)	I _{DD1}	22	20	mA	1, 2
CMOS Standby	Device selected; V _{DD} = MAX; All inputs ≤ V _{SS} + 0.2 or ≥ V _{DD} -0.2; All inputs static; CLK frequency = 0	I _{SB2}	10	10	mA	2
TTL Standby	Device selected; V _{DD} = MAX; All inputs ≤ V _{IL} or ≥ V _{IH} ; All inputs static; CLK frequency = 0	I _{SB3}	25	25	mA	2
Clock Running	Device selected; V _{DD} = MAX; ADV/LD\ ≥ V _{IH} ; All inputs ≤ V _{SS} + 0.2 or ≥ V _{DD} - 0.2; Cycle time ≥ t _{KC} (MIN)	I _{SB4}	65	60	mA	2
Snooze Mode	ZZ ≥ V _{IH}	I _{SB2Z}	10	10	mA	2

THERMAL RESISTANCE

DESCRIPTION	CONDITIONS	SYM	TYP	UNITS	NOTES
Thermal Resistance (Junction to Ambient)	Test conditions follow standard test methods and procedures for measuring thermal impedance, per EIA/JESD51	θ _{JA}	46	°C/W	3
Thermal Resistance (Junction to Top of Case)		θ _{JC}	2.8	°C/W	3

NOTE:

- I_{DD} is specified with no output current and increases with faster cycle times. I_{DD}Q increases with faster cycle times and greater output loading.
- “Device deselected” means device is in a deselected cycle as defined in the truth table. “Device selected” means device is active (not in deselected mode).
- This parameter is sampled.



AC ELECTRICAL CHARACTERISTICS 6, 8, 9

($-55^{\circ}\text{C} \leq T_A \leq +125^{\circ}\text{C}$; $V_{DD}, V_{DDQ} = +3.3\text{V} \pm 0.165\text{V}$)

DESCRIPTION	SYM	-11		-12		UNITS	NOTES
		MIN	MAX	MIN	MAX		
CLOCK							
Clock cycle time	t_{KHKH}	11		12		ns	
Clock frequency	t_{KF}		90		83	MHz	
Clock HIGH time	t_{KHKL}	3.0		3.0		ns	1
Clock LOW time	t_{KLKH}	3.0		3.0		ns	1
OUTPUT TIMES							
Clock to output valid	t_{KHQV}		8.5		9.0	ns	
Clock to output invalid	t_{KHQX}	3.0		3.0		ns	2
Clock to output in Low-Z	t_{KHQX1}	3.0		3.0		ns	2, 3, 4, 5
Clock to output in High-Z	t_{KHQZ}		5.0		5.0	ns	2, 3, 4, 5
OE\ to output valid	t_{GLQV}		5.0		5.0	ns	6
OE\ to output in Low-Z	t_{GLQX}	0		0		ns	2, 3, 4, 5
OE\ to output in High-Z	t_{GHQZ}		5.0		5.0	ns	2, 3, 4, 5
SETUP TIMES							
Address	t_{AVKH}	2.2		2.5		ns	7
Clock enable (CKE\)	t_{EVKH}	2.2		2.5		ns	7
Control signals	t_{CVKH}	2.2		2.5		ns	7
Data-in	t_{DVKH}	2.2		2.5		ns	7
HOLD TIMES							
Address	t_{KHAX}	0.5		0.5		ns	7
Clock enable (CKE\)	t_{KHEX}	0.5		0.5		ns	7
Control signals	t_{KHXC}	0.5		0.5		ns	7
Data-in	t_{KHDX}	0.5		0.5		ns	7

NOTE:

1. Measured as HIGH above V_{IH} and LOW below V_{IL} .
2. Contact ASI for more information on these parameters.
3. This parameter is sampled.
4. This parameter is measured with the output loading shown in Figure 2.
5. Transition is measured $\pm 200\text{mV}$ from steady state voltage.
6. OE\ can be considered a "Don't Care" during WRITES; however, controlling OE\ can help fine-tune a system for ZBL timing.
7. This is a synchronous device. All addresses must meet the specified setup and hold times for all rising edges of CLK when they are being registered into the device. All other synchronous inputs must meet the setup and hold times with stable logic levels for all rising edges of clock (CLK) when the chip is enabled. Chip enable must be valid at each rising edge of CLK when ADV/LD\ is LOW to remain enabled.
8. Test conditions as specified with the output loading shown in Figure 1, unless otherwise noted.
9. A WRITE cycle is defined by R/W\ LOW having been registered into the device at ADV/LD\ LOW. A READ cycle is defined by R/W\ HIGH with ADV/LD\ LOW. Both cases must meet setup and hold times.



AC TEST CONDITIONS

Input pulse levels	Vss to 3.3V
Input slew rate	1 ns
Input timing reference levels	1.5V
Output reference levels	1.5V
Output load	See Figures 1 and 2

OUTPUT LOADS

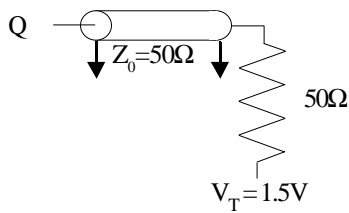

Fig. 1 OUTPUT LOAD EQUIVALENT

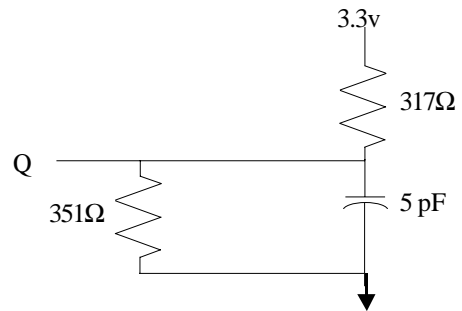

Fig. 2 OUTPUT LOAD EQUIVALENT

LOAD DERATING CURVES

The ASI 128K x 36 ZBL SRAM timing is dependent upon the capacitive loading on the outputs.

Consult the factory for copies of I/O current versus voltage curves.



SNOOZE MODE

SNOOZE MODE is a low-current, “power-down” mode in which the device is deselected and current is reduced to I_{SB2Z} . The duration of SNOOZE MODE is dictated by the length of time the ZZ pin is in a HIGH state. After the device enters SNOOZE MODE, all inputs except ZZ become disabled and all outputs go to High-Z.

The ZZ pin is an asynchronous, active HIGH input that causes the device to enter SNOOZE MODE. When the ZZ pin

becomes a logic HIGH, I_{SB2Z} is guaranteed after the time t_{ZZI} is met. Any READ or WRITE operation pending when the device enters SNOOZE MODE is not guaranteed to complete successfully. Therefore, SNOOZE MODE must not be initiated until valid pending operations are completed. Similarly, when exiting SNOOZE MODE during t_{RZZ} , only a DESELECT or READ cycle should be given.

SNOOZE MODE ELECTRICAL CHARACTERISTICS

DESCRIPTION	CONDITIONS	SYM	MIN	MAX	UNITS	NOTES
Current during SNOOZE MODE	$ZZ \geq V_{IH}$	I_{SB2Z}		10	mA	
ZZ active to input ignored		t_{ZZ}	0	t_{KHKH}	ns	1
ZZ inactive to input sampled		t_{RZZ}	0	t_{KHKH}	ns	1
ZZ active to snooze current		t_{ZZI}		t_{KHKH}	ns	1
ZZ inactive to exit snooze current		t_{RZZI}	0		ns	1

SNOOZE MODE WAVEFORM

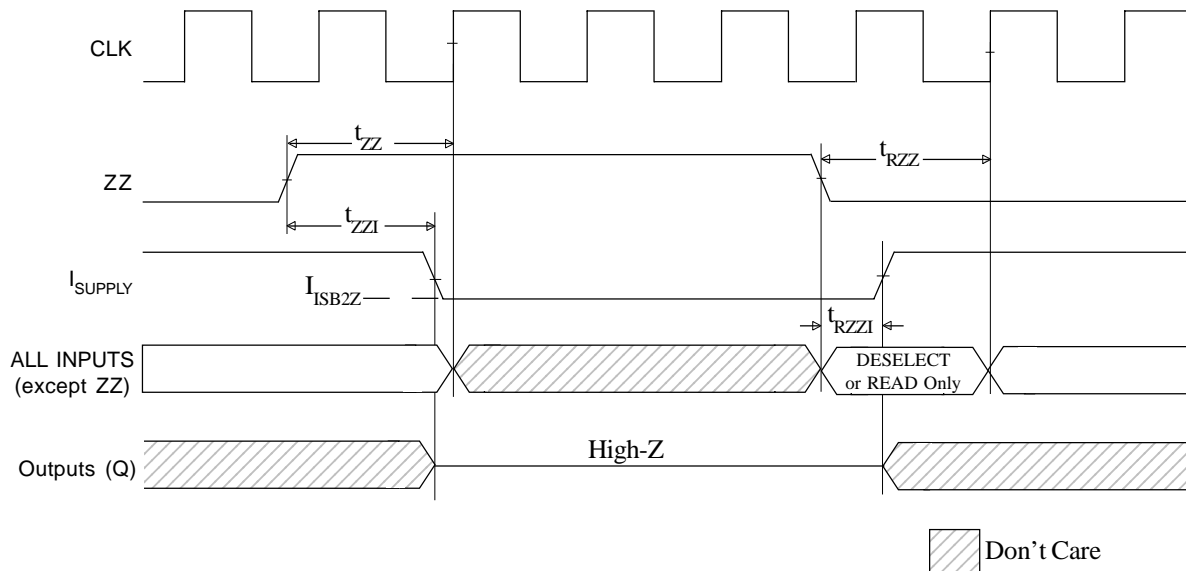



NOP, STALL AND DESELECT CYCLES

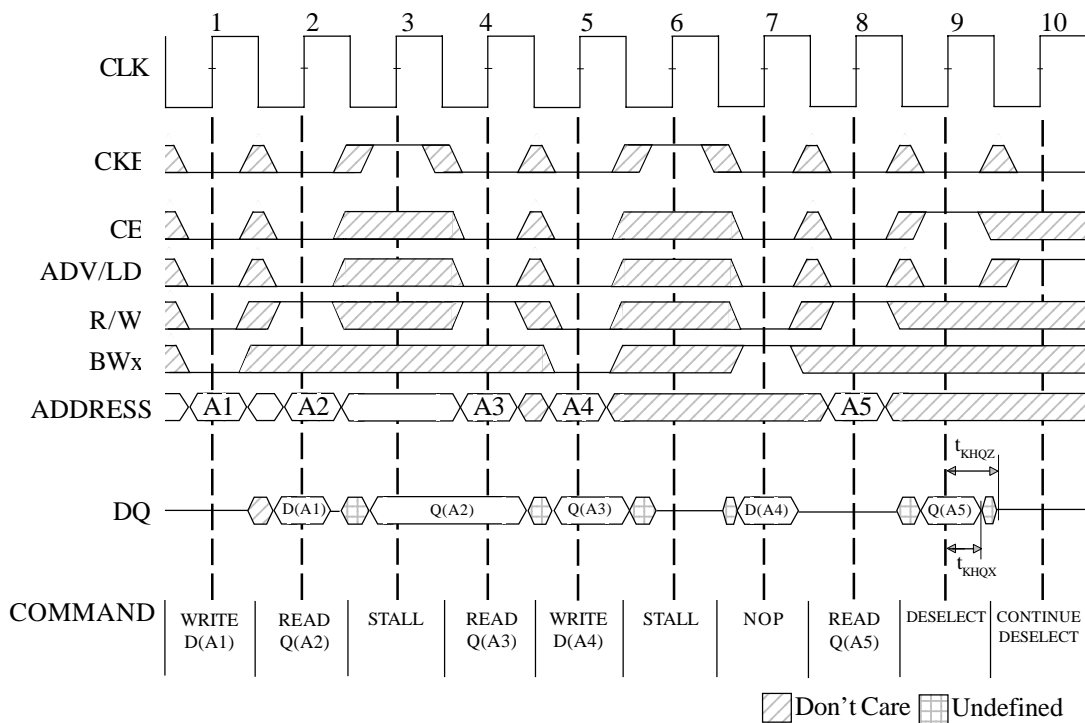

NOP, STALL AND DESELECT TIMING PARAMETERS

SYMBOL	-11		-12	
	MIN	MAX	MIN	MAX
t _{KHQX}	3.0		3.0	
t _{KHQZ}		5.0		5.0

NOTE:

1. The IGNORE CLOCK EDGE or STALL cycle (clock 3) illustrates CKE\ being used to create a “pause”. A WRITE is not performed during this cycle.
2. For this waveform, ZZ and OE\ are tied LOW.
3. CE\ represents three signals. When CE\ = 0, it represents CE\ = 0, CE2\ = 0, CE2 = 1.
4. Data coherency is provided for all possible operations. If a READ is initiated, the most current data is used. The most recent data may be from the input data register.



Austin Semiconductor, Inc.

SRAM
AS5SS128K36

ASI Case # 1001 (Package Designator DQ)

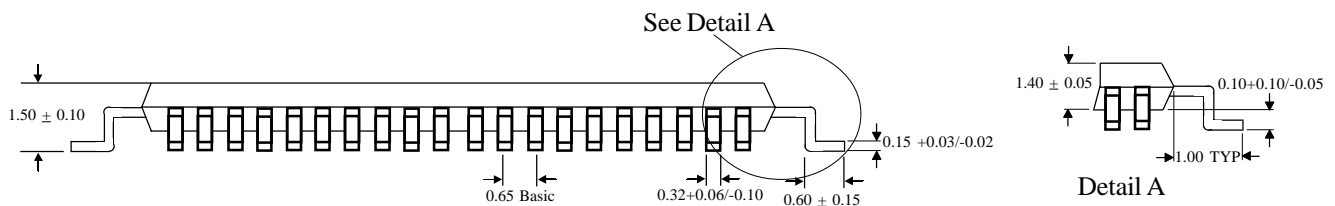
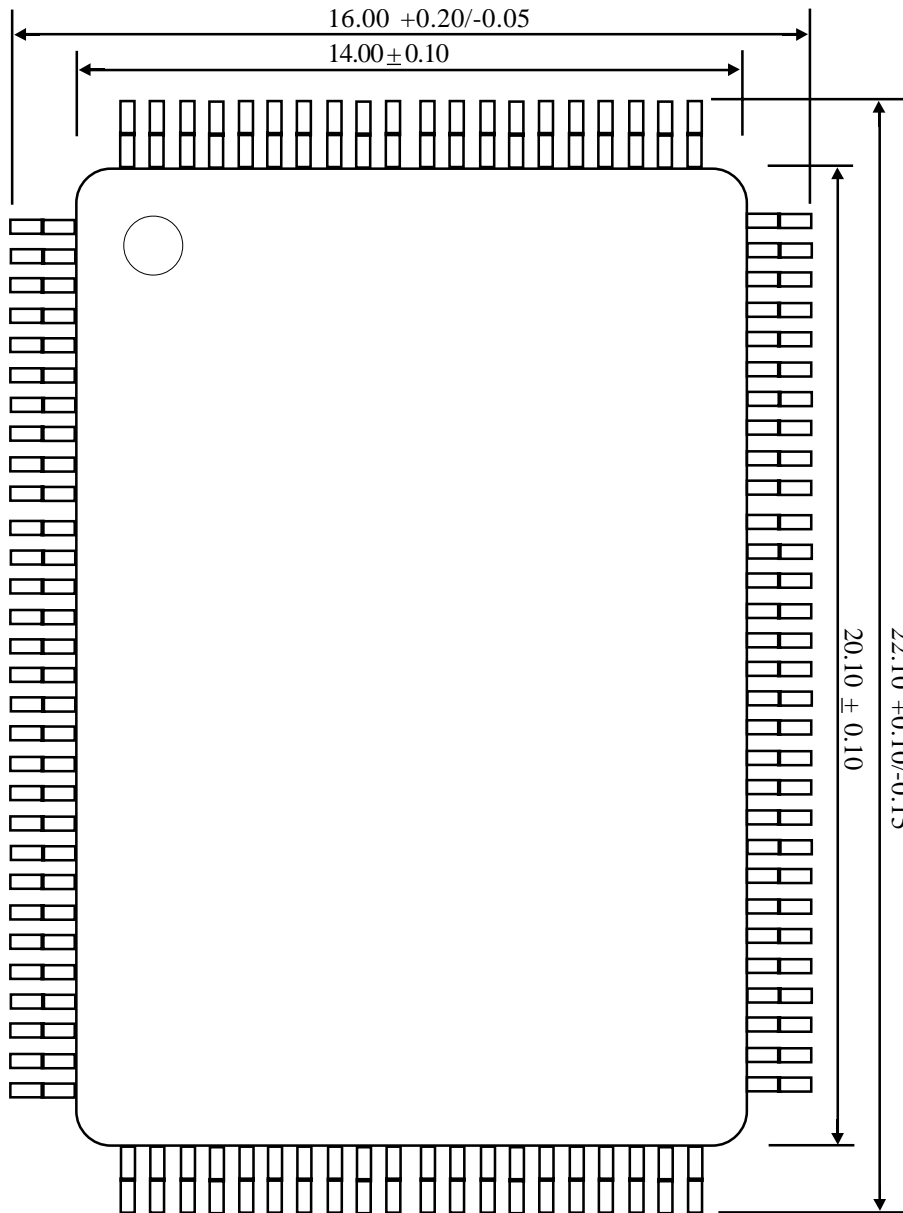

NOTE: All dimensions in Millimeters.



ORDERING INFORMATION

EXAMPLE: AS5SS128K36DQ-11/IT

Device Number	Package Type	Speed ns	Process
AS5SS128K36	DQ	-11	/*
AS5SS128K36	DQ	-12	/*

*AVAILABLE PROCESSES

IT = Industrial Temperature Range

-40°C to +85°C

XT = Extended Temperature Range

-55°C to +125°C