

Features

- Metal shaft and bushing
 - Consistent, smooth quality feel
 - Up to 4 sections available
 - Rotary switch option designed for "on-off" function control
- RoHS compliant versions available*

81/82 - 5/8 " Square Single-Turn Panel Control

85/86 - 5/8 " Square Single-Turn Panel Control with Rotary Switch

Potentiometer Specifications

Initial Electrical Characteristics ¹	Conductive Plastic Element	Cermet Element
Standard Resistance Range		
Linear Tapers (A, B, E, & H).....	(B & E) 1 K ohms to 1 megohm.....	(A & H) 100 ohms to 1 megohm
Audio Tapers (C, D, F, G, S, & T).....	(D, G, S, & T) 1 K ohms to 1 megohm.....	(C & F) 1 K ohms to 1 megohm
Total Resistance Tolerance.....	±20 % or 10 %.....	±10 % or 5 %
Independent Linearity.....	±5 %.....	±5 %
Absolute Minimum Resistance.....	2 ohms maximum.....	2 ohms maximum
Effective Electrical Angle.....	(Linear tapers) 240 ° ± 5 °.....	(Linear tapers) 240 ° ± 6 °
	(Audio tapers) 225 ° ± 5 °.....	(Audio tapers) 225 ° ± 6 °
Contact Resistance Variation.....	±1 %.....	±1 % or 3 ohms (whichever is greater)
Dielectric Withstanding Voltage (MIL-STD-202, Method 301)		
Sea Level.....	1,500 VAC minimum.....	1,500 VAC minimum
70,000 Feet.....	500 VAC minimum.....	500 VAC minimum
Insulation Resistance (500 VDC).....	1,000 megohms minimum.....	1,000 megohms minimum
Power Rating At 70 °C (Voltage Limited By Power Dissipation or 350 VAC, Whichever Is Less)		
+70 °C Single Section Assembly.....	(Linear tapers) 0.5 watt.....	(Linear tapers) 2 watts
	(Audio tapers) 0.25 watt.....	(Audio tapers) 1 watt
+70 °C Multiple Section Assembly.....	(Linear tapers) 0.5 watt/section.....	(Linear tapers) 1 watt/section
	(Audio tapers) 0.25 watt/section.....	(Audio tapers) 0.5 watt/section
+125 °C.....	0 watt.....	0 watt
Theoretical Resolution.....	Essentially infinite.....	Essentially infinite

Environmental Characteristics¹

Operating Temperature Range.....	-40 °C to +125 °C.....	-40 °C to +125 °C
Storage Temperature Range.....	-55 °C to +125 °C.....	-55 °C to +125 °C
Temperature Coefficient Over Storage Temperature Range.....	±1,000 ppm/°C.....	±150 ppm/°C
Vibration (Single Section)		
Total Resistance Shift.....	±2 % maximum.....	±2 % maximum
Voltage Ratio Shift.....	±5 % maximum.....	±5 % maximum
Shock (Single Section).....	30 G.....	30 G
Total Resistance Shift.....	±2 % maximum.....	±2 % maximum
Voltage Ratio Shift.....	±5 % maximum.....	±5 % maximum
Load Life.....	1,000 hours.....	1,000 hours
Total Resistance Shift.....	±10 % maximum.....	±5 % maximum
Rotational Life (No Load).....	100,000 cycles.....	100,000 cycles
Total Resistance Shift.....	(Linear taper) 10 ohms or ±10 % TRS max. (whichever is greater) (Audio taper) ±20 % maximum	(All tapers) ±5 % TRS maximum
Contact Resistance Variation @ 50,000 cycles		
(Audio taper).....	±3 %.....	±3 %
(Linear taper).....	±2 %.....	±2 %
Moisture Resistance (MIL-STD-202, Method 103, Condition B)		
Total Resistance Shift.....	(B & E tapers) ±10 % maximum.....	±5 % maximum (all tapers)
	(D, G, S & T tapers) ±20 % maximum	
Insulation Resistance (500 VDC).....	100 megohms minimum.....	100 megohms minimum
IP Rating.....	IP 40.....	IP 40

Mechanical Characteristics¹

Stop Strength		
1/4 " and 1/8 " diameter shafts.....		45.19 N-cm (4 lb.-in.)
7/8 " length shaft.....		22.6 N-cm (2 lb.-in.)
Mechanical Angle.....		300 ° ± 5 °
Torque		
Starting and Running Torque (Non-Locking Bushings)		
Single Section.....	0.14 to 1.06 N-cm (0.2 to 1.5 oz.-in.)	
Dual Section.....	0.14 to 1.06 N-cm (0.2 to 1.5 oz.-in.)	
Triple Section.....	0.35 to 1.41 N-cm (0.5 to 2.0 oz.-in.)	
Quadruple Section.....	0.35 to 1.41 N-cm (0.5 to 2.0 oz.-in.)	
Starting and Running Torque (Locking Bushings).....	0.14 to 2.82 N-cm (0.2 to 4.0 oz.-in.)	
Shaft Locking Torque with Locknut @ 10 in.-lb. (B & E Bushings).....	14 N-cm (20 oz.-in.)	
Mounting.....	1.7-2.0 N-m (15-18 lb.-in.) maximum	
Weight (Single Section).....	21 grams maximum	
(Each Additional Section).....	6 grams maximum	
Terminals.....	Printed circuit terminals or J-Hooks	
Soldering Condition.....	Recommended hand soldering using Sn95/Ag5 no clean solder, 0.025 " wire diameter. Maximum temperature 399 °C (750 °F) for 3 seconds. No wash process to be used with no clean flux.	
Marking.....	Manufacturer's trademark, wiring diagram, date code and resistance, manufacturer's part number	
Ganging (multiple section potentiometers).....	4 cup maximum	
Hardware.....	One lockwasher and one mounting nut is shipped with each potentiometer, except where noted in the part number.	

For dimensional drawings see pages 3 & 4.

NOTE: Model 81/82 performance specifications do not apply to units subjected to printed circuit board cleaning procedures.

For ordering information see page 5.

¹At room ambient: +25 °C nominal and 50 % relative humidity nominal, except as noted.

Specifications are subject to change without notice.

Customers should verify actual device performance in their specific applications.

*RoHS Directive 2002/95/EC Jan 27 2003 including Annex

81/82 - 5/8 " Square Single-Turn Panel Control
85/86 - 5/8 " Square Single-Turn Panel Control with Rotary Switch



Rotary Switch Specifications

Initial Electrical Characteristics¹

Contacts:	
DPST	N.O./N.O., N.C./N.C. or N.O./N.C.
DPDT	2 N.O./N.C. (break before make)
Power Rating (Resistive Load):	
DPST	2 A @ 125 volts RMS-60 Hz or 2 A @ 28 VDC, 1 A @ 250 volts RMS-60 Hz
DPDT	1 A @ 125 volts RMS-60 Hz or 1 A @ 28 VDC
Contact Resistance (0.1 VDC-10 mA)	10 milliohms nominal
Contact Bounce	5 milliseconds maximum
Dielectric Withstanding Voltage (MIL-STD-202, Method 301)	
Sea Level	1500 VAC minimum
Insulation Resistance	1000 megohms minimum

Environmental Characteristics¹

Operating Temperature Range	0 °C to +70 °C
Storage Temperature Range	-65 °C to +125 °C
Vibration (Dual Section)	8 G
Contact Resistance	10 milliohms maximum
Contact Bounce	0.1 millisecond maximum
Shock (Dual Section)	20 G
Contact Resistance	10 milliohms maximum
Contact Bounce	0.1 millisecond maximum
Rotational Life	25,000 cycles
Switch Actuating Torque (50% Duty cycle @ Rated Power Load)	1.41 to 4.94 N-cm (2 to 7 oz.-in.)
Contact Resistance	10 milliohms maximum
Moisture Resistance (MIL-STD-202, Method 106, Condition B)	
Contact Resistance (0.1 VDC-10 mA)	10 milliohms maximum
Insulation Resistance (After 24 Hours @ Room Temperature) (500 VDC)	100 megohms minimum
Switch Housing Material	High temperature, flame retardant, thermosetting plastic

Mechanical Characteristics¹

Actuating Torque (Each Section, Switch Module Only)	3.53 to 10.6 N-cm (5 to 15 oz.-in.)
Running Torque (Out of Detent, 2-4 Module Assembly)	0.21 to 1.41 N-cm (0.3 to 2 oz.-in.)
Detent	CW or CCW standard
Actuation Angle	25 °
Contact Materials	Fine silver with gold overlay
Terminal Styles	Solder lug only
Standard Orientation	In-line with control terminals
Optional	Rotated 90 ° CCW from standard
Terminal Strength (Before and After Soldering Heat Exposure)	0.9 Kg (2 lbs.) minimum

NOTE: Model 81/82 performance specifications do not apply to units subjected to printed circuit board cleaning procedures.

¹At room ambient: +25 °C nominal and 50 % relative humidity nominal, except as noted.

81/82 - 5/8 " Square Single-Turn Panel Control

BOURNS®

Product Dimensions

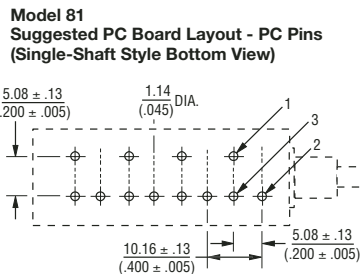
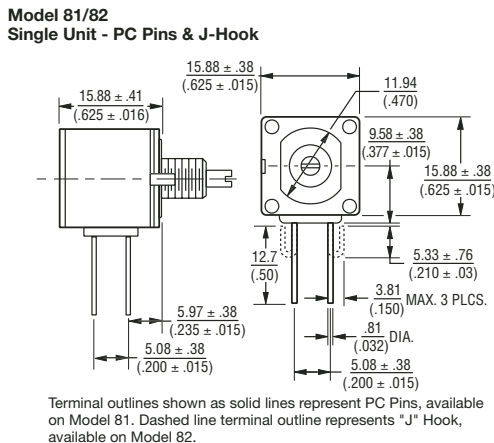
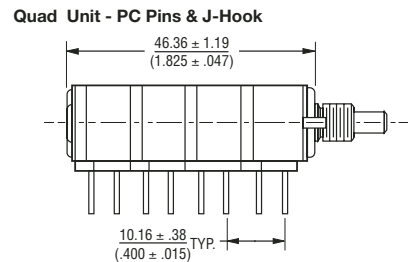
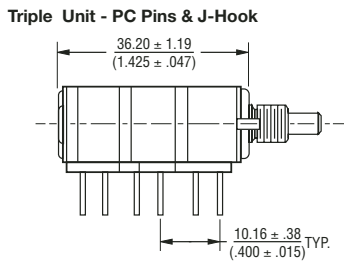
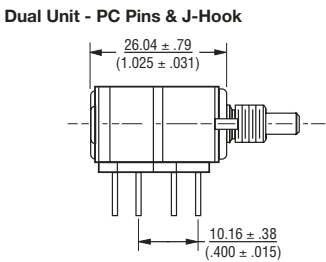
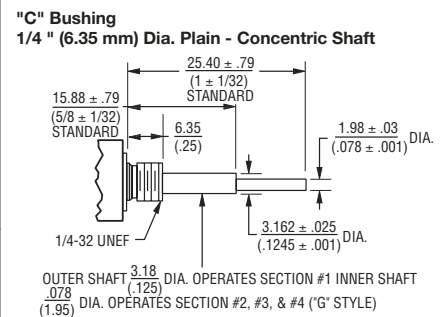
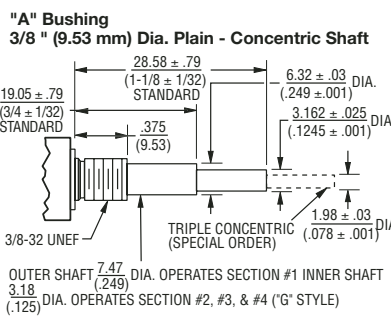
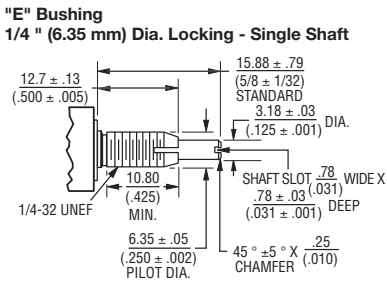
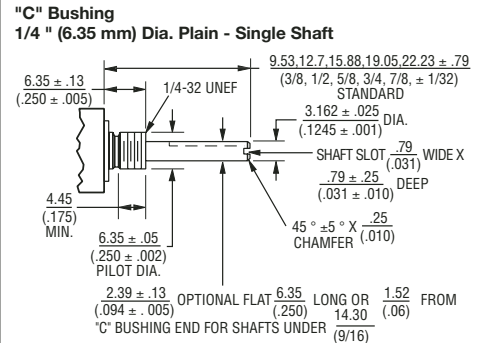
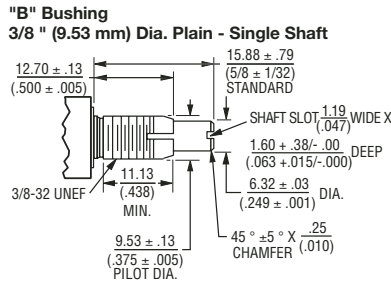
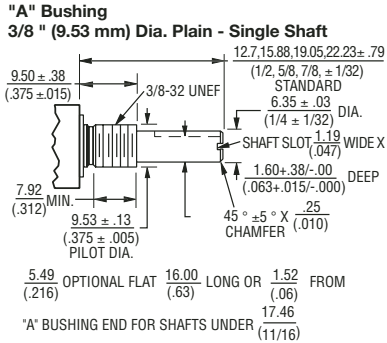

Note: For units with dual concentric shaft styles, a .100 (2.54) spacer is added between the module(s) driven by the outer shaft and those driven by the inner shaft. For G, K, or V shafts, add the spacer between modules 1 and 2. For L or M shafts, add the spacer between modules 2 and 3. For N or P shafts, add the spacer between modules 3 and 4.

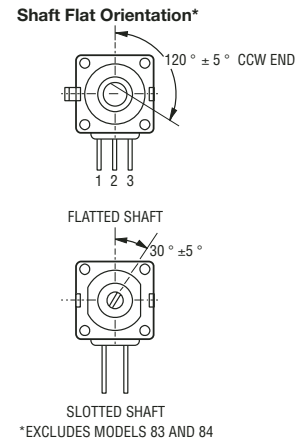

DIMENSIONS ARE: $\frac{\text{MM}}{\text{(INCHES)}}$

Specifications are subject to change without notice. Customers should verify actual device performance in their specific applications.

85/86 - 5/8" Square Single-Turn Panel Control with Rotary Switch

BOURNS®

Product Dimensions

Primary Potentiometer Module Model 85/86

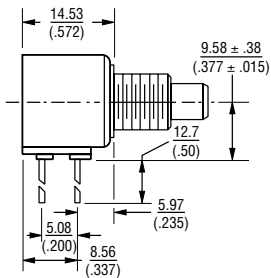

Secondary Potentiometer Module Model 85/86

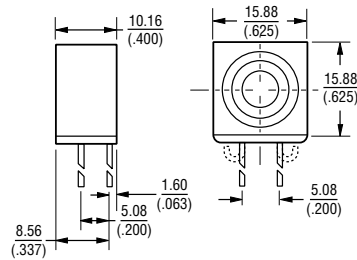

Shaft Flat Orientation*

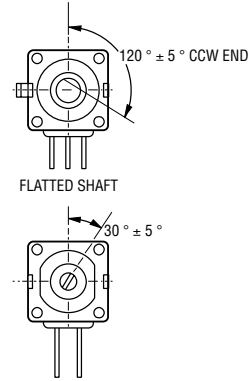

FLATTED SHAFT
SLOTTED SHAFT

*EXCLUDES MODELS 83 AND 84

Switch Module Model 85/86

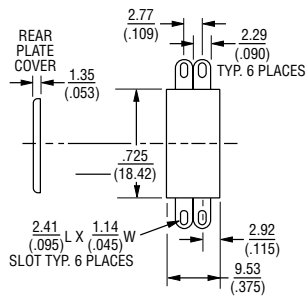

Assembly Sequence Model 85/86 Secondary Potentiometer Module

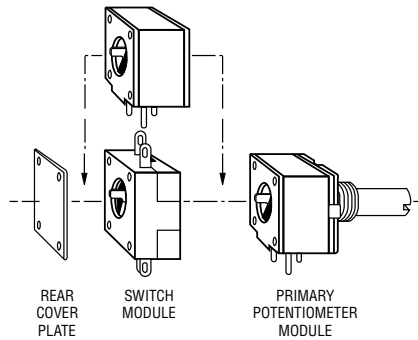

REAR COVER PLATE
SWITCH MODULE
PRIMARY POTENTIOMETER MODULE

TOLERANCES EXCEPT AS SHOWN: DECIMAL .XXX ± $\frac{.127}{.005}$
.XX ± $\frac{.38}{.015}$
ANGLE ± 5 %

Locating Lug Options - All Model 80 Series

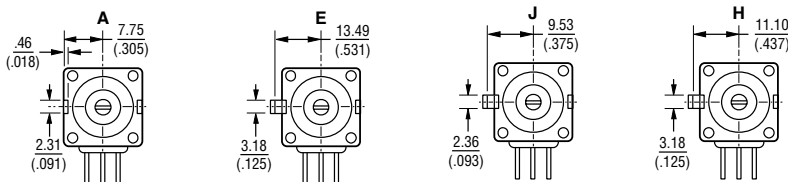

$$E = \frac{2.36 \pm .76}{(.093 \pm .03)} \quad H \text{ \& J } = \frac{1.98 \pm .41}{(.078 \pm .016)}$$

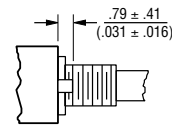

NOTE: "D" OPTION - NO A/R LUG. OTHER LOCATING LUG OPTIONS AVAILABLE. FOR DETAILS CONSULT FACTORY.

DIMENSIONS ARE: $\frac{\text{MM}}{\text{(INCHES)}}$

81/82 - 5/8 " Square Single-Turn Panel Control 85/86 - 5/8 " Square Single-Turn Panel Control with Rotary Switch

BOURNS®

How to Order

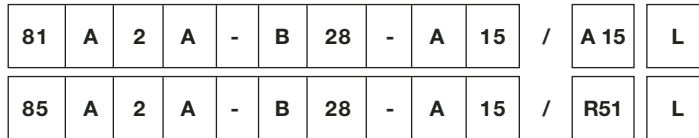

Models 81 & 82: Part number for multiple section potentiometers must have a taper and resistance value for each section.

Models 85 & 86: Part number must contain a switch type.

ANTI-ROTATION LUG	
A	Single .305 R, 90 °CW
B	Double .305 R, 90 ° & 270 °CW
C	Single .305 R, 270 °CW
D	No Lug
E	Single .531 R, 90 °CW
F	Single .305 R, 180 °CW
J	Single .375 R, 90 °CW
K	Double .375 R, 90 ° & 270 °CW

# SECTIONS	APPLICABLE MODELS
1 Single	81,82
2 Double	81,82,85,86
3 Triple	81,82,85,86
4 Quad	81,82,85,86

BUSHING	
A	Plain 3/8 " (9.53 mm) D x 3/8 " (9.65 mm) L
B	Locking 3/8 " (9.65 mm) D x 1/2 " (12.7 mm) L
C	Plain 1/4 " (6.35 mm) D x 1/4 " (6.35 mm) L
E	Locking 1/4 " (6.35 mm) D x 1/2 " (12.7 mm) L
J	Plain 3/8 " (9.65 mm) D x 1/4 " (6.35 mm) L
N	Plain 1/4 " (6.35 mm) D x 3/8 " (9.65 mm) L
R	Plain 10 mm D x 9 mm L
U	Plain 7 mm D x 6 mm L

MODEL	
81	Single-Turn, PC Pins
82	Single-Turn, J-Hooks
85	Single-Turn, Pot/Rotary Switch, PC Pins
86	Single-Turn, Pot/Rotary Switch, J-Hooks

SHAFT LENGTH (FMS)		AVAILABLE ONLY IN BUSHING
Code	Description	Code
12	3/8 "L	C, N, J
16	1/2 "L	A, C, J, N
20	5/8 "L	A, B, C, E, J, N
24	3/4 "L	A, B, C, E, J, N
28	7/8 "L	A, B, C, E, J, N
32	1 "L	A, B, C, E, J, N
36	1-1/8 "L	A, B, C, E, J, N
40	1-1/4 "L	A, B, C, E, J, N
METRIC		
10	10 mmL	U
13	13 mmL	U
16	16 mmL	R
19	19 mmL	R
22	22 mmL	R, U
30	30 mmL	R
42	42 mmL	R
50	50 mmL	R

POTENTIOMETER TYPE	
L	RoHS Compliant
Blank	Standard

SWITCH TYPE (MODELS 85 & 86 ONLY)	
(R50)	DPST N.O./N.C. CW Detent In-Line Term
(R51)	DPST N.O./N.C. CCW Detent In-Line Term
(R52)	DPST N.O./N.O. CW Detent In-Line Term
(R53)	DPST N.O./N.O. CCW Detent In-Line Term
(R54)	DPST N.C./N.C. CW Detent In-Line Term
(R55)	DPST N.C./N.C. CCW Detent In-Line Term
(R56)	DPST N.O./N.C. CW Detent Horz Term
(R57)	DPST N.O./N.C. CCW Detent Horz Term
(R58)	DPST N.O./N.O. CW Detent Horz Term
(R59)	DPST N.O./N.O. CCW Detent Horz Term
(R60)	DPST N.C./N.C. CW Detent Horz Term
(R61)	DPST N.C./N.C. CCW Detent Horz Term
(R70)	DPDT CW Detent In-Line Term
(R71)	DPDT CCW Detent In-Line Term
(R72)	DPDT CW Detent Horz Term
(R73)	DPDT CCW Detent Horz Term

SHAFT TYPE	AVAILABLE ONLY IN	
	LENGTHS (CODE)	BUSHINGS (CODE)
A Single Plain 1/4 " (6.35 mm) D	16,20,24,28	A, B, J
B Single Slotted 1/4 " (6.35 mm) D	16,20,24,28	A, B, J
C Single Flatted 1/4 " (6.35 mm) D	20,24,28	A, B, J
E Single Slotted 1/8 " (3.18 mm) D	12,16,20,24,28	C, E, N
F Single Flatted 1/8 " (3.18 mm) D	Consult Factory	C, N
G Dual Concentric Plain 1/4 " (6.35 mm) D - 1/8 " (3.18 mm) D Outer Operates Section 1	36,40	A, J
K Dual Concentric Plain 1/8 " (3.18 mm) D - 5/64 " (1.98 mm) D Outer Operates Section 1	32,36	C, N
L Dual Concentric Plain 1/4 " (6.35 mm) D - 1/8 " (3.18 mm) D Outer Operates Section 1/2	36,40	A, J
M Dual Concentric Plain 1/8 " (3.18 mm) D - 5/64 " (1.98 mm) D Outer Operates Section 1	32,36	C, N
N Dual Concentric Plain 1/4 " (6.35 mm) D - 1/8 " (3.18 mm) D Outer Operates Section 1/2/3	36,40	A, J
P Dual Concentric Plain 1/8 " (3.18 mm) D - 5/64 " (1.98 mm) D Outer Operates Section 1/2	32,36	C, N
R Single Slotted 6 mm D	16,19,22,50	R
T Single Slotted 4 mm D	10, 13, 22	U
V Dual Concentric Plain 6 mm D - 3 mm D Outer Operates Section 1	30, 42	R

ELEMENT TYPE TAPER/TOLERANCE	RESISTANCE CODE VALUE IN OHMS	
(A) Linear Cermet ±10 %	(05) - 100	(30) - 15 K
(H) Linear Cermet ±5 %	(28) - 150	(16) - 20 K
	(06) - 200	(17) - 25 K
	(07) - 250	(18) - 50 K
	(08) - 500	(19) - 75 K
	(09) - 750	(20) - 100 K
	(10) - 1 K	(31) - 150 K
	(29) - 1.5 K	(21) - 200 K
	(11) - 2 K	(22) - 250 K
	(12) - 2.5 K	(23) - 500 K
	(13) - 5 K	(24) - 750 K
	(14) - 7.5 K	(25) - 1 M
	(15) - 10 K	
(B) Linear C-P ±20 %	(10) - 1 K	(18) - 50 K
(E) Linear C-P ±10 %	(12) - 2.5 K	(20) - 100 K
	(13) - 5 K	(22) - 250 K
	(15) - 10 K	(23) - 500 K
	(16) - 20 K	(25) - 1 M
	(17) - 25 K	
(C) CW Audio Cermet ±10 %	(10) - 1 K	(18) - 50 K
(D) CW Audio C-P ±20 %	(12) - 2.5 K	(20) - 100 K
(F) CCW Audio Cermet ±10 %	(13) - 5 K	(22) - 250 K
(G) CCW Audio C-P ±20 %	(15) - 10 K	(23) - 500 K
(S) CW Audio C-P ±10 %	(17) - 25 K	(25) - 1 M
(T) CCW Audio C-P ±10 %	(18) - 50 K	

Boldface features are Bourns standard options. All others are available with higher minimum order quantities.