



DAC7734

For most current data sheet and other product information, visit www.burr-brown.com

16-Bit, Quad Voltage Output, Serial Input DIGITAL-TO-ANALOG CONVERTER

FEATURES

- **LOW POWER: 200mW**
- **UNIPOLAR OR BIPOLAR OPERATION**
- **SINGLE SUPPLY OUTPUT RANGE: +10V**
- **DUAL SUPPLY OUTPUT RANGE: $\pm 10V$**
- **SETTLING TIME: 10 μ s to 0.003%**
- **16-BIT MONOTONICITY: $-40^{\circ}C$ to $+85^{\circ}C$**
- **PROGRAMMABLE RESET TO MID-SCALE OR ZERO-SCALE**
- **DOUBLE-BUFFERED DATA INPUTS**
- **± 1 LSB DNL: $-40^{\circ}C$ to $+85^{\circ}C$**

APPLICATIONS

- **PROCESS CONTROL**
- **ATE PIN ELECTRONICS**
- **CLOSED-LOOP SERVO-CONTROL**
- **MOTOR CONTROL**
- **DATA ACQUISITION SYSTEMS**
- **DAC-PER-PIN PROGRAMMERS**

DESCRIPTION

The DAC7734 is a 16-bit, quad voltage output, digital-to-analog converter with guaranteed 16-bit monotonic performance over the specified temperature range. It accepts 24-bit serial input data, has double-buffered DAC input logic (allowing simultaneous update of all DACs), and provides a serial data output for daisy chaining multiple DACs. Programmable asynchronous reset clears all registers to a mid-scale code of 8000_H or to a zero-scale of 0000_H. The DAC7734 can operate from a single +15V supply or from +15V and -15V, and +5V supplies.

Low power and small size per DAC make the DAC7734 ideal for automatic test equipment, DAC-per-pin programmers, data acquisition systems, and closed-loop servo-control. The DAC7734 is available in a 48-lead SSOP package and offers guaranteed specifications over the $-40^{\circ}C$ to $+85^{\circ}C$ temperature range.

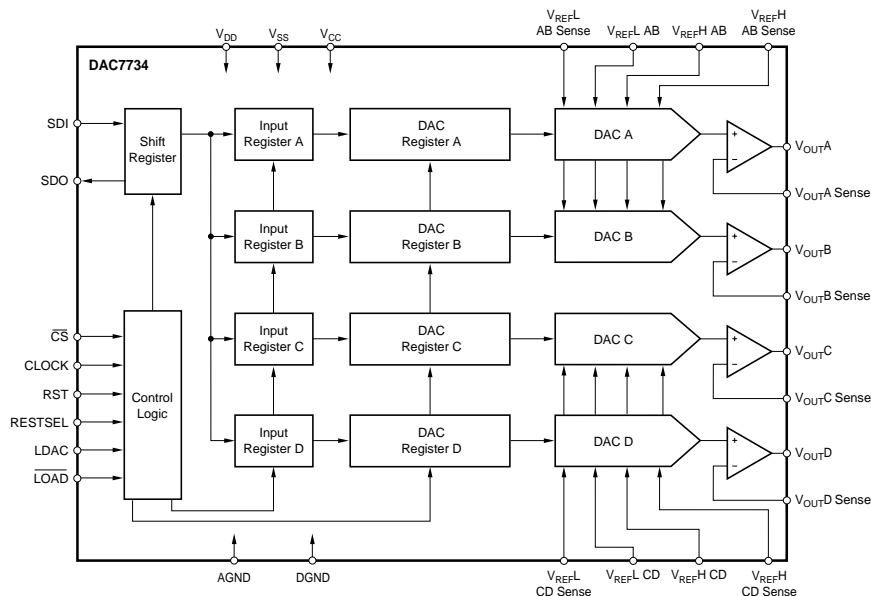

International Airport Industrial Park • Mailing Address: PO Box 11400, Tucson, AZ 85734 • Street Address: 6730 S. Tucson Blvd., Tucson, AZ 85706 • Tel: (520) 746-1111
 Twx: 910-952-1111 • Internet: <http://www.burr-brown.com/> • Cable: BBRCORP • Telex: 066-6491 • FAX: (520) 889-1510 • Immediate Product Info: (800) 548-6132

SPECIFICATIONS (Dual Supply)

At $T_A = T_{MIN}$ to T_{MAX} , $V_{CC} = +15V$, $V_{DD} = +5V$, $V_{SS} = -15V$, $V_{REFH} = +10V$, and $V_{REFL} = -10V$, unless otherwise noted.

PARAMETER	CONDITIONS	DAC7734E			DAC7734EB			DAC7734EC			UNITS
		MIN	TYP	MAX	MIN	TYP	MAX	MIN	TYP	MAX	
ACCURACY											
Linearity Error (INL) T_{MIN} to T_{MAX}	$T = 25^{\circ}C$			± 3 ± 4			*			± 2 ± 3	LSB LSB
Linearity Match			± 4			*			± 2		LSB
Differential Linearity Error (DNL) T_{MIN} to T_{MAX}	$T = 25^{\circ}C$			± 3 ± 3			± 2 ± 2			± 1 ± 1	LSB LSB
Monotonicity, T_{MIN} to T_{MAX}		14			15			16			Bits
Bipolar Zero Error	$T = 25^{\circ}C$		± 0.01	± 0.025			*			*	% of FSR
Bipolar Zero Error, T_{MIN} to T_{MAX}				± 0.05			*			*	% of FSR
Full-Scale Error	$T = 25^{\circ}C$			± 0.025			*			*	% of FSR
Full-Scale Error, T_{MIN} to T_{MAX}				± 0.05			*			*	% of FSR
Bipolar Zero Matching	Channel-to-Channel Matching			± 0.024			*			*	% of FSR
Full-Scale Matching	Channel-to-Channel Matching			± 0.024			*			*	% of FSR
Power Supply Rejection Ratio (PSRR)	At Full Scale			25			*			*	ppm/V
ANALOG OUTPUT											
Voltage Output		V_{REFL}		V_{REFH}	*		*	*		*	V
Output Current		± 5			*			*		*	mA
Maximum Load Capacitance			500			*		*		*	pF
Short-Circuit Current			± 20			*		*		*	mA
Short-Circuit Duration	To V_{SS} , V_{CC} or GND		Indefinite			*		*		*	
REFERENCE INPUT											
Ref High Input Voltage Range		$V_{REFL} + 1.25$		+10	*		*	*		*	V
Ref Low Input Voltage Range		-10		$V_{REFH} - 1.25$	*		*	*		*	V
Ref High Input Current		-0.3		2.6		*		*		*	mA
Ref Low Input Current		-3.2		-0.3		*		*		*	mA
DYNAMIC PERFORMANCE											
Settling Time	To $\pm 0.003\%$, 20V Output Step See Figure 5		9	11		*	*		*	*	μs
Channel-to-Channel Crosstalk			0.5			*		*		*	LSB
Digital Feedthrough			2			*		*		*	nV-s
Output Noise Voltage	$f = 10kHz$		60			*		*		*	nV/\sqrt{Hz}
DIGITAL INPUT											
V_{IH}		$0.7 \cdot V_{DD}$		V_{DD}	*			*		*	V
V_{IL}		0		$0.3 \cdot V_{DD}$			*			*	V
I_{IH}				± 10			*			*	μA
I_{IL}				± 10			*			*	μA
DIGITAL OUTPUT											
V_{OH}	$I_{OH} = -0.8mA$	3.6	4.5		*	*		*	*	*	V
V_{OL}	$I_{OL} = 1.6mA$		0.3	0.4		*	*		*	*	V
POWER SUPPLY											
V_{DD}		+4.75	+5.0	+5.25	*	*	*	*	*	*	V
V_{CC}		+14.25	+15.0	+15.75	*	*	*	*	*	*	V
V_{SS}		-14.25	-15.0	-15.75	*	*	*	*	*	*	V
I_{DD}			50			*		*		*	μA
I_{CC}			6			*		*		*	mA
I_{SS}			-5			*		*		*	mA
Power			170	200		*		*		*	mW
TEMPERATURE RANGE											
Specified Performance		-40		+85	*		*	*		*	$^{\circ}C$

* Specifications same as grade to the left.

The information provided herein is believed to be reliable; however, BURR-BROWN assumes no responsibility for inaccuracies or omissions. BURR-BROWN assumes no responsibility for the use of this information, and all use of such information shall be entirely at the user's own risk. Prices and specifications are subject to change without notice. No patent rights or licenses to any of the circuits described herein are implied or granted to any third party. BURR-BROWN does not authorize or warrant any BURR-BROWN product for use in life support devices and/or systems.

SPECIFICATIONS (Single Supply)

At $T_A = T_{MIN}$ to T_{MAX} , $V_{CC} = +15V$, $V_{DD} = +5V$, $V_{SS} = GND$, $V_{REFH} = +10V$, and $V_{REFL} = +50mV$, unless otherwise noted.

PARAMETER	CONDITIONS	DAC7734E			DAC7734EB			DAC7734EC			UNITS
		MIN	TYP	MAX	MIN	TYP	MAX	MIN	TYP	MAX	
ACCURACY											
Linearity Error ⁽¹⁾ (INL) T_{MIN} to T_{MAX}	$T = 25^{\circ}C$			± 3 ± 4			*			± 2 ± 3	LSB LSB
Linearity Match			± 4			*			± 2		LSB
Differential Linearity Error (DNL) T_{MIN} to T_{MAX}	$T = 25^{\circ}C$			± 3 ± 3					± 2 ± 2		LSB LSB
Monotonicity, T_{MIN} to T_{MAX}	$T = 25^{\circ}C$	14	± 0.01	± 0.025	15			16		*	Bits
Unipolar Zero	$T = 25^{\circ}C$			± 0.05			*			*	% of FSR
Unipolar Zero Error, T_{MIN} to T_{MAX}	$T = 25^{\circ}C$			± 0.025			*			*	% of FSR
Full-Scale Error	$T = 25^{\circ}C$			± 0.05			*			*	% of FSR
Full-Scale Error, T_{MIN} to T_{MAX}				± 0.024			*			*	% of FSR
Unipolar Zero Matching	Channel-to-Channel Matching						*			*	% of FSR
Full-Scale Matching	Channel-to-Channel Matching			± 0.024			*			*	% of FSR
Power Supply Rejection Ratio (PSRR)	At Full Scale			25			*			*	ppm/V
ANALOG OUTPUT											
Voltage Output	$V_{REFL} = 0V$, $V_{SS} = 0V$ $R = 10k\Omega$	0		V_{REFH}	*		*	*		*	V
Output Current		± 5			*			*		*	mA
Maximum Load Capacitance			500			*		*	*	*	pF
Short-Circuit Current			± 20			*		*	*	*	mA
Short-Circuit Duration	To V_{CC} or GND		Indefinite			*		*	*	*	
REFERENCE INPUT											
Ref High Input Voltage Range		$V_{REFL} + 1.25$		+10	*		*	*		*	V
Ref Low Input Voltage Range		0		$V_{REFH} - 1.25$	*		*	*		*	V
Ref High Input Current		-0.3		1.0		*			*	*	mA
Ref Low Input Current		-1.5		-0.3		*			*	*	mA
DYNAMIC PERFORMANCE											
Settling Time	To $\pm 0.003\%$, 10V Output Step See Figure 6		8	10		*	*		*	*	μs
Channel-to-Channel Crosstalk			0.5			*			*	*	LSB
Digital Feedthrough			2			*			*	*	nV-s
Output Noise Voltage	$f = 10kHz$		60			*			*	*	nV/\sqrt{Hz}
DIGITAL INPUT											
V_{IH}		$0.7 \cdot V_{DD}$		V_{DD}	*			*		*	V
V_{IL}		0		$0.3 \cdot V_{DD}$			*		*	*	V
I_{IH}				± 10			*		*	*	μA
I_{IL}				± 10			*		*	*	μA
DIGITAL OUTPUT											
V_{OH}	$I_{OH} = -0.8mA$	3.6	4.5		*	*	*	*	*	*	V
V_{OL}	$I_{OL} = 1.6mA$		0.3	0.4		*	*	*	*	*	V
POWER SUPPLY											
V_{DD}		+4.75	+5.0	+5.25	*	*	*	*	*	*	V
V_{CC}		+14.25	+15.0	+15.75	*	*	*	*	*	*	V
V_{SS}			0			*	*	*	*	*	V
I_{DD}			50			*	*	*	*	*	μA
I_{CC}			3.5			*	*	*	*	*	mA
Power			50	70		*	*	*	*	*	mW
TEMPERATURE RANGE											
Specified Performance		-40		+85	*		*	*		*	$^{\circ}C$

* Specifications same as grade to the left.

NOTE: (1) If $V_{SS} = 0V$, the specification applies at code 0021_H and above, due to possible negative zero scale error.

ABSOLUTE MAXIMUM RATINGS⁽¹⁾

V_{CC} to V_{SS}	-0.3V to +32V
V_{CC} to AGND	-0.3V to +16V
V_{SS} to AGND	+0.3V to -16V
AGND to DGND	-0.3V to +0.3V
V_{REFH} to AGND	-9V to +11V
V_{REFL} to AGND	-11V to +9V
V_{DD} to GND	-0.3V to +6V
V_{REFH} to V_{REFL}	-1V to 22V
Digital Input Voltage to GND	-0.3V to $V_{DD} + 0.3V$
Digital Output Voltage to GND	-0.3V to $V_{DD} + 0.3V$
Maximum Junction Temperature	+150°C
Operating Temperature Range	-40°C to +85°C
Storage Temperature Range	-65°C to +150°C
Lead Temperature (soldering, 10s)	+300°C

NOTE: (1) Stresses above those listed under "Absolute Maximum Ratings" may cause permanent damage to the device. Exposure to absolute maximum conditions for extended periods may affect device reliability.



ELECTROSTATIC DISCHARGE SENSITIVITY

This integrated circuit can be damaged by ESD. Burr-Brown recommends that all integrated circuits be handled with appropriate precautions. Failure to observe proper handling and installation procedures can cause damage.

ESD damage can range from subtle performance degradation to complete device failure. Precision integrated circuits may be more susceptible to damage because very small parametric changes could cause the device not to meet its published specifications.

PACKAGE/ORDERING INFORMATION

PRODUCT	LINEARITY ERROR (LSB)	DIFFERENTIAL NONLINEARITY (LSB)	PACKAGE	PACKAGE DRAWING NUMBER	SPECIFICATION TEMPERATURE RANGE	ORDERING NUMBER ⁽¹⁾	TRANSPORT MEDIA
DAC7734E "	±4 "	±3 "	SSOP-48	333 "	-40°C to +85°C "	DAC7734E DAC7734E/1K	Rails Tape and Reel
DAC7734EB "	±4 "	±2 "	SSOP-48 "	333 "	-40°C to +85°C "	DAC7734EB DAC7734EB/1K	Rails Tape and Reel
DAC7734EC "	±3 "	±1 "	SSOP-48 "	333 "	-40°C to +85°C "	DAC7734EC DAC7734EC/1K	Rails Tape and Reel

NOTE: (1) Models with a slash (/) are available only in Tape and Reel in the quantities indicated (e.g., /1K indicates 1000 devices per reel). Ordering 1000 pieces of "DAC7734E/1K" will get a single 1000-piece Tape and Reel.

ESD PROTECTION CIRCUITS

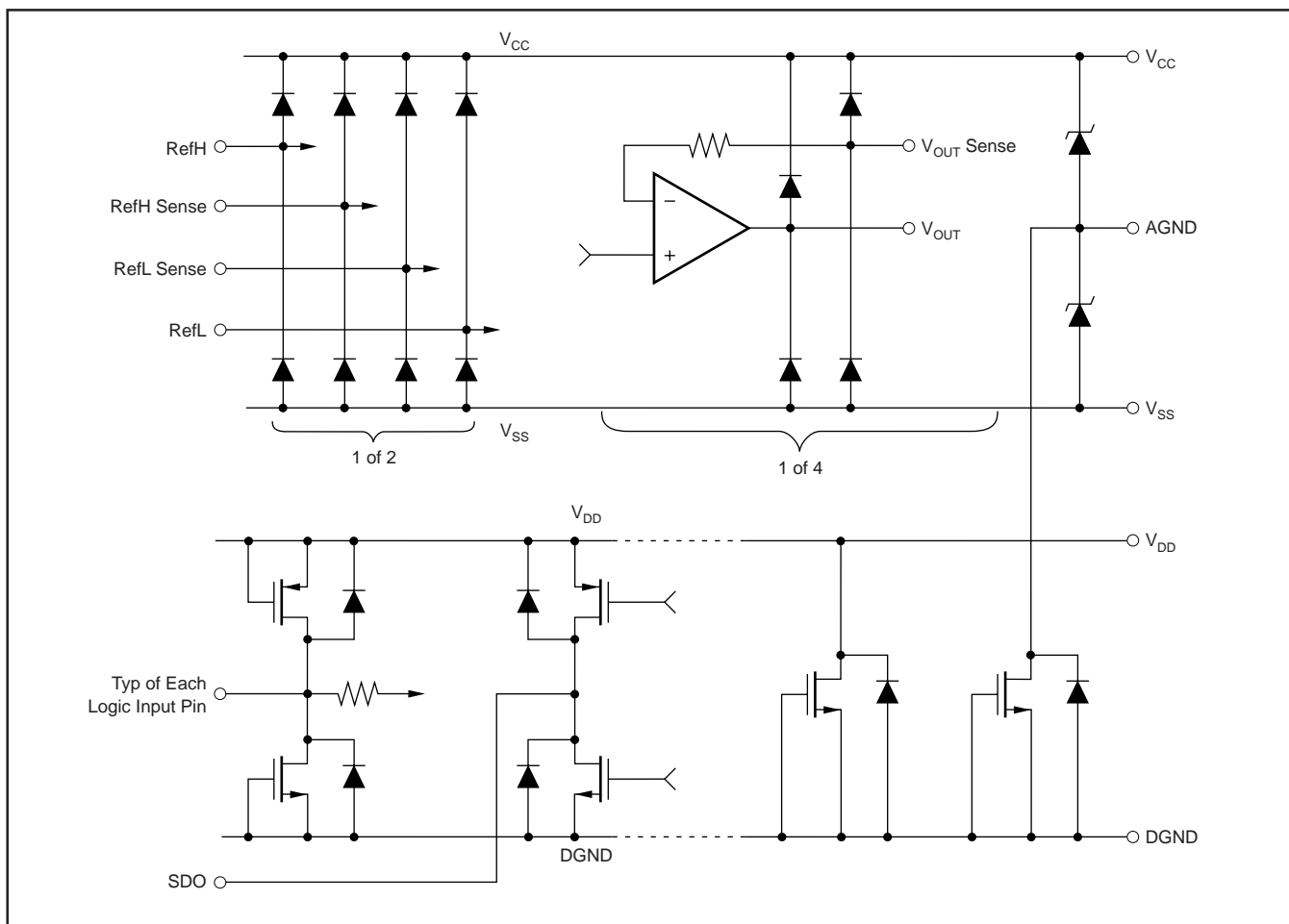

PIN CONFIGURATION

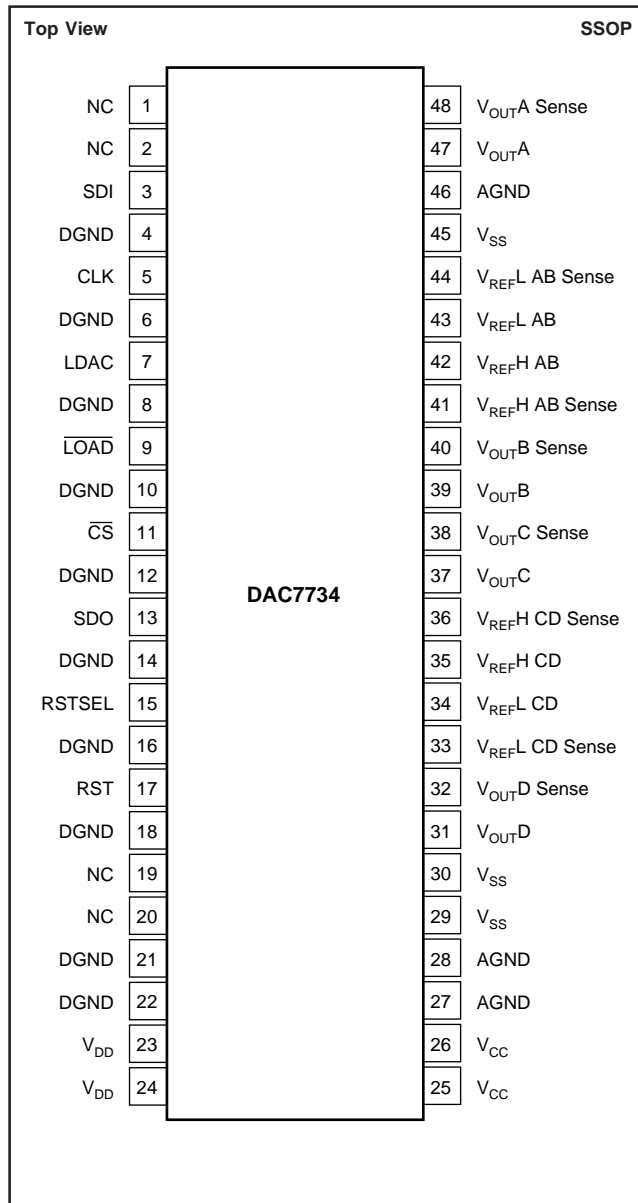

PIN DESCRIPTIONS

PIN	NAME	DESCRIPTION
1	NC	No Connection
2	NC	No Connection
3	SDI	Serial Data Input
4	DGND	Digital Ground
5	CLK	Data Clock Input
6	DGND	Digital Ground
7	LDAC	DAC Register Load Control, Rising Edge Triggered
8	DGND	Digital Ground
9	LOAD	DAC Input Register Load Control, Active Low
10	DGND	Digital Ground
11	CS	Chip Select, Active Low
12	DGND	Digital Ground
13	SDO	Serial Data Output
14	DGND	Digital Ground
15	RSTSEL	Reset Select. Determines the action of RST. If HIGH, a RST common will set the DAC registers to mid-scale (8000H). If LOW, a RST command will set the DAC registers to zero (0000H).
16	DGND	Digital Ground
17	RST	Reset, Rising Edge Triggered. Depending on the state of RSTSEL, the DAC registers are set to either mid-scale or zero.
18	DGND	Digital Ground
19	NC	No Connection
20	NC	No Connection
21	DGND	Digital Ground
22	DGND	Digital Ground
23	V _{DD}	Digital +5V Power Supply
24	V _{DD}	Digital +5V Power Supply
25	V _{CC}	Analog +15V Power Supply
26	V _{CC}	Analog +15V Power Supply
27	AGND	Analog Ground
28	AGND	Analog Ground
29	V _{SS}	Analog -15V Power Supply or 0V Single Supply
30	V _{SS}	Analog -15V Power Supply or 0V Single Supply
31	V _{OUTD}	DAC D Output Voltage
32	V _{OUTD} Sense	DAC D's Output Amplifier Inverting Input. Used to close feedback loop at load.
33	V _{REFL} CD Sense	DAC C and D Reference Low Sense Input
34	V _{REFL} CD	DAC C and D Reference Low Input
35	V _{REFH} CD	DAC C and D Reference High Input
36	V _{REFH} CD Sense	DAC C and D Reference High Sense Input
37	V _{OUTC}	DAC C Output Voltage
38	V _{OUTC} Sense	DAC C's Output Amplifier Inverting Input. Used to close the feedback loop at the load.
39	V _{OUTB}	DAC B Output Voltage
40	V _{OUTB} Sense	DAC B's Output Amplifier Inverting Input. Used to close the feedback loop at the load.
41	V _{REFH} AB Sense	DAC A and B Reference High Sense Input
42	V _{REFH} AB	DAC A and B Reference High Input
43	V _{OUTL} AB	DAC A and B Reference Low Input
44	V _{REFL} AB Sense	DAC A and B Reference Low Sense Input
45	V _{SS}	Analog -15V Power Supply or 0V Single Supply
46	AGND	Analog Ground
47	V _{OUTA}	DAC A Output Voltage
48	V _{OUTA} Sense	DAC A's Output Amplifier Inverting Input. Used to close the feedback loop at the load.

TYPICAL PERFORMANCE CURVES: $V_{SS} = 0V$

At $T_A = +25^\circ C$, $V_{DD} = +5V$, $V_{CC} = +15V$, $V_{SS} = 0$, $V_{REFH} = +10V$, and $V_{REFL} = 0V$, representative unit, unless otherwise specified.

+25°C

LINEARITY ERROR AND
DIFFERENTIAL LINEARITY ERROR vs CODE
(DAC A, +25°C)

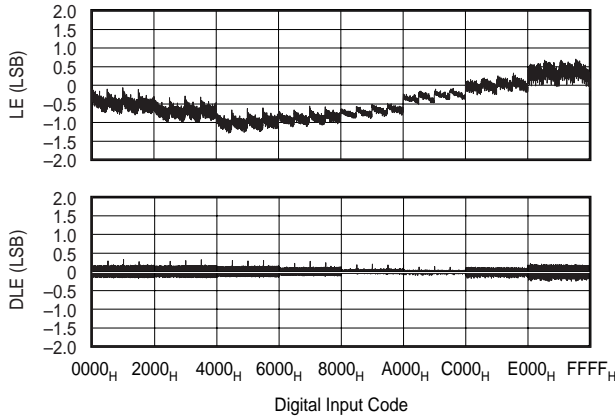

LINEARITY ERROR AND
DIFFERENTIAL LINEARITY ERROR vs CODE
(DAC B, +25°C)

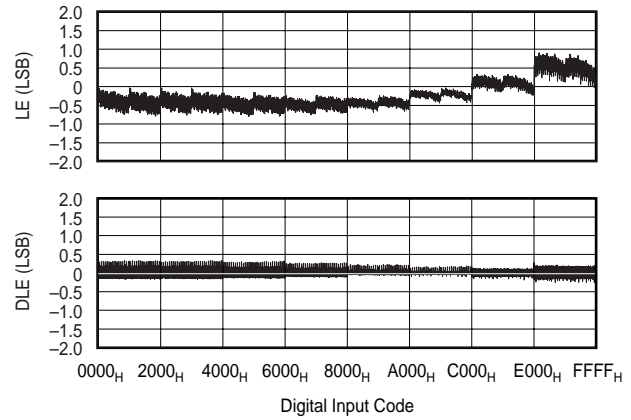

LINEARITY ERROR AND
DIFFERENTIAL LINEARITY ERROR vs CODE
(DAC C, +25°C)

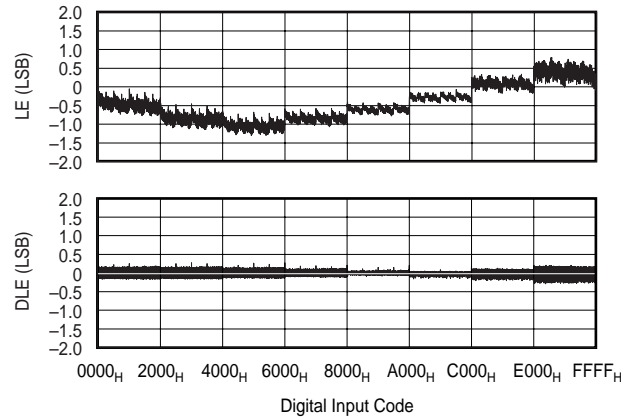

LINEARITY ERROR AND
DIFFERENTIAL LINEARITY ERROR vs CODE
(DAC D, +25°C)

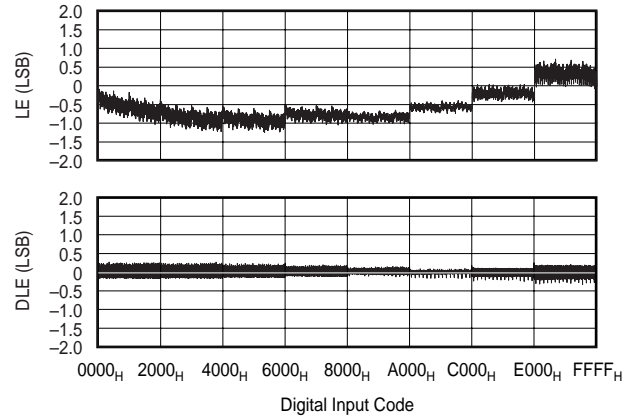

+85°C

LINEARITY ERROR AND
DIFFERENTIAL LINEARITY ERROR vs CODE
(DAC A, +85°C)

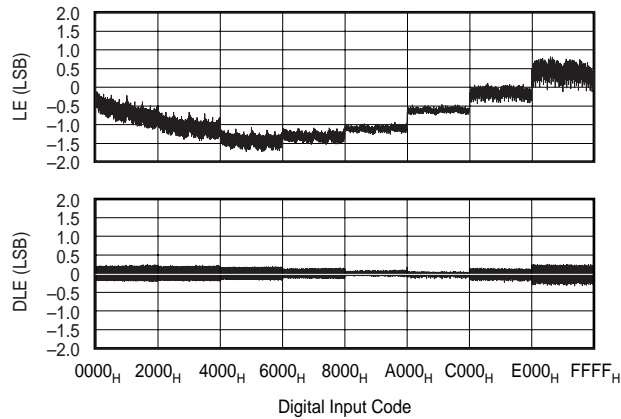

LINEARITY ERROR AND
DIFFERENTIAL LINEARITY ERROR vs CODE
(DAC B, +85°C)

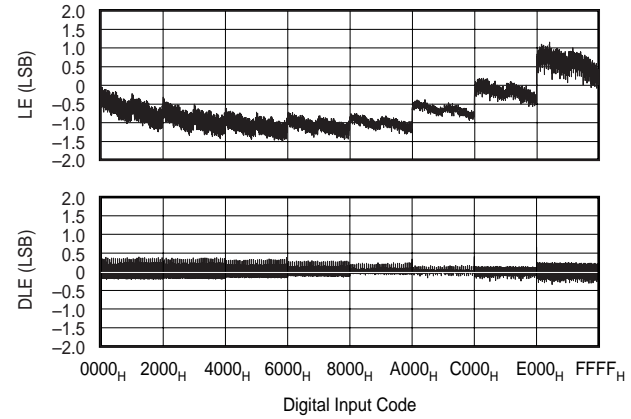

TYPICAL PERFORMANCE CURVES: $V_{SS} = 0V$ (Cont.)

At $T_A = +25^\circ C$, $V_{DD} = +5V$, $V_{CC} = +15V$, $V_{SS} = 0$, $V_{REFH} = +10V$, and $V_{REFL} = 0V$, representative unit, unless otherwise specified.

+85°C (cont.)

LINEARITY ERROR AND DIFFERENTIAL LINEARITY ERROR vs CODE (DAC C, +85°C)

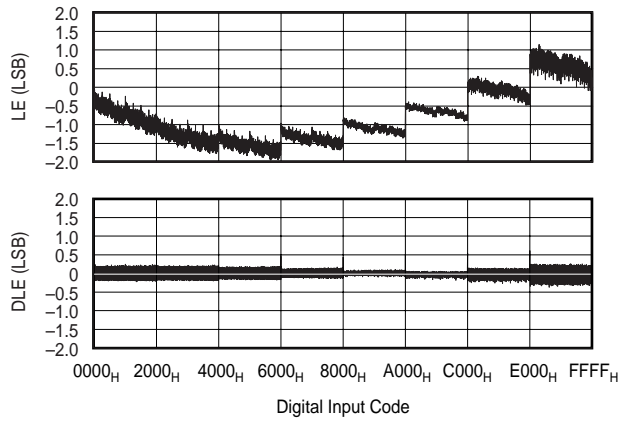

LINEARITY ERROR AND DIFFERENTIAL LINEARITY ERROR vs CODE (DAC D, +85°C)

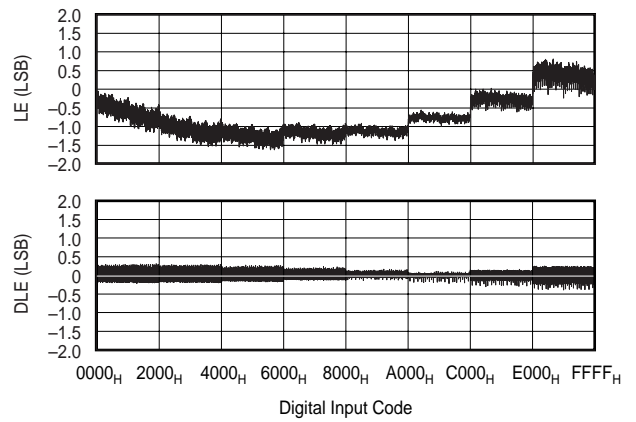

-40°C

LINEARITY ERROR AND DIFFERENTIAL LINEARITY ERROR vs CODE (DAC A, -40°C)

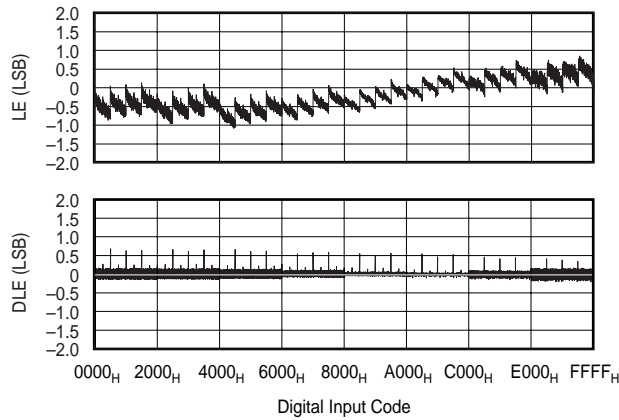

LINEARITY ERROR AND DIFFERENTIAL LINEARITY ERROR vs CODE (DAC B, -40°C)

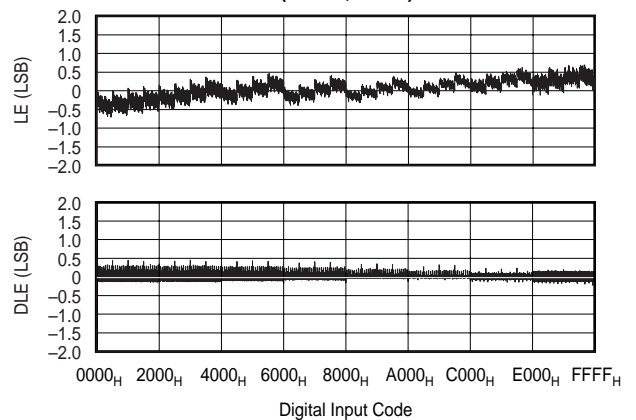

LINEARITY ERROR AND DIFFERENTIAL LINEARITY ERROR vs CODE (DAC C, -40°C)

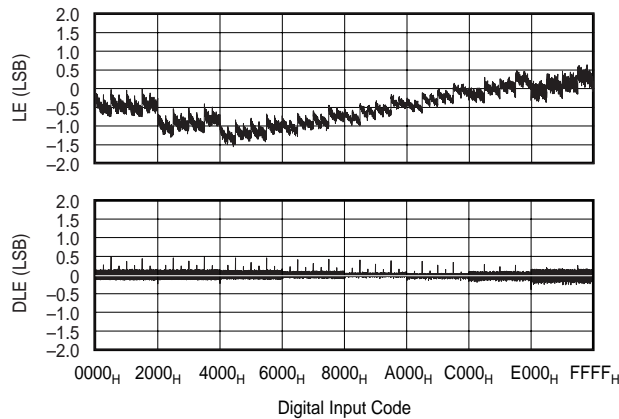

LINEARITY ERROR AND DIFFERENTIAL LINEARITY ERROR vs CODE (DAC D, -40°C)

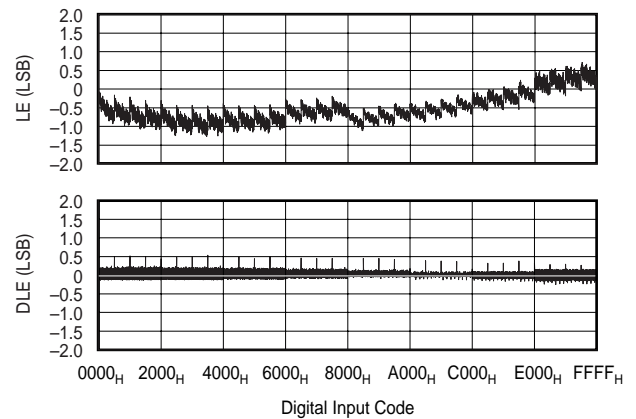

TYPICAL PERFORMANCE CURVES: $V_{SS} = 0V$ (Cont.)

At $T_A = +25^\circ C$, $V_{DD} = +5V$, $V_{CC} = +15V$, $V_{SS} = 0$, $V_{REFH} = +10V$, and $V_{REFL} = 0V$, representative unit, unless otherwise specified.

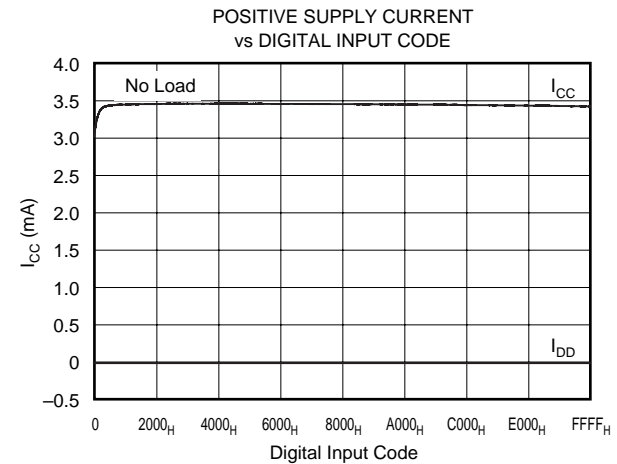
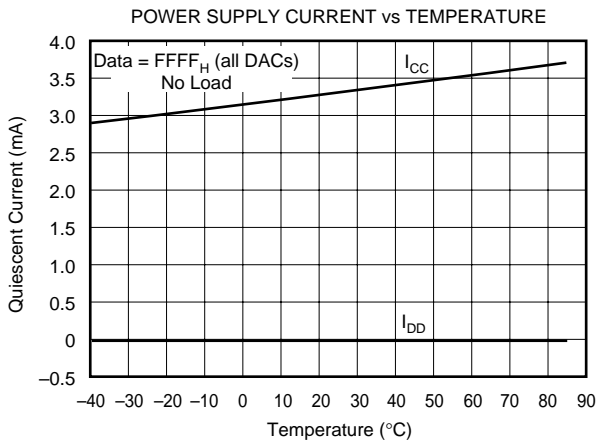
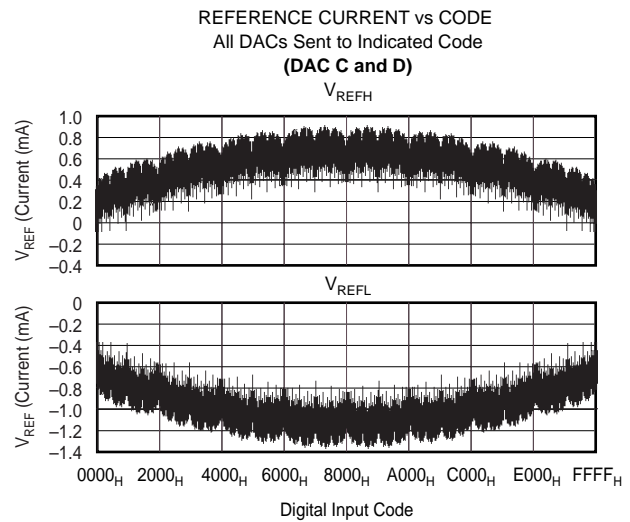
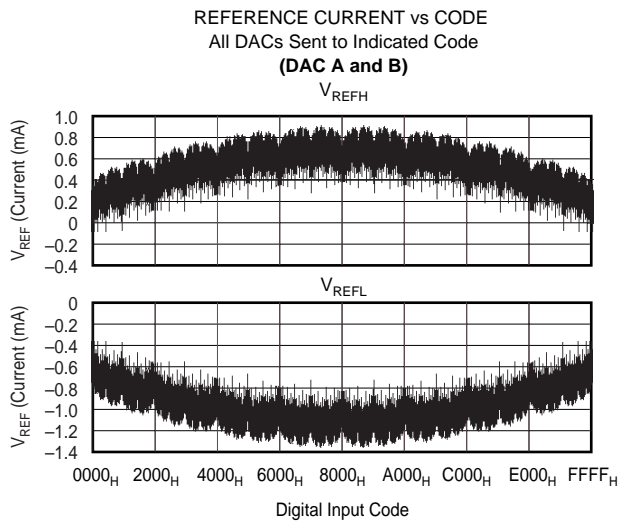
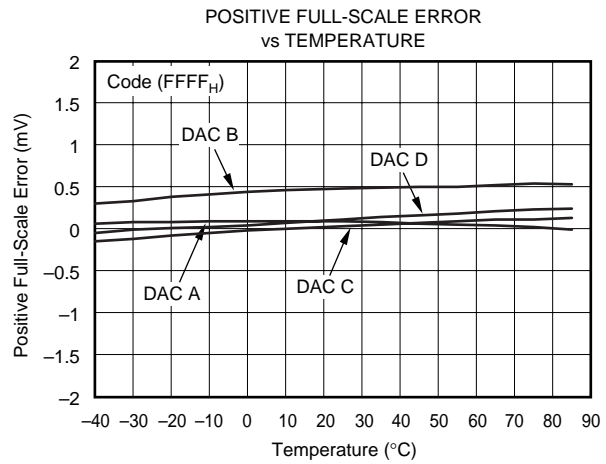
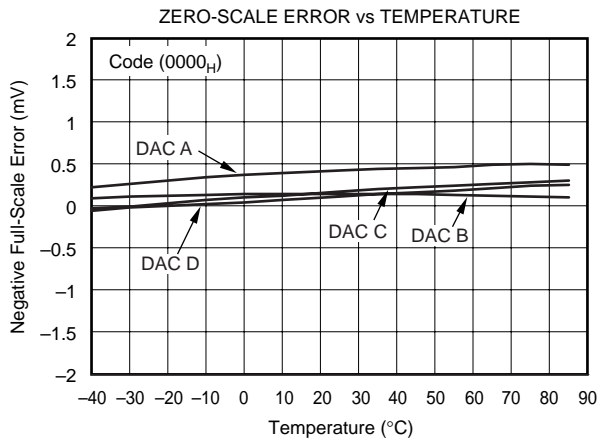

TYPICAL PERFORMANCE CURVES: $V_{SS} = 0V$ (Cont.)

At $T_A = +25^\circ C$, $V_{DD} = +5V$, $V_{CC} = +15V$, $V_{SS} = 0$, $V_{REFH} = +10V$, and $V_{REFL} = 0V$, representative unit, unless otherwise specified.

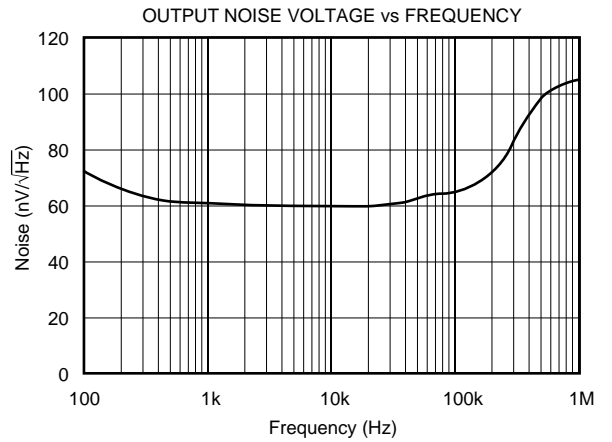
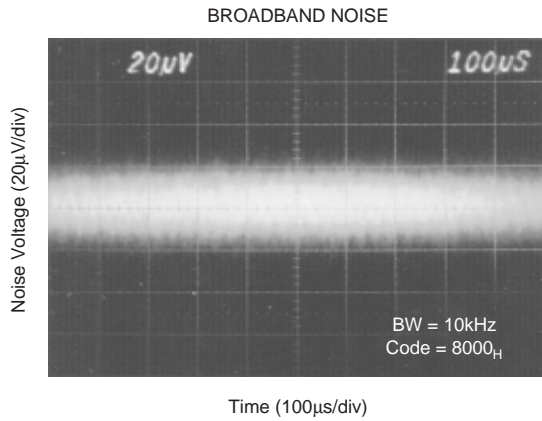
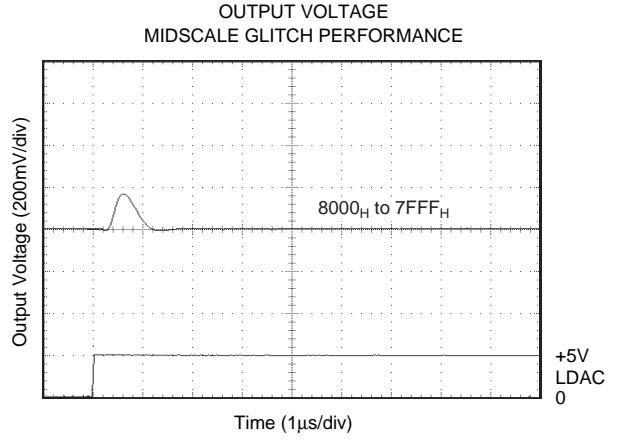
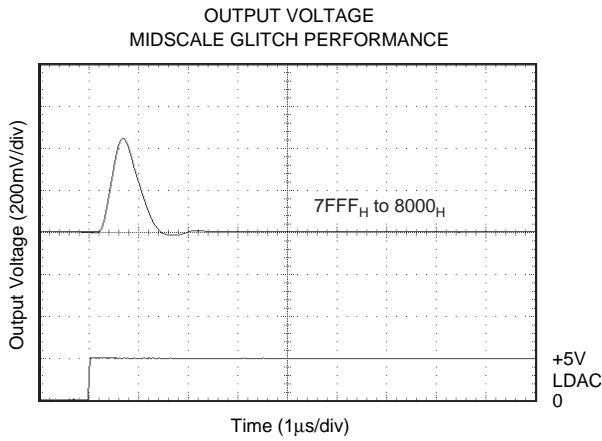
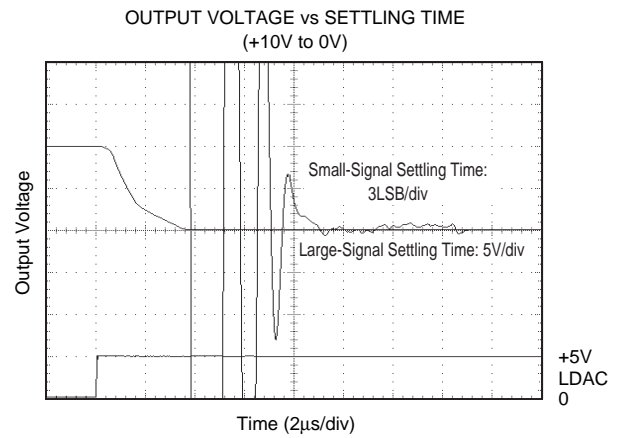
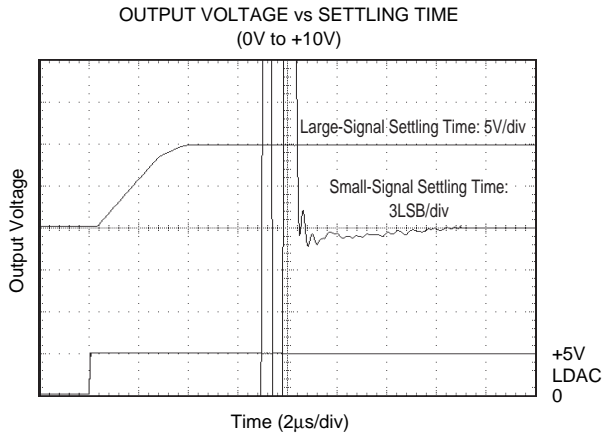

TYPICAL PERFORMANCE CURVES: $V_{SS} = 0V$ (Cont.)

At $T_A = +25^\circ C$, $V_{DD} = +5V$, $V_{CC} = +15V$, $V_{SS} = 0$, $V_{REFH} = +10V$, and $V_{REFL} = 0V$, representative unit, unless otherwise specified.

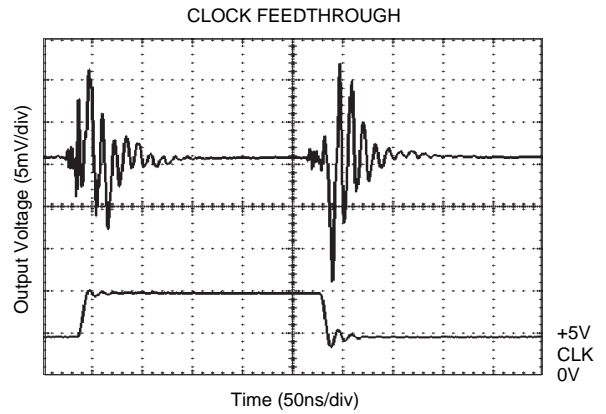
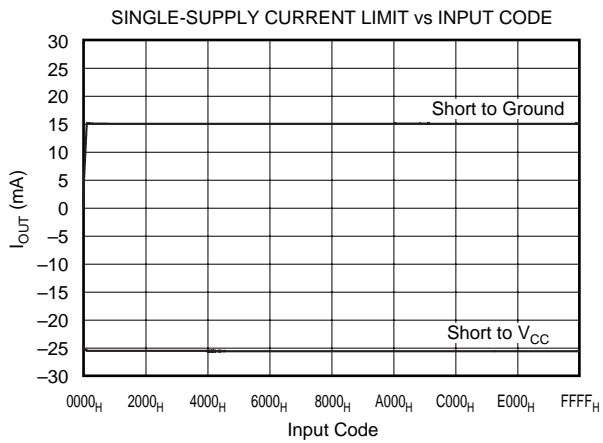
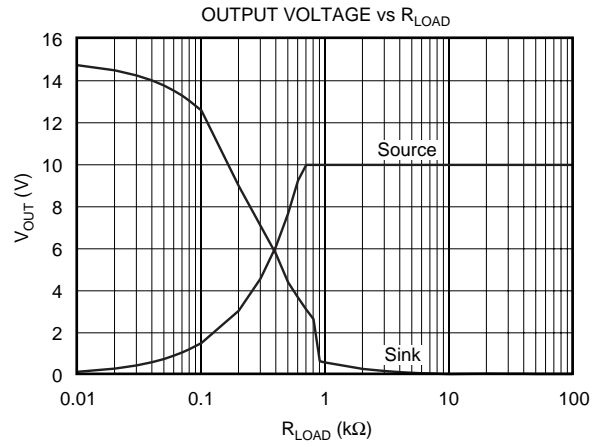
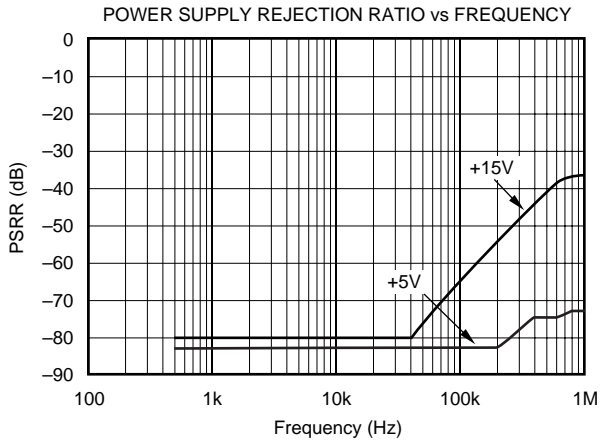

TYPICAL PERFORMANCE CURVES: $V_{SS} = -15V$

At $T_A = +25^\circ C$, $V_{DD} = +5V$, $V_{CC} = +15V$, $V_{SS} = -15V$, $V_{REFH} = +10V$, and $V_{REFL} = -10V$, representative unit, unless otherwise specified.

+25°C

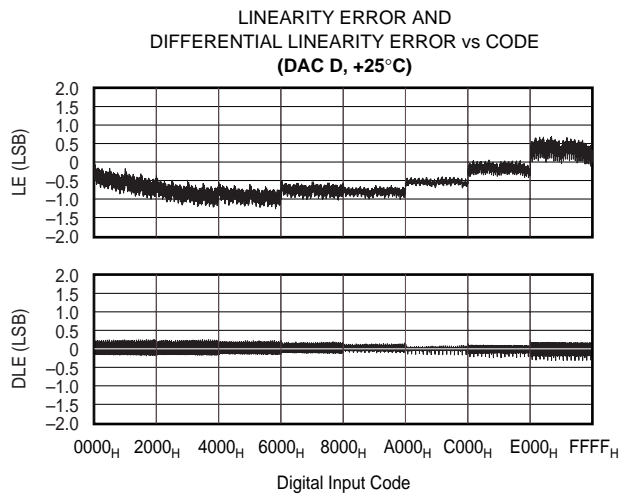
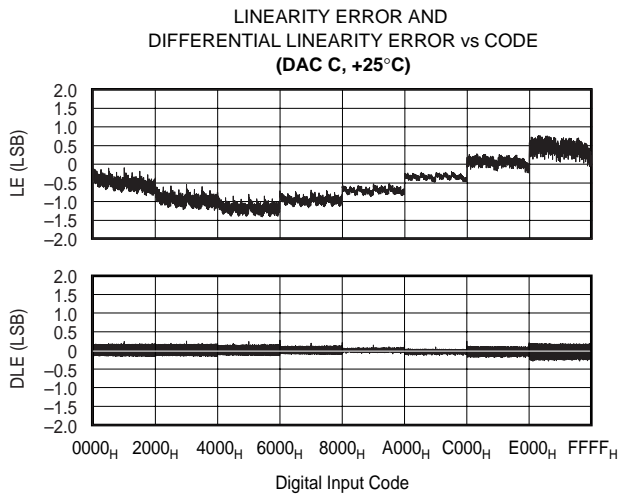
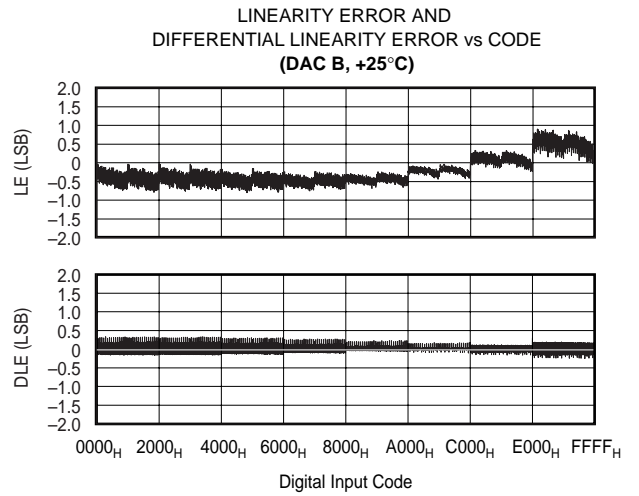
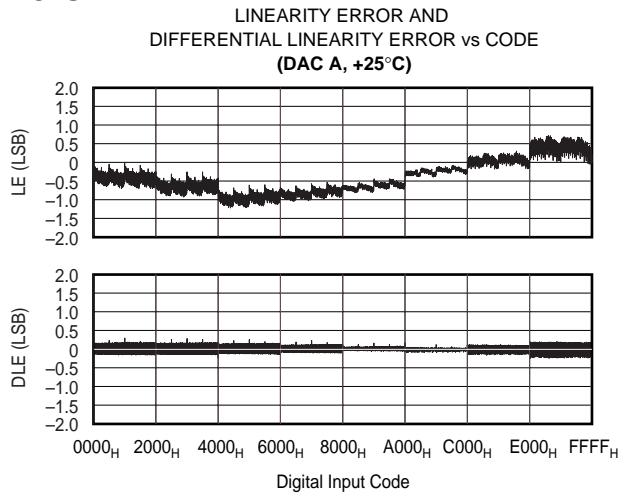

+85°C

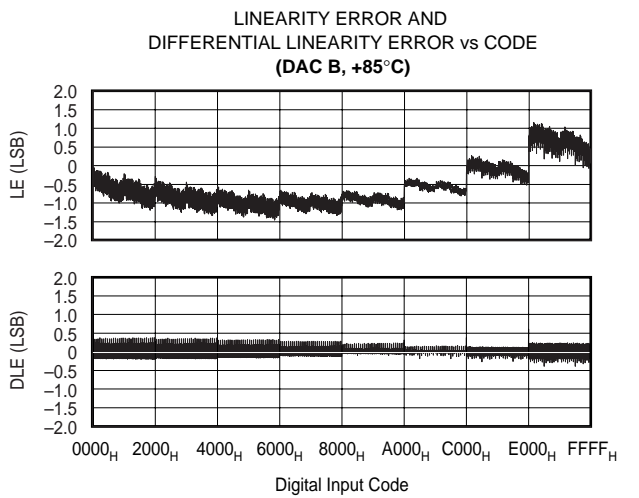
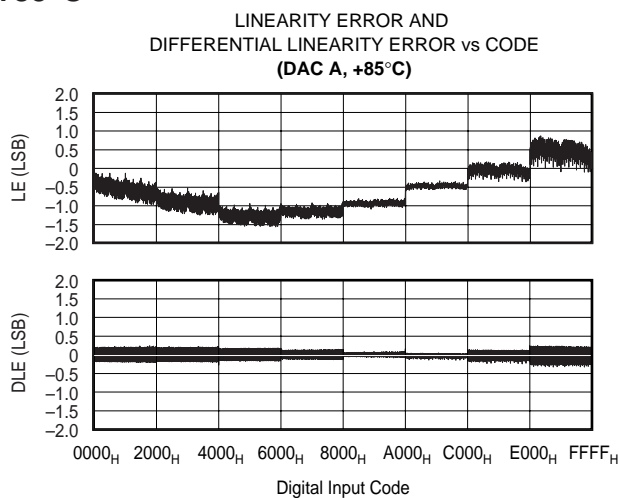

TYPICAL PERFORMANCE CURVES: $V_{SS} = -15V$ (Cont.)

At $T_A = +25^\circ C$, $V_{DD} = +5V$, $V_{CC} = +15V$, $V_{SS} = -15V$, $V_{REFH} = +10V$, and $V_{REFL} = -10V$, representative unit, unless otherwise specified.

+85°C (cont.)

LINEARITY ERROR AND DIFFERENTIAL LINEARITY ERROR vs CODE (DAC C, +85°C)

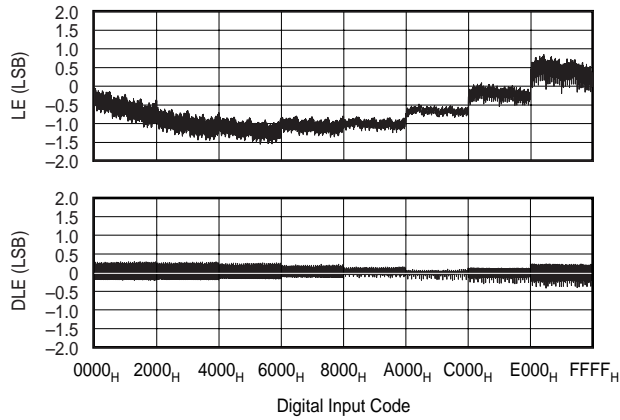

LINEARITY ERROR AND DIFFERENTIAL LINEARITY ERROR vs CODE (DAC D, +85°C)

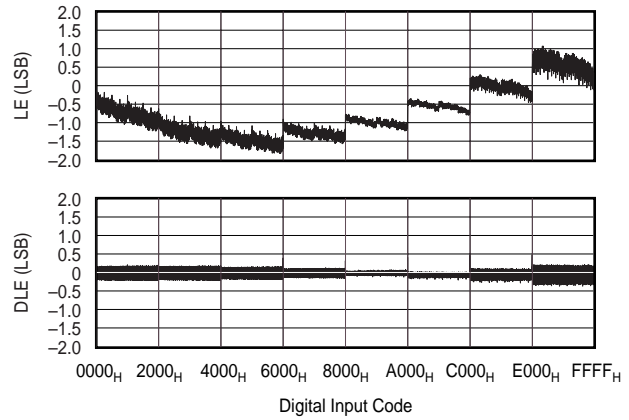

-40°C

LINEARITY ERROR AND DIFFERENTIAL LINEARITY ERROR vs CODE (DAC A, -40°C)

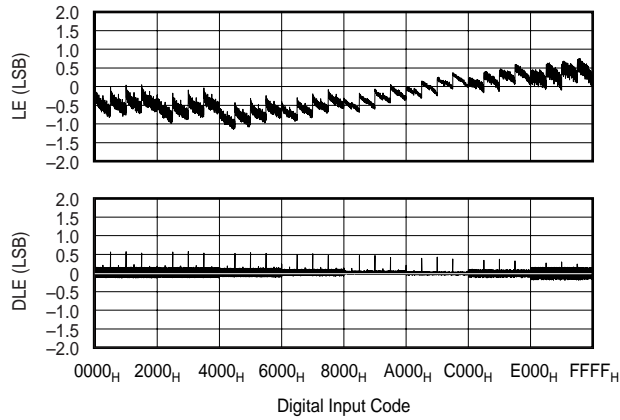

LINEARITY ERROR AND DIFFERENTIAL LINEARITY ERROR vs CODE (DAC B, -40°C)

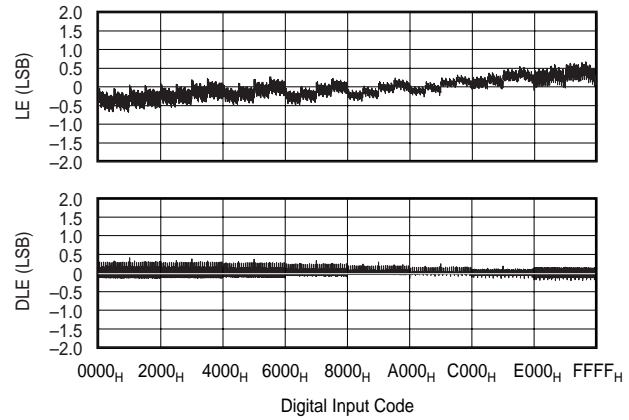

LINEARITY ERROR AND DIFFERENTIAL LINEARITY ERROR vs CODE (DAC C, -40°C)

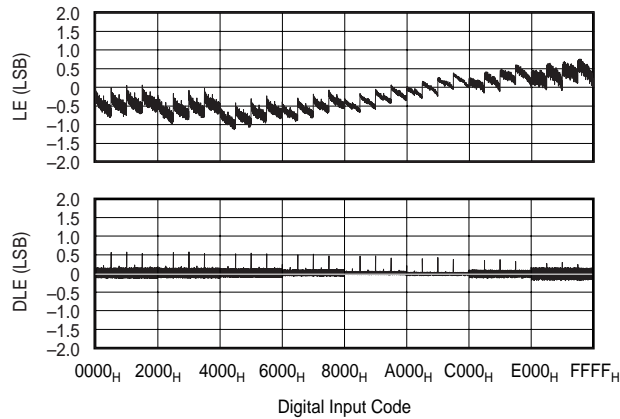

LINEARITY ERROR AND DIFFERENTIAL LINEARITY ERROR vs CODE (DAC D, -40°C)

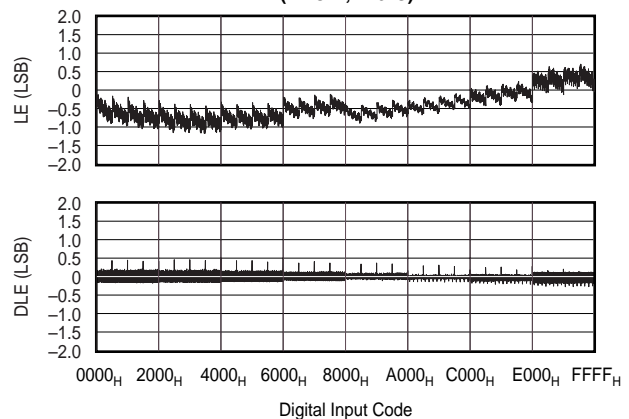

TYPICAL PERFORMANCE CURVES: $V_{SS} = -15V$ (Cont.)

At $T_A = +25^\circ C$, $V_{DD} = +5V$, $V_{CC} = +15V$, $V_{SS} = -15V$, $V_{REFH} = +10V$, and $V_{REFL} = -10V$, representative unit, unless otherwise specified.

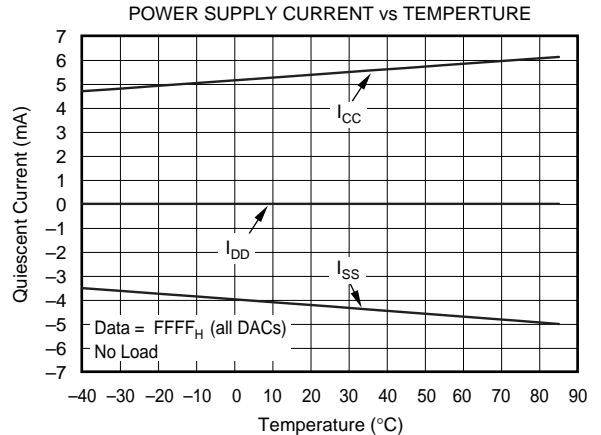
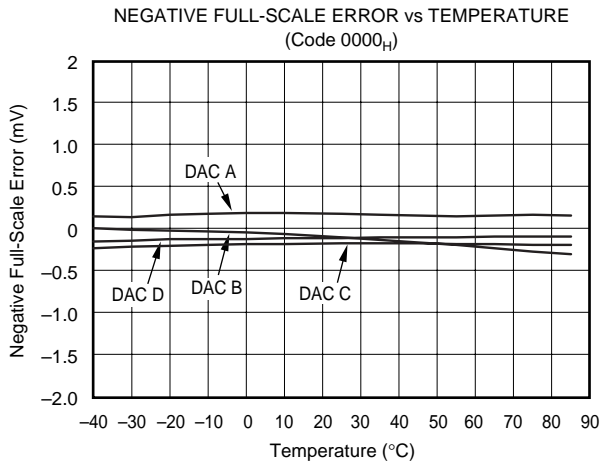
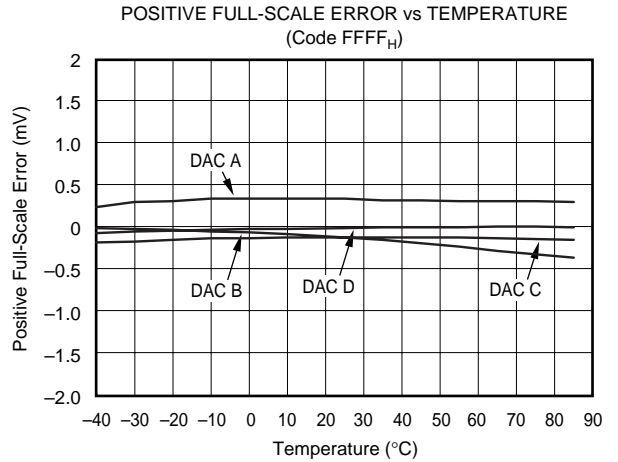
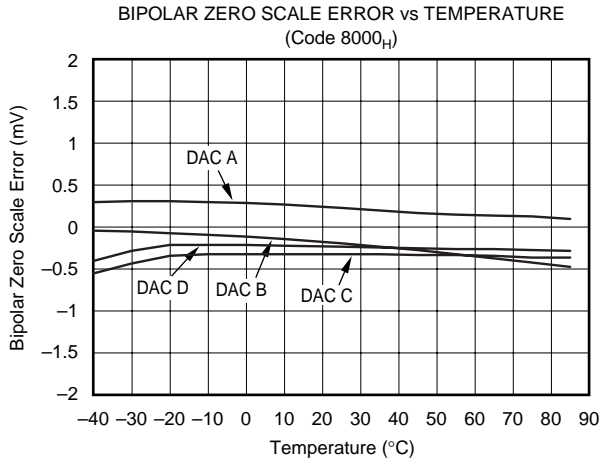
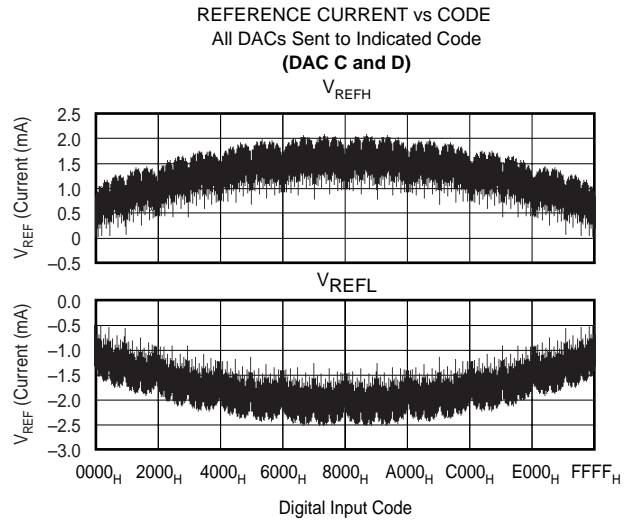
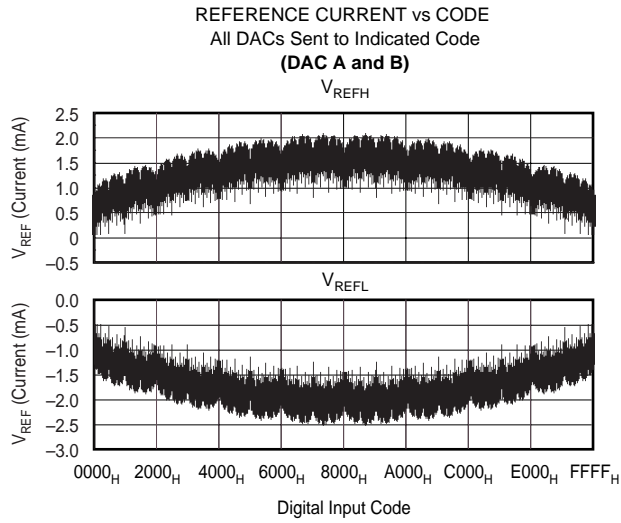

TYPICAL PERFORMANCE CURVES: $V_{SS} = -15V$ (Cont.)

At $T_A = +25^\circ C$, $V_{DD} = +5V$, $V_{CC} = +15V$, $V_{SS} = -15V$, $V_{REFH} = +10V$, and $V_{REFL} = -10V$, representative unit, unless otherwise specified.

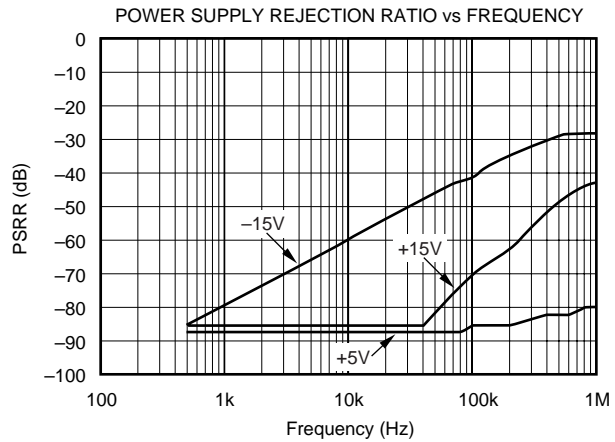
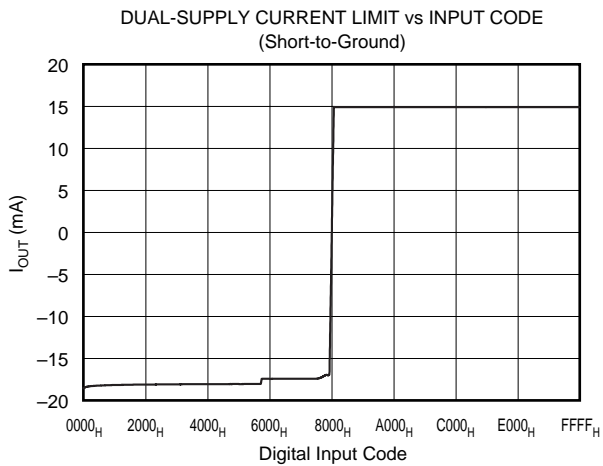
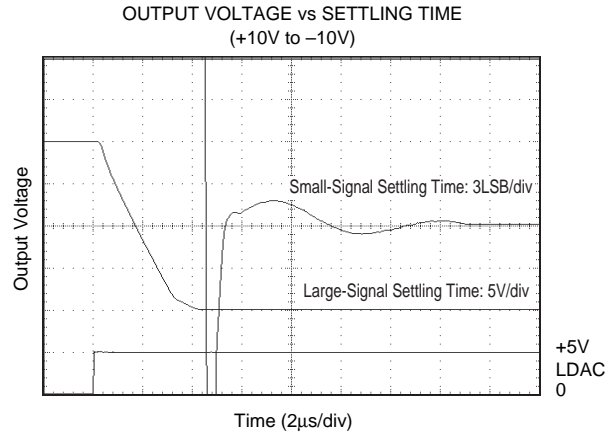
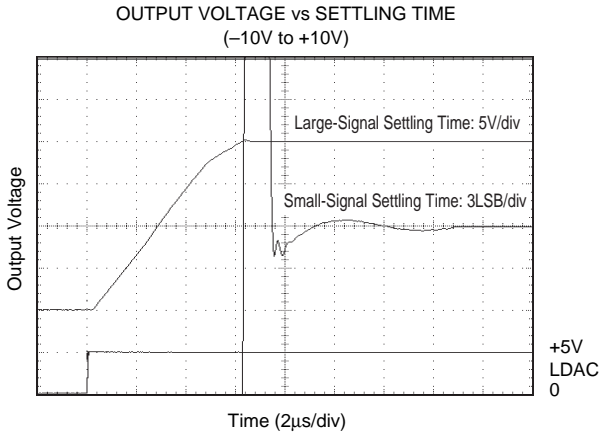
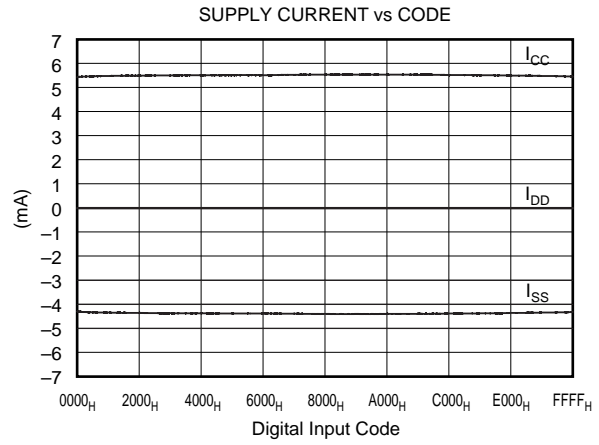
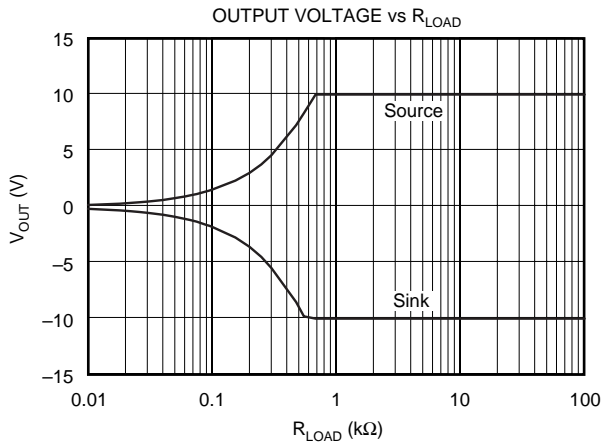

TYPICAL PERFORMANCE CURVES: $V_{SS} = -15V$ (Cont.)

At $T_A = +25^\circ C$, $V_{DD} = +5V$, $V_{CC} = +15V$, $V_{SS} = -15V$, $V_{REFH} = +10V$, and $V_{REFL} = -10V$, representative unit, unless otherwise specified.

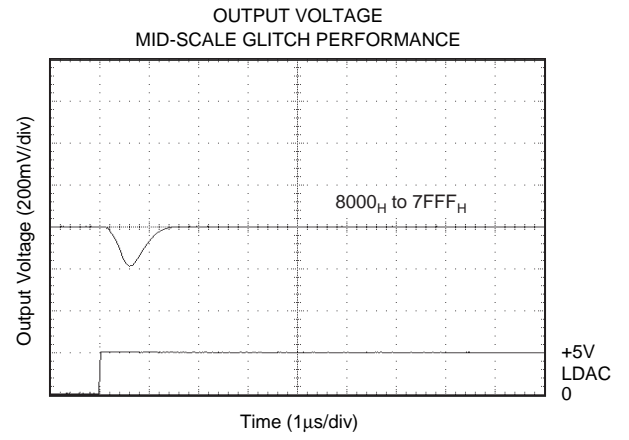
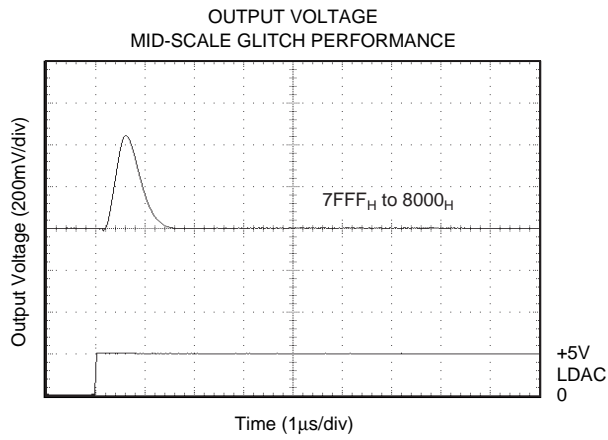

THEORY OF OPERATION

The DAC7734 is a quad voltage output, 16-bit Digital-to-Analog Converter (DAC). The architecture is an R-2R ladder configuration with the three MSB's segmented, followed by an operational amplifier that serves as a buffer. Each DAC has its own R-2R ladder network, segmented MSBs, and output op amp, as shown in Figure 1. The minimum voltage output (zero-scale) and maximum voltage output (full-scale) are set by the external voltage references V_{REFL} and V_{REFH} .

The digital input is a 24-bit serial word that contains a 2-bit address code for selecting one of four DACs, a quick load bit, five unused bits and the 16-bit DAC code (MSB first). The converters can be powered from either a single +15V supply or a dual $\pm 15V$ supply and a +5V logic supply. The device offers a reset function which immediately sets all DAC output voltages and DAC registers to mid-scale code 8000_H or to zero-scale, code 0000_H . See Figures 2 and 3 for the basic operation of the DAC7734.

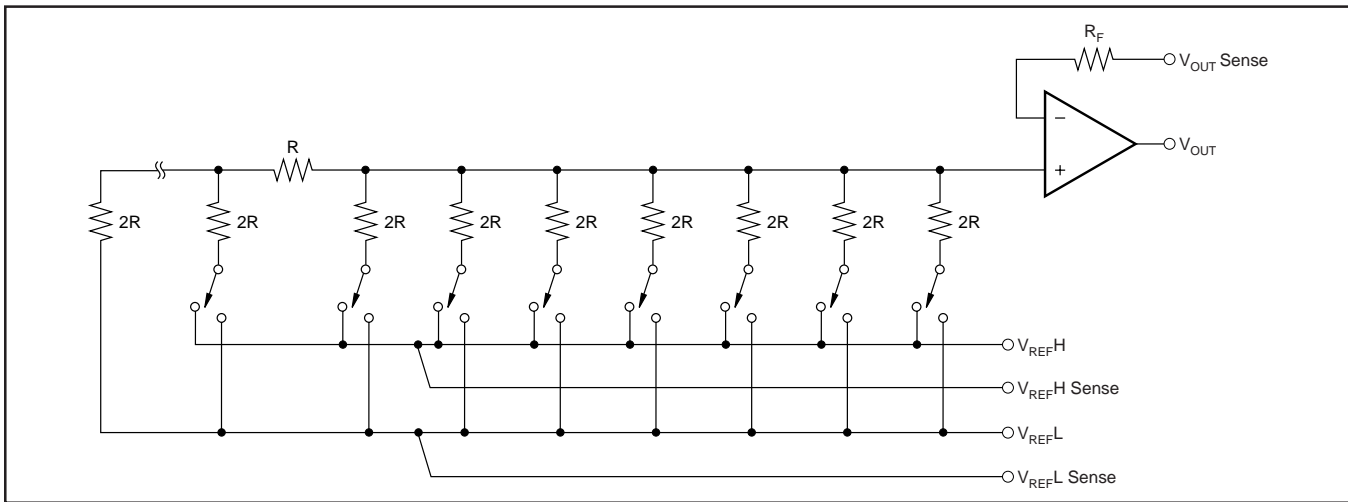

FIGURE 1. DAC7734 Architecture.

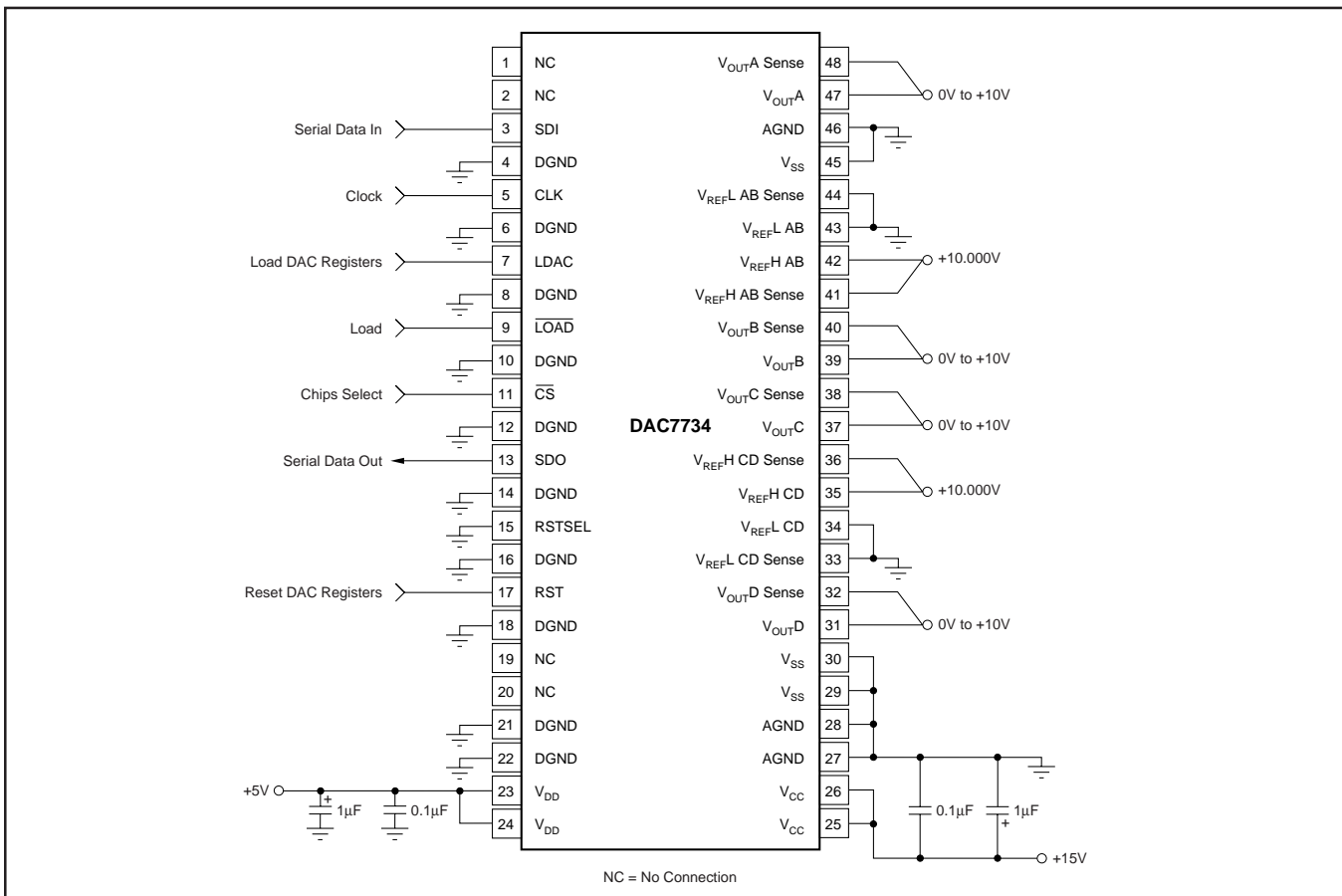

FIGURE 2. Basic Single-Supply Operation of the DAC7734.

REFERENCE INPUTS

The reference inputs, V_{REFL} and V_{REFH} , can be any voltage between $V_{SS} + 4V$ and $V_{CC} - 4V$, provided that V_{REFH} is at least 1.25V greater than V_{REFL} . The minimum output of each DAC is equal to V_{REFL} plus a small offset voltage (essentially, the offset of the output op amp). The maximum output is equal to V_{REFH} plus a similar offset voltage. Note that V_{SS} (the negative power supply) must either be connected to ground or must be in the range of $-14.25V$ to $-15.75V$. The voltage on V_{SS} sets several bias points within the converter. If V_{SS} is not in one of these two configurations, the bias values may be in error and proper operation of the device is not guaranteed.

The current into the V_{REFH} input and out of V_{REFL} depends on the DAC output voltages, and can vary from a few microamps to approximately 2.0mA. The reference input appears as a varying load to the reference. The DAC7734 features a reference drive and sense connection such that the internal errors caused by the changing reference current and the circuit impedances can be minimized. Figures 5 through 9 show different reference configurations, and the effect on the linearity and differential linearity.

The analog supplies have to come up first. If V_{CC} and V_{SS} don't come up together, then V_{SS} should come up first. If the power supplies for the reference come up first, then the V_{CC} and V_{SS} supplies will be "powered from the reference via the ESD protection diode", see page 4.

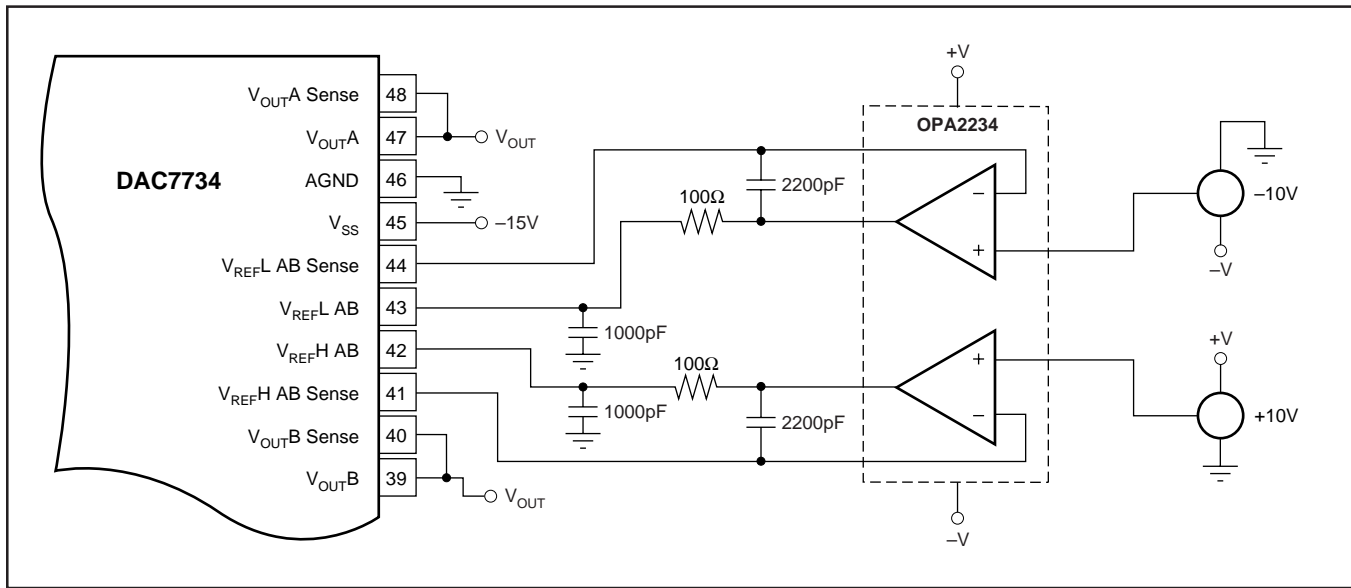

FIGURE 5. Dual Supply Configuration-Buffered References, used for Dual Supply Performance (1/2 DAC7734).

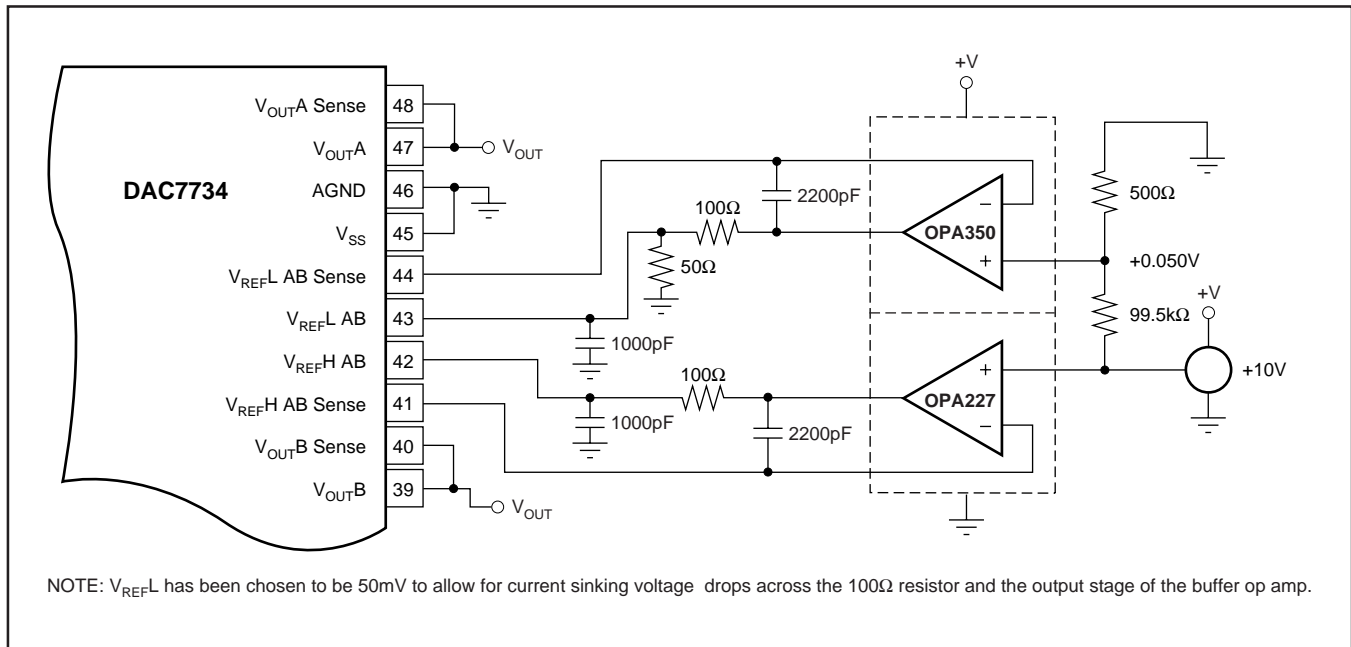

FIGURE 6. Single-Supply Buffered Reference with a Reference Low of 50mV used for Single-Supply Performance Curves (1/2 DAC7734).

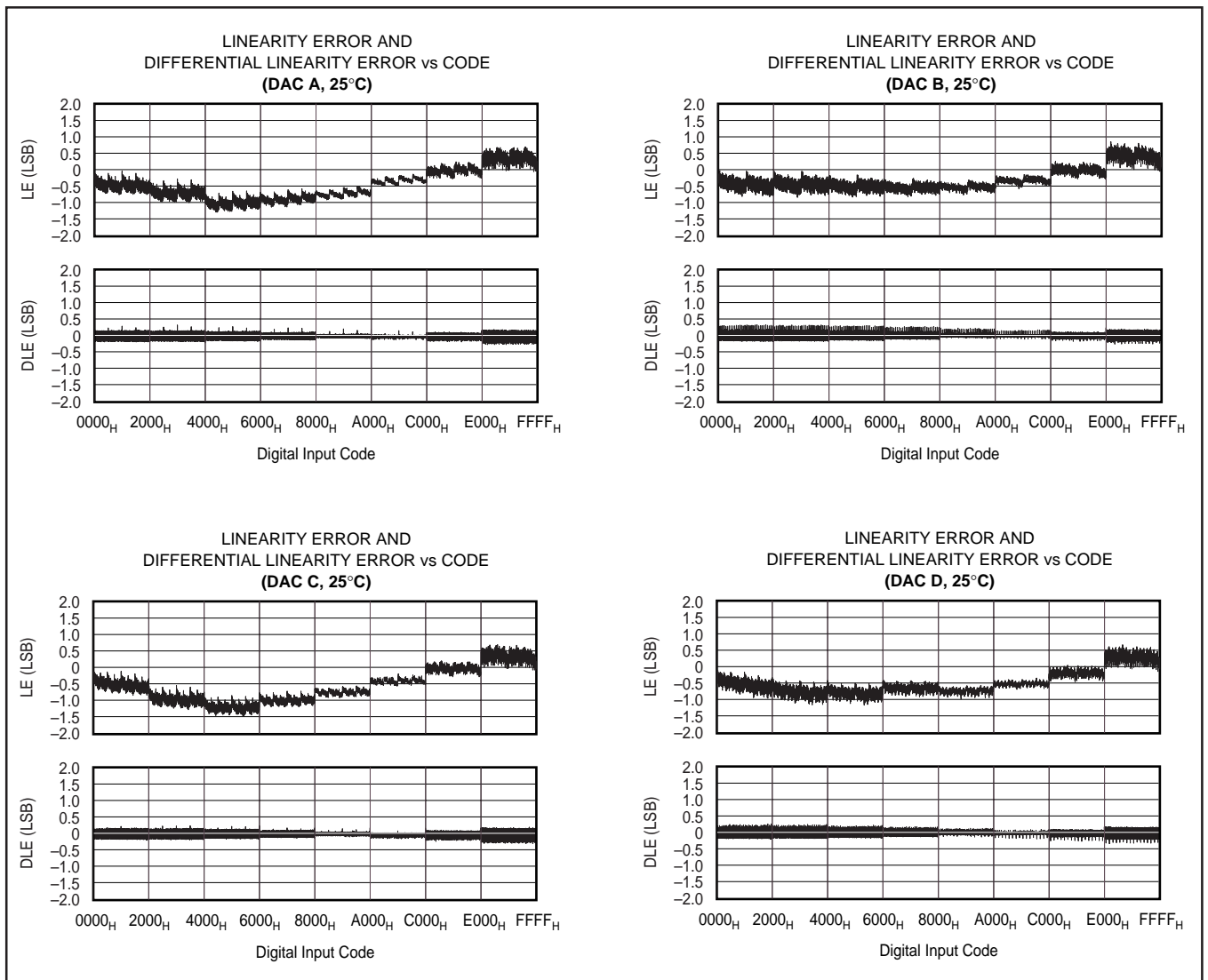

FIGURE 7. Integral Linearity and Differential Linearity Error Curves for Figure 8.

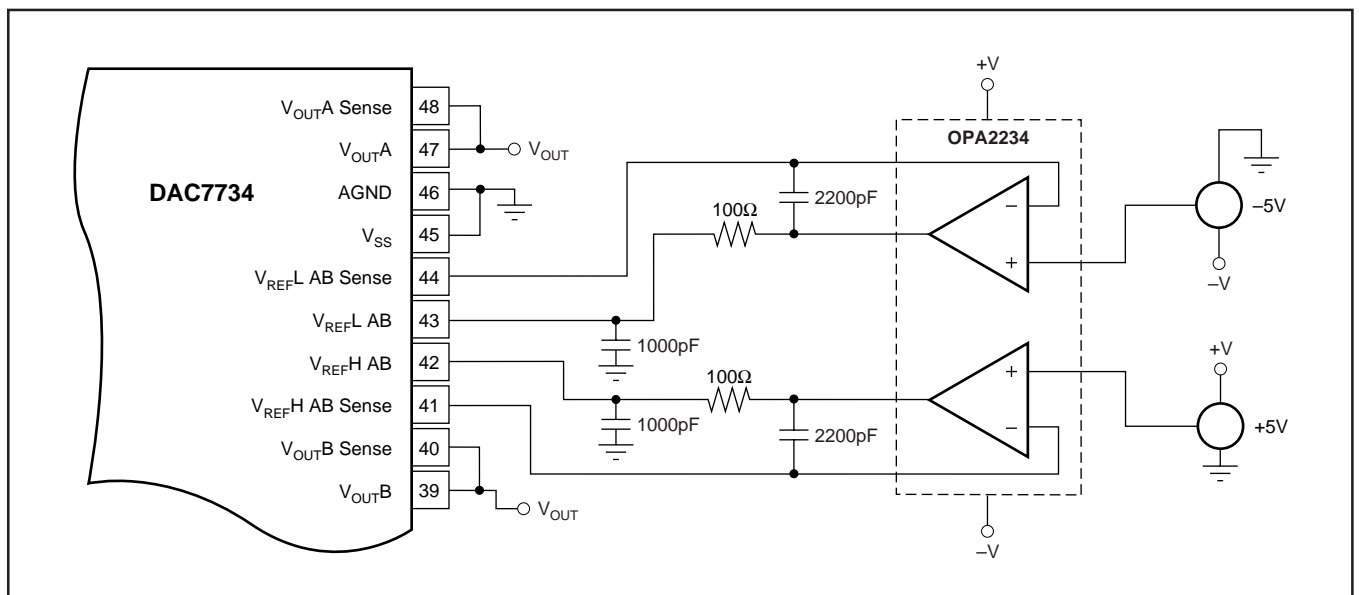

FIGURE 8. Dual-Supply Buffered Reference with $V_{REF L} = -5V$ and $V_{REF H} = +5V$ (1/2 DAC7734).

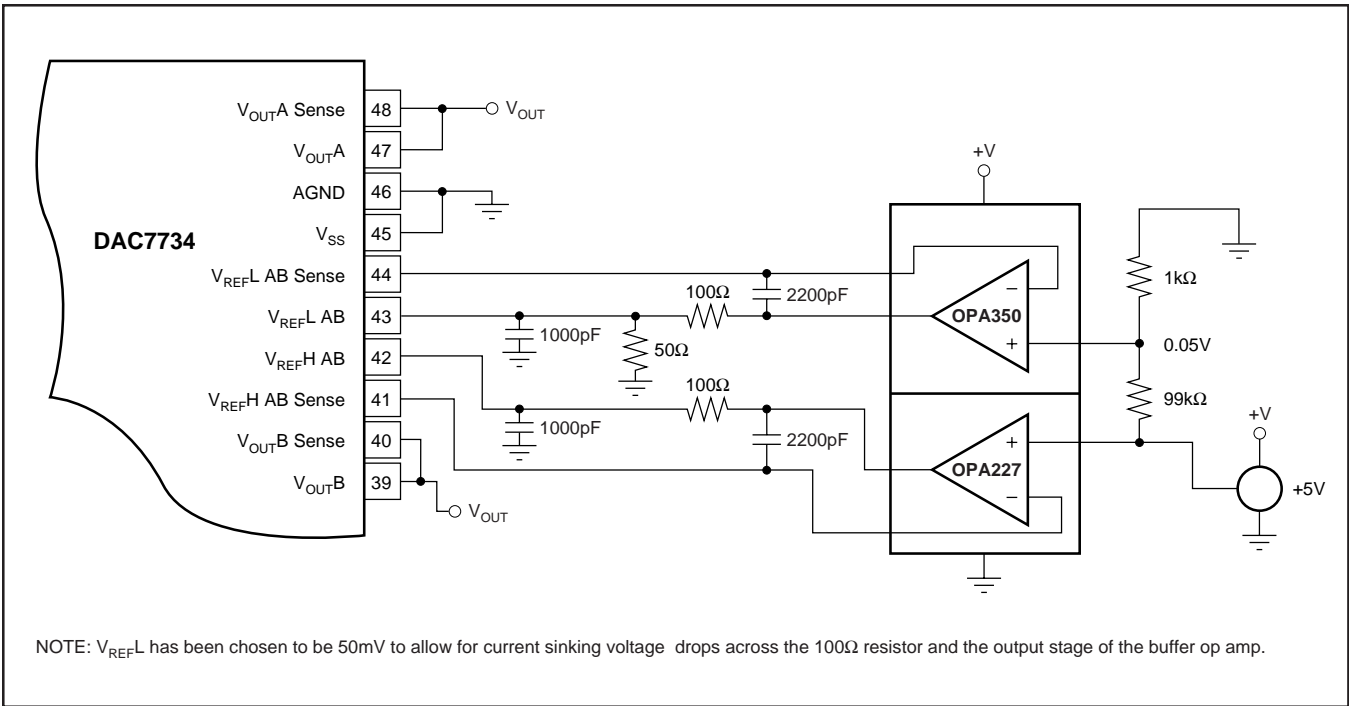

FIGURE 9. Single-Supply Buffered Reference with a Reference Low of 50mV and Reference High of +5V.

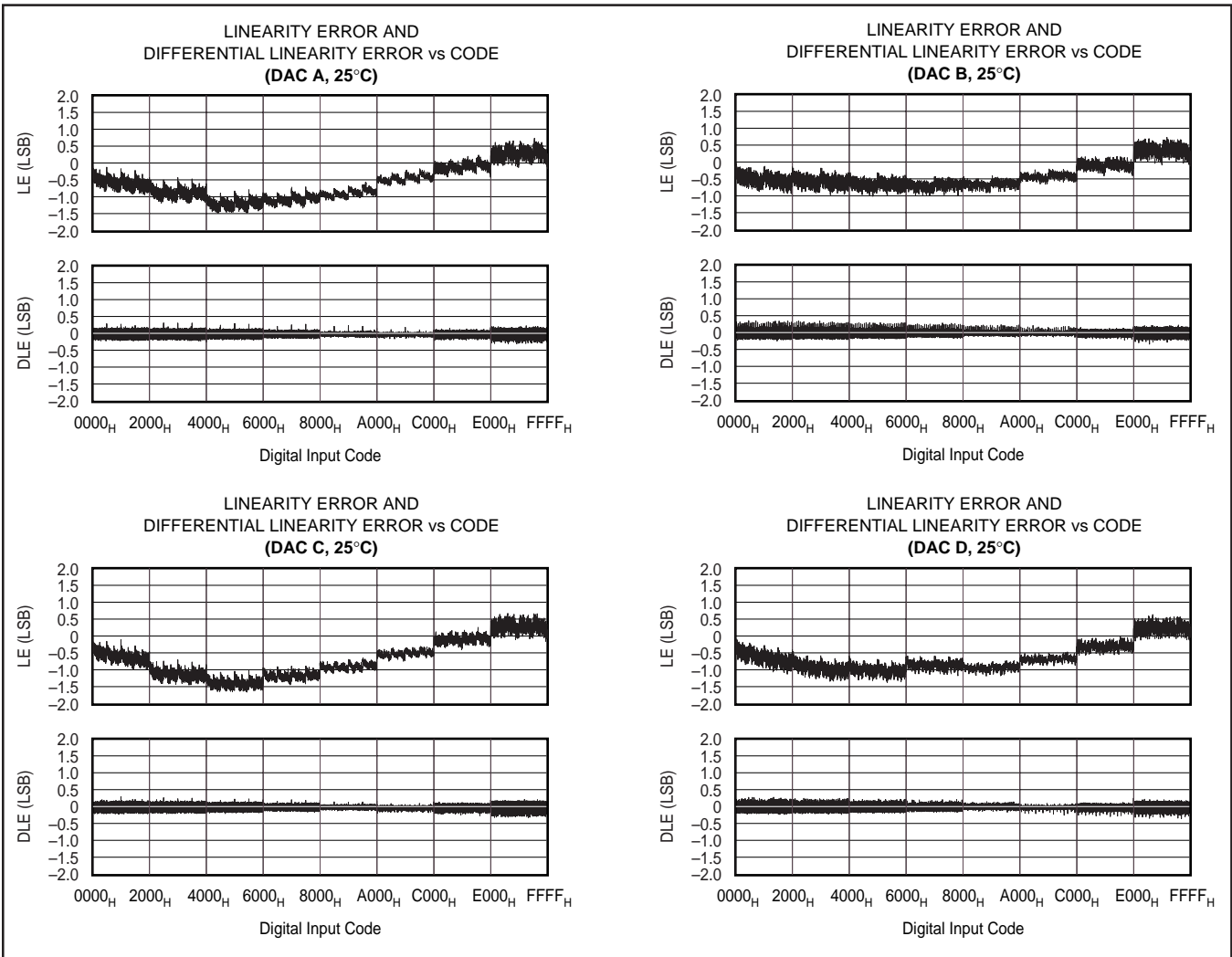

FIGURE 10. Integral Linearity and Differential Linearity Error Curves for Figure 9.

DIGITAL INTERFACE

Table I shows the basic control logic for the DAC7734. The interface consists of a Signal Data Clock (CLK) input, Serial Data (SDI), DAC Input Register Load Control Signal ($\overline{\text{LOAD}}$), and DAC Register Load Control Signal (LDAC). In addition, a Chip Select ($\overline{\text{CS}}$) input is available to enable serial communication when there are multiple serial devices. An asynchronous Reset (RST) input, by the rising edge, is provided to simplify start-up conditions, periodic resets, or emergency resets to a known state, depending on the status of the reset select (RSTSEL) signal.

The DAC code, quick load control, and address are provided via a 24-bit serial interface (see Table I). The first two bits shifted into the shift register, B23 and B22, are the DAC register address. These bits select the input register that will be updated when $\overline{\text{LOAD}}$ goes LOW. The third bit, B21, is a “Quick Load” bit such that if HIGH, the code in the shift register is loaded into ALL DAC input registers when the $\overline{\text{LOAD}}$ signal goes LOW, independent of the state of the address bits, B23 and B22. If the “Quick Load” bit is LOW, the contents of the shift register is loaded only to the DAC register that is addressed. Bits B20 through B16 are not used and can assume any logical value. The last sixteen bits, B15 through B0, make up the DAC code to be loaded into the selected input register.

The internal DAC register is edge triggered and not level triggered. When the LDAC signal is transitioned from LOW to HIGH, the digital word currently in the DAC input register is latched. The first set of registers (the DAC input registers) are level triggered via the $\overline{\text{LOAD}}$ signal. This double-buffered architecture has been designed so that new data can be entered for each DAC without disturbing the analog outputs. When the new data has been entered into the

device, all of the DAC outputs can be updated simultaneously by the rising edge of LDAC. Additionally, it allows the DAC input registers to be written to at any point, then the DAC output voltages can be synchronously changed via a trigger signal (LDAC).

Note that $\overline{\text{CS}}$ and CLK are combined with an OR gate, which controls the serial-to-parallel shift register. These two inputs are completely interchangeable. In addition, care must be taken with the state of CLK when $\overline{\text{CS}}$ rises at the end of a serial transfer. If CLK is LOW when $\overline{\text{CS}}$ rises, the OR gate will provide a rising edge to the shift register, shifting the internal data one additional bit. The result will be incorrect data and possible selection of the wrong input register(s). If both $\overline{\text{CS}}$ and CLK are used, $\overline{\text{CS}}$ should rise only when CLK is HIGH. If not, then either $\overline{\text{CS}}$ or CLK can be used to operate the shift register. See Table II for more information.

$\overline{\text{CS}}^{(1)}$	CLK ⁽¹⁾	$\overline{\text{LOAD}}$	RST	SERIAL SHIFT REGISTER
H ⁽²⁾	X ⁽³⁾	H	H	No Change
L ⁽⁴⁾	L	H	H	No Change
L	\uparrow ⁽⁵⁾	H	H	Advanced One Bit
\uparrow	L	H	H	Advanced One Bit
H ⁽⁶⁾	X	L ⁽⁷⁾	H	No Change
H ⁽⁶⁾	X	H	\uparrow ⁽⁸⁾	No Change

NOTES: (1) $\overline{\text{CS}}$ and CLK are interchangeable. (2) H = Logic HIGH. (3) X = Don't Care. (4) L = Logic LOW (5) = Positive Logic Transition. (6) A HIGH value is suggested in order to avoid a “false clock” from advancing the shift register and changing the shift register. (7) If data is clocked into the serial register while $\overline{\text{LOAD}}$ is LOW, the selected DAC register will change as the shift register bits “flow” through A1 and A0. This will corrupt the data in each DAC register that has been erroneously selected. (8) Rising edge of RST causes no change in the contents of the serial shift register.

TABLE II. Serial Shift Register Truth Table.

SERIAL DATA INPUT

B23	B22	B21	B20	B19	B18	B17	B16	B15	B14	B13	B12	B11	B10	B9	B8	B7	B6	B5	B4	B3	B2	B1	B0
A1	A0	QUICK LOAD	X	X	X	X	X	D15	D14	D13	D12	D11	D10	D9	D8	D7	D6	D5	D4	D3	D2	D1	D0

A1	A0	$\overline{\text{CS}}$	RST	RSTSEL	LDAC	$\overline{\text{LOAD}}$	INPUT REGISTER	DAC REGISTER	MODE	DAC
L	L	L	H	X	X	L	Write	Hold	Write Input	A
L	H	L	H	X	X	L	Write	Hold	Write Input	B
H	L	L	H	X	X	L	Write	Hold	Write Input	C
H	H	L	H	X	X	L	Write	Hold	Write Input	D
X	X	H	H	X	\uparrow	H	Hold	Write	Update	All
X	X	H	H	X	H	H	Hold	Hold	Hold	All
X	X	X	\uparrow	L	X	X	Reset to Zero	Reset to Zero	Reset to Zero	All
X	X	X	\uparrow	H	X	X	Reset to Midscale	Reset to Midscale	Reset to Midscale	All

TABLE I. DAC7734 Logic Truth Table.

SERIAL-DATA OUTPUT

The Serial-Data Output (SDO) is the internal shift register's output. For DAC7734, the SDO is a driven output and does not require an external pull-up. Any number of DAC7734's can be daisy chained by connecting the SDO pin of one device to the SDI pin of the following device in the chain, as shown in Figure 11.

DIGITAL TIMING

Figure 12 and Table III provide detailed timing for the digital interface of the DAC7734.

DIGITAL INPUT CODING

The DAC7734 input data is in Straight Binary format. The output voltage is given by Equation 1.

where N is the digital input code. This equation does not

$$V_{OUT} = V_{REFL} + \frac{(V_{REFH} - V_{REFL}) \cdot N}{65,536} \quad (1)$$

include the effects of offset (zero-scale) or gain (full-scale) errors.

DIGITALLY-PROGRAMMABLE CURRENT SOURCE

The DAC7734 offers a unique set of features that allows a wide range of flexibility in designing applications circuits such as programmable current sources. The DAC7734 offers both a differential reference input, as well as an open-loop configuration around the output amplifier. The open-loop configuration around the output amplifier allows a transistor to be placed within the loop to implement a digitally-programmable, unidirectional current source. The availability of a differential reference allows programmability for both the full-scale and zero-scale currents. The output current is calculated as:

$$I_{OUT} = \left(\left(\frac{V_{REFH} - V_{REFL}}{R_{SENSE}} \right) \cdot \left(\frac{N}{65,536} \right) \right) + (V_{REFL} / R_{SENSE}) \quad (2)$$

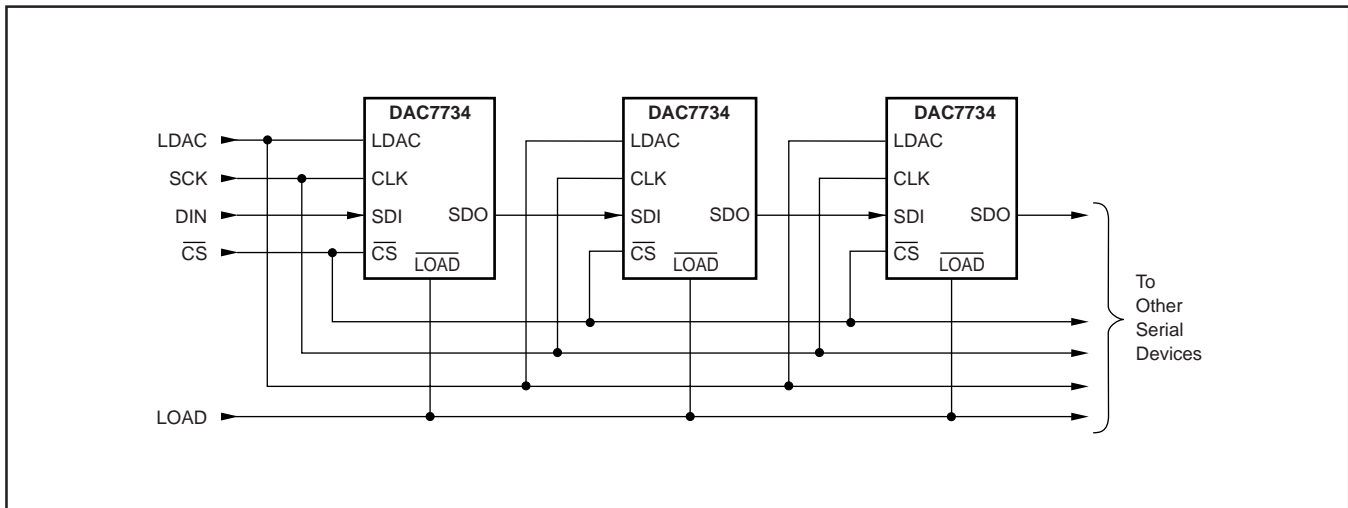

FIGURE 11. Daisy-Chaining DAC7734.

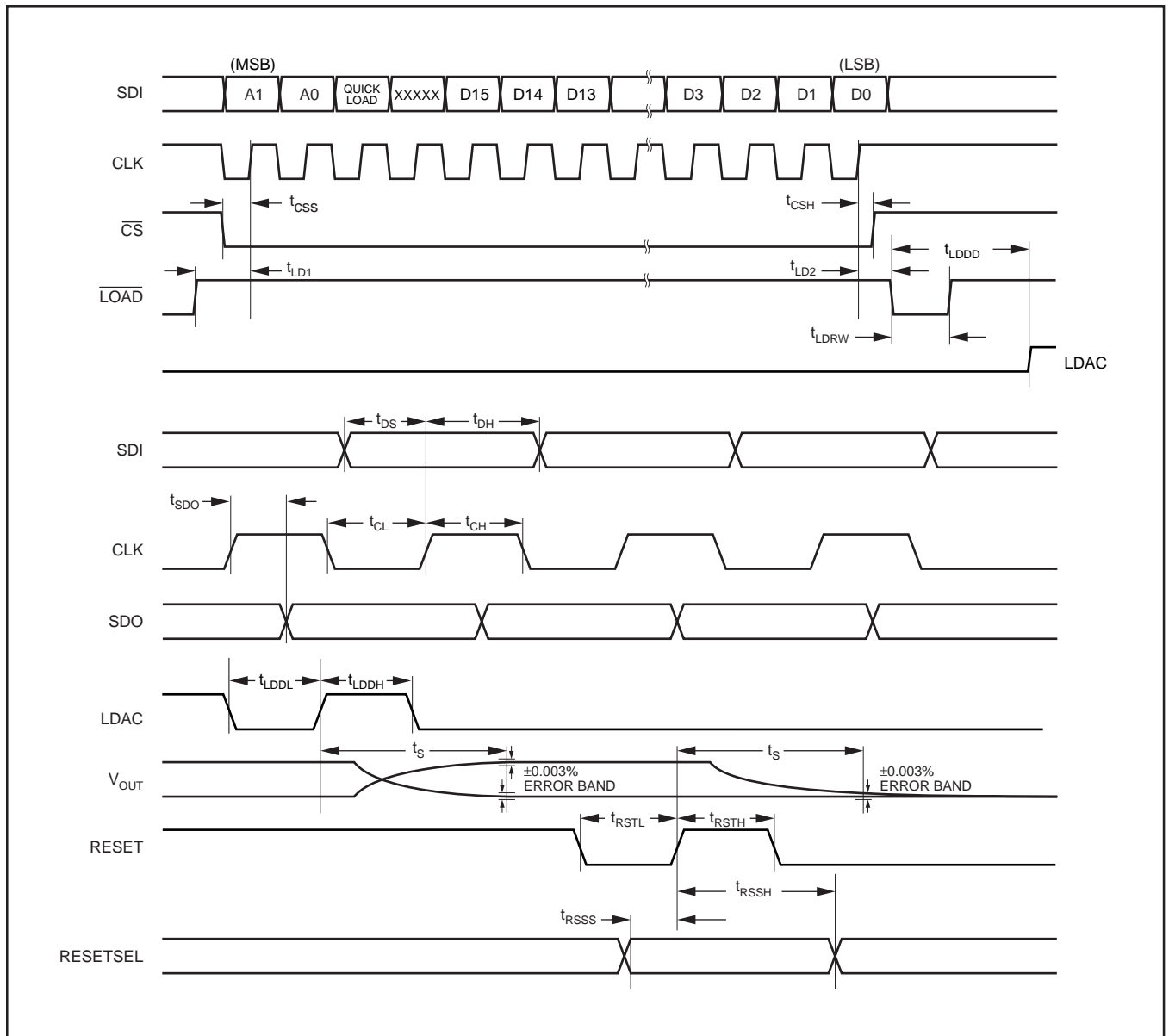

FIGURE 12. Digital Input and Output Timing.

SYMBOL	DESCRIPTION	MIN	MAX	UNITS
t_{DS}	Data Valid to CLK Rising	10		ns
t_{DH}	Data Held Valid after CLK Rises	20		ns
t_{CH}	CLK HIGH	25		ns
t_{CL}	CLK LOW	25		ns
t_{CSS}	\overline{CS} LOW to CLK Rising	15		ns
t_{CSH}	CLK HIGH to \overline{CS} Rising	0		ns
t_{LD1}	LOAD HIGH to CLK Rising	10		ns
t_{LD2}	CLK Rising to LOAD LOW	30		ns
t_{LDRW}	LOAD LOW Time	30		ns
t_{LDDWL}	LDAC LOW Time	40		ns
t_{LDDH}	LDAC HIGH Time	40		ns
t_{SDO}	SDO Propagation Delay	10	45	ns
t_{RSSS}	RESETSEL Valid to RESET HIGH	0		ns
t_{RSSH}	RESET HIGH to RESETSEL Not Valid	100		ns
t_{RSTL}	RESET LOW Time	10		ns
t_{RSTH}	RESET HIGH Time	10		ns
t_{LDDD}	LOAD LOW to LDAC Rising Time	40		ns
t_S	Settling Time		10 (dual)/11 (single)	μ s

TABLE III. Timing Specifications ($T_A = -40^\circ\text{C}$ to $+85^\circ\text{C}$).

Figure 13 shows a DAC7734 in a 4mA to 20mA current output configuration. The output current can be determined by Equation 3:

$$I_{OUT} = \left(\left(\frac{5V - 1V}{250\Omega} \right) \cdot \left(\frac{N}{65,536} \right) \right) + \left(\frac{1V}{250\Omega} \right) \quad (3)$$

At full-scale, the output current is 16mA, plus the 4mA, for the zero current. At zero scale the output current is the offset current of 4mA (1V/250Ω).

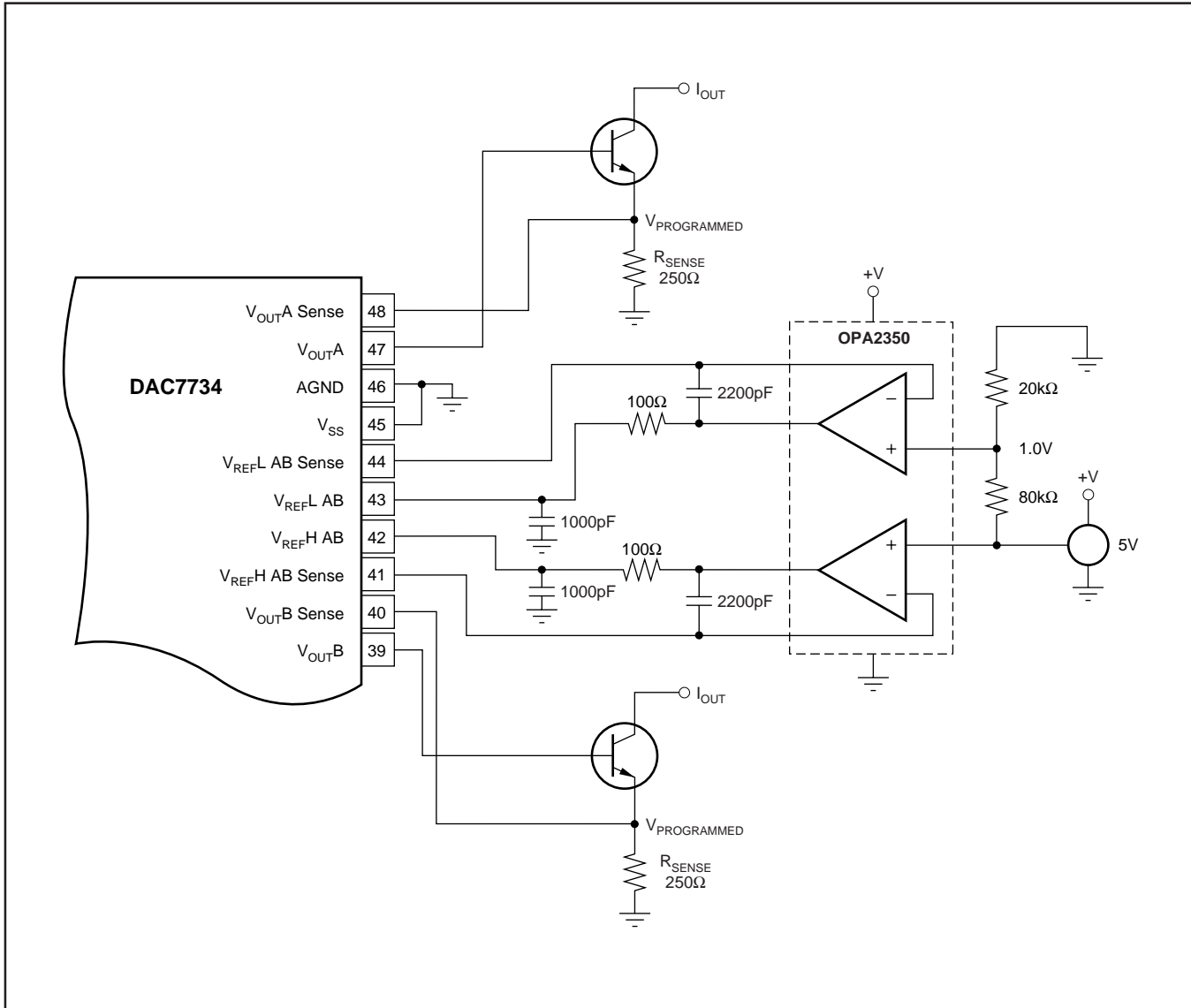

FIGURE 13. 4-to-20mA Digitally Controlled Current Source (1/2 DAC7734).