

Features

- Glass Passivated Die Construction
- Diffused Junction
- Fast Switching for High Efficiency
- High Current Capability and Low Forward Voltage Drop
- Surge Overload Rating to 30A Peak
- Plastic Material: UL Flammability Classification Rating 94V-0

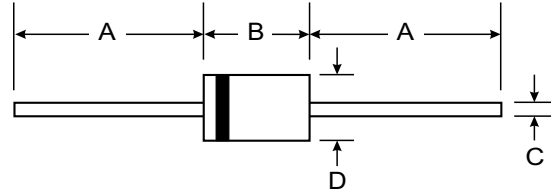

Mechanical Data

- Case: Molded Plastic
- Terminals: Plated Leads Solderable per MIL-STD-202, Method 208
- Polarity: Cathode Band
- Marking: Type Number
- DO-41 Weight: 0.35 grams (approx.)
- A-405 Weight: 0.20 grams (approx.)

Dim	DO-41		A-405	
	Min	Max	Min	Max
A	25.40	—	25.40	—
B	4.06	5.21	4.10	5.20
C	0.71	0.864	0.53	0.64
D	2.00	2.72	2.00	2.70

All Dimensions in mm

“GL” Suffix Designates A-405 Package
 “G” Suffix Designates DO-41 Package

Maximum Ratings and Electrical Characteristics @ $T_A = 25^\circ\text{C}$ unless otherwise specified

Single phase, half wave, 60Hz, resistive or inductive load.
 For capacitive load, derate current by 20%.

Characteristic	Symbol	1N4933 G/GL	1N4934 G/GL	1N4935 G/GL	1N4936 G/GL	1N4937 G/GL	Unit
Peak Repetitive Reverse Voltage	V_{RRM}	50	100	200	400	600	V
Working Peak Reverse Voltage	V_{RWM}						
DC Blocking Voltage	V_R						
RMS Reverse Voltage	$V_{R(RMS)}$	35	70	140	280	420	V
Average Rectified Output Current (Note 1)	I_O	1.0					A
		@ $T_A = 75^\circ\text{C}$					
Non-Repetitive Peak Forward Surge Current 8.3ms Single half sine-wave Superimposed on Rated Load (JEDEC Method)	I_{FSM}	30					A
Forward Voltage	V_{FM}	1.2					V
		@ $I_F = 1.0\text{A}$					
Peak Reverse Current	I_{RM}	5.0					μA
		@ $T_A = 25^\circ\text{C}$					
		@ $T_A = 100^\circ\text{C}$					
Reverse Recovery Time (Note 3)	t_{rr}	200					ns
Typical Junction Capacitance (Note 2)	C_j	15					pF
Typical Thermal Resistance Junction to Ambient	$R_{\theta JA}$	100					K/W
Operating and Storage Temperature Range	T_j, T_{STG}	-65 to +150					$^\circ\text{C}$

- Notes:
1. Valid provided that leads are maintained at ambient temperature at a distance of 9.5mm from the case.
 2. Measured at 1.0MHz and applied reverse voltage of 4.0V DC.
 3. Measured with $I_F = 0.5\text{A}$, $I_R = 1.0\text{A}$, $I_{rr} = 0.25\text{A}$.

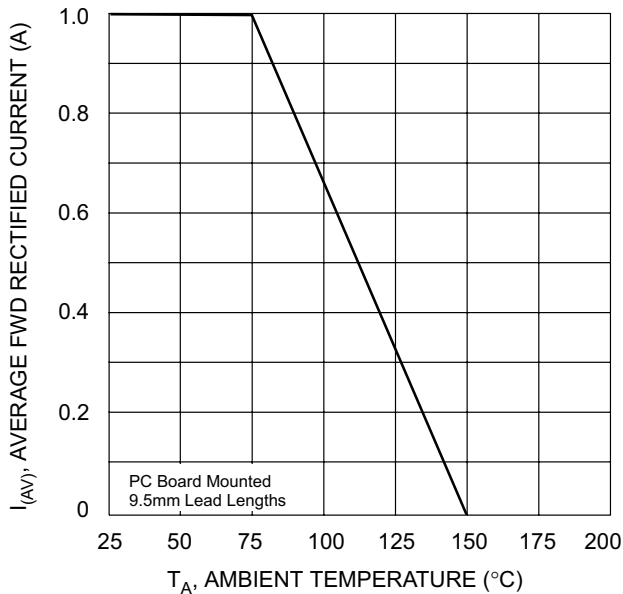

Fig. 1 Forward Current Derating Curves

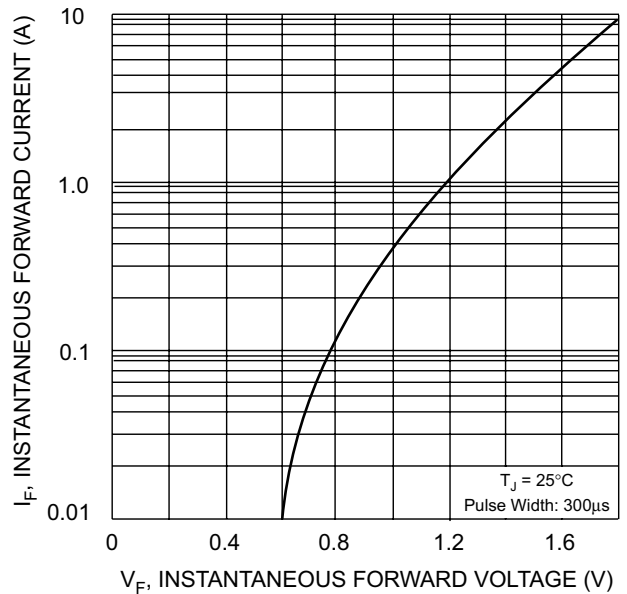

Fig. 2 Typical Forward Characteristics

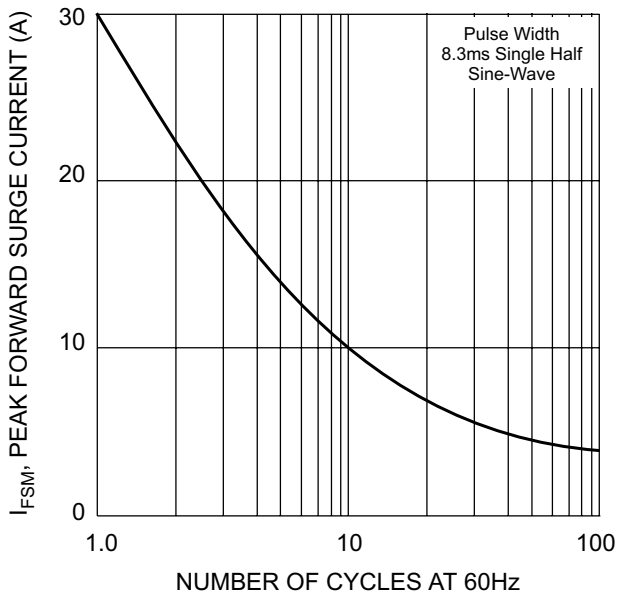

Fig. 3 Max Non-Repetitive Peak Fwd Surge Current

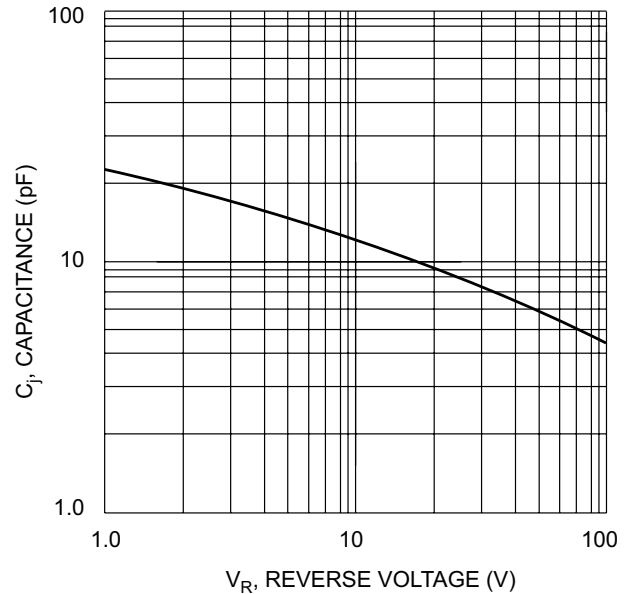
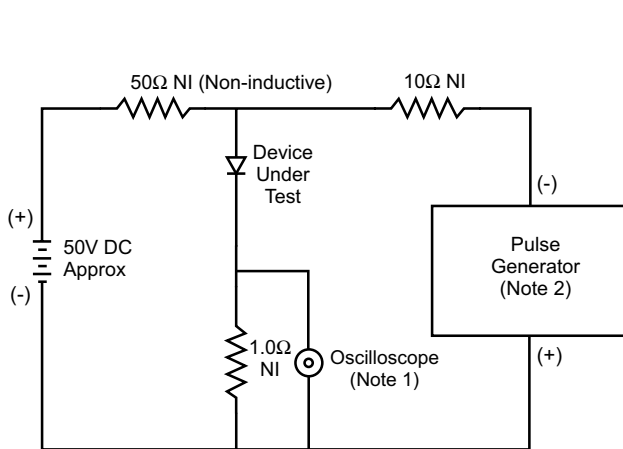
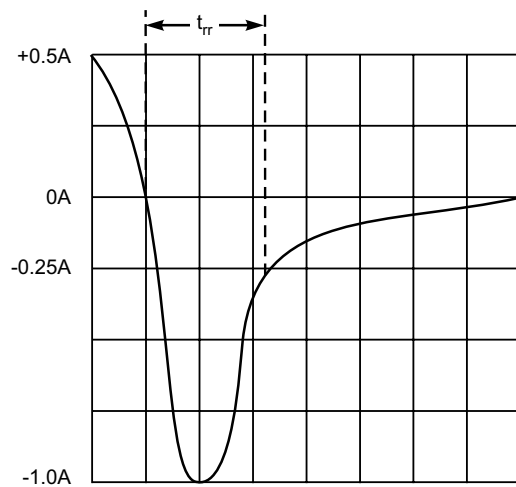

Fig. 4 Typical Junction Capacitance



- Notes:
1. Rise Time = 7.0ns max. Input Impedance = 1.0MΩ, 22pF.
 2. Rise Time = 10ns max. Input Impedance = 50Ω.



Set time base for 50/100 ns/cm

Fig. 5 Reverse Recovery Time Characteristic and Test Circuit