



Infrared Remote-control Receiver Module

MODEL NO : IRM-8752-2

■ Features :

- High protection ability to EMI and metal case can be customized.
- Mold type and metal case type to meet the design of front panel.
- Elliptic lens to improve the characteristic against
- Line-up for various center carrier frequencies.
- Low voltage and low power consumption.
- High immunity against ambient light.
- Photodiode with integrated circuit.
- TTL and CMOS compatibility.
- Long reception distance.
- High sensitivity.

■ Description :

- The device is a miniature type infrared remote control system receiver which has been developed and designed by utilizing the most updated IC technology. The PIN diode and preamplifier are assembled on lead frame, the epoxy package is designed as an IR filter. The demodulated output signal can directly be decoded by a microprocessor.

■ Applications :

1. Optical switch
 2. Light detecting portion of remote control
- AV instruments such as Audio, TV, VCR, CD, MD, etc.
 - Home appliances such as Air-conditioner, Fan , etc.
 - The other equipments with wireless remote control.
 - CATV set top boxes
 - Multi-media Equipment

PART	MATERIAL	COLOR
Chip	Silicon	Black
Shell	Tinplate	Silver-white



Infrared Remote-control Receiver Module

MODEL NO : IRM-8752-2

■ NOTES :

1. This drawing measure is a standard value.
All dimensions are in millimeter.
2. In case of designation is tolerance $\pm 0.3\text{mm}$.
3. Lead spacing is measured where the lead emerge from the package.
4. Protruded resin under flange 1.0mm Max.
5. Lens color: Black.
6. Above specification may be changed without notice. EVERLIGHT will reserve authority on material change for above specification.
7. These specification sheets include materials protected under copyright of EVERLIGHT corporation. Please don't reproduce or cause anyone to reproduce them without EVERLIGHT consent.
8. When using this produce, please observe the absolute maximum ratings and the instructions for use outlined in these specification sheets. EVERLIGHT assumes no responsibility for any damage resulting from use of the product which does not comply with the absolute maximum ratings and the instructions included in these specification sheets.

■ Package Dimension :

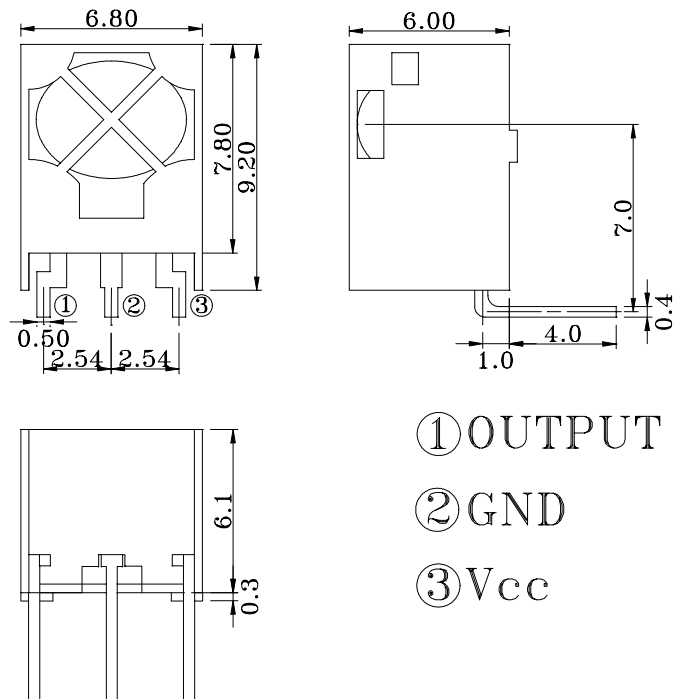



Infrared Remote-control Receiver Module

MODEL NO : IRM-8752-2

■ Absolute Maximum Ratings at T_A = 25°C

Parameter	Symbol	Rating	Unit	Notice
Supply Voltage	V _{cc}	0~6	V	
Operating Temperature	T _{opr}	-30 ~ +85	°C	
Storage Temperature	T _{stg}	-40 ~ +85	°C	
Soldering Temperature	T _{sol}	260	°C	4mm from mold body less than 5 seconds

■ Electronic Optical Characteristics :

T_A = 25°C

Parameter	Symbol	MIN.	TYP.	MAX.	Unit	Condition
Supply Voltage	V _{cc}	4.5	5	5.5	V	DC voltage
Supply Current	I _{cc}	---	---	3	mA	No signal input
B.P.F Center Frequency	F _o	---	36	---	KHz	
Peak Wavelength	λ _p	---	940	---	nm	
Reception Distance	L ₀	8	---	---	m	At the ray axis *1
	L ₄₅	4	---	---		
Half Angle(Horizontal)	Θ _h	---	45	---	deg	
Half Angle(Vertical)	Θ _v	---	35	---	deg	
High Level Pulse Width	T _H	400	---	800	μs	At the ray axis *2
Low Level Pulse Width	T _L	400	---	800	μs	
High Level Output Voltage	V _H	4.5	---	---	V	
Low Level Output Voltage	V _L	---	0.2	0.5	V	

Infrared Remote-control Receiver Module

MODEL NO : IRM-8752-2

■ Appendix of Page 3 :

- *1: The ray receiving surface at a vertex and relation to the ray axis in the range of $\theta = 0^\circ$ and $\theta = 45^\circ$.
- *2: A range from 30cm to the arrival distance. Average value of 50 pulses.

■ Test Method :

The specified electro-optical characteristics is satisfied under the following Conditions at the controllable distance.

① Measurement place

A place that is nothing of extreme light reflected in the room.

② External light

Project the light of ordinary white fluorescent lamps which are not high Frequency lamps and must be less then 10 Lux at the module surface.
 ($E_e \leq 10 \text{Lux}$)

③ Standard transmitter

A transmitter whose output is so adjusted as to **$V_o = 400 \text{mVp-p}$** and the output Wave form shown in Fig.-1. According to the measurement method shown in Fig.-2 the standard transmitter is specified.

However, the infrared photodiode to be used for the transmitter should be $\lambda_p = 940 \text{nm}$, $\Delta\lambda = 50 \text{nm}$. Also, photodiode is used of PD438B ($V_r = 5 \text{V}$).

(Standard light / Light source temperature 2856°K).

④ Measuring system

According to the measuring system shown in Fig.-3

■ Block Diagram :

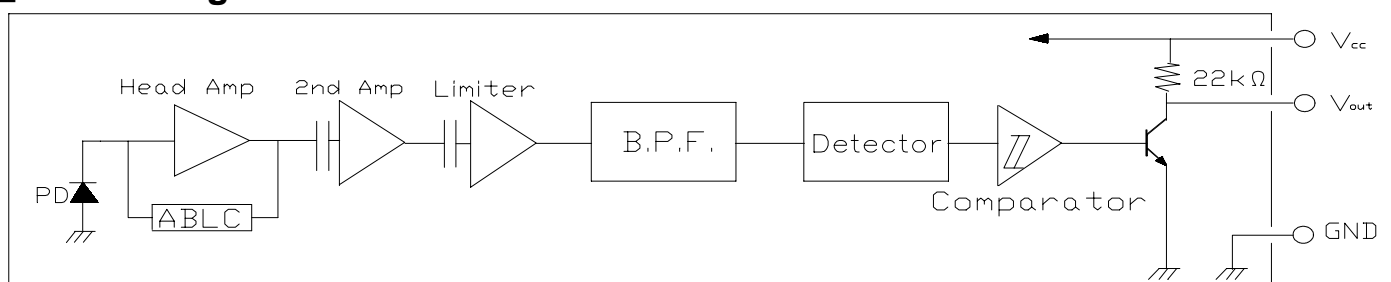

Infrared Remote-control Receiver Module

MODEL NO : IRM-8752-2

Application Circuit :

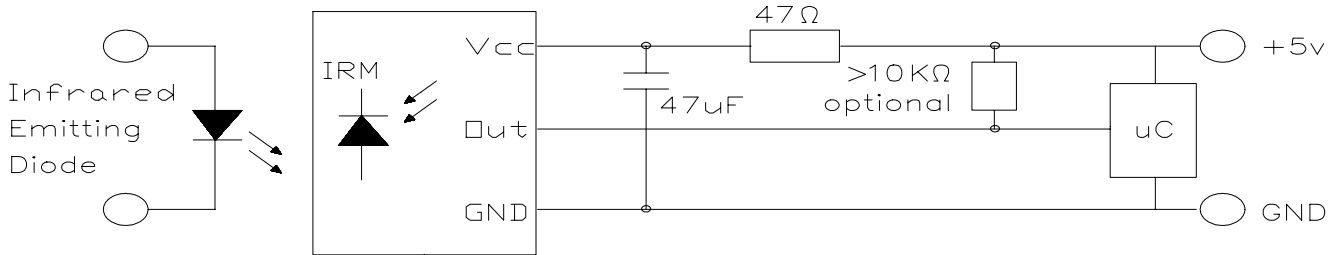

RC Filter should be connected closely between Vcc pin and GND pin.

Fig.-1 Transmitter Wave Form

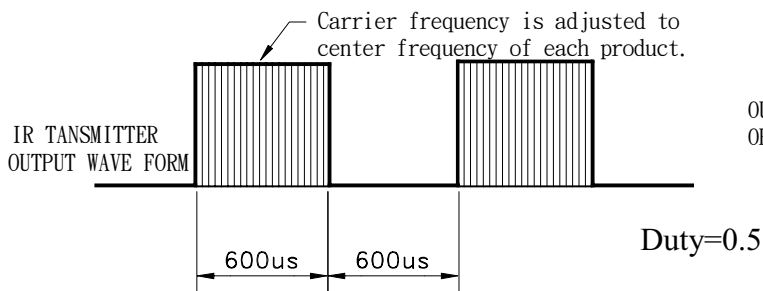

D.U.T output Pulse

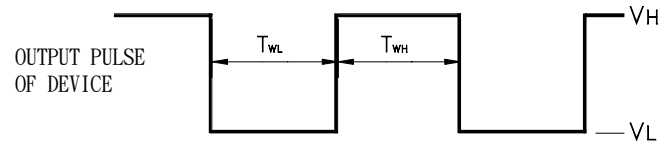

Fig.-2 Measuring Method

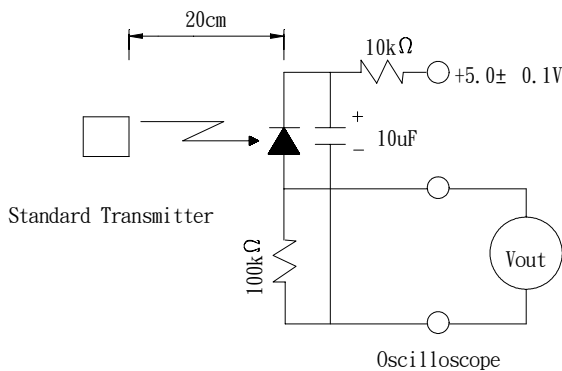
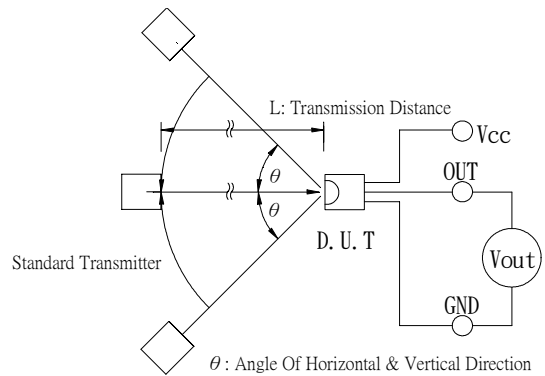

Fig.-3 Measuring System





Infrared Remote-control Receiver Module

MODEL NO : IRM-8752-2

■ TYPICAL ELECTRICAL/OPTICAL/CHARACTERISTICS CURVES

Fig.-4 Relative Spectral Sensitivity vs. Wavelength

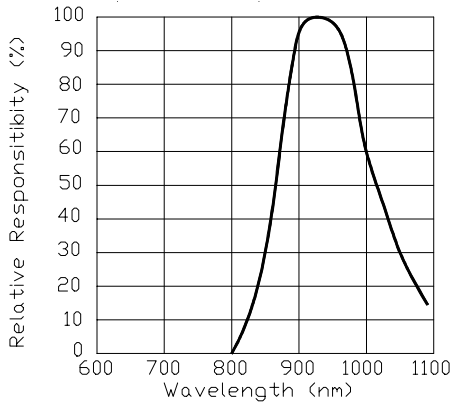

Fig.-5 Relative Transmission Distance vs. Direction

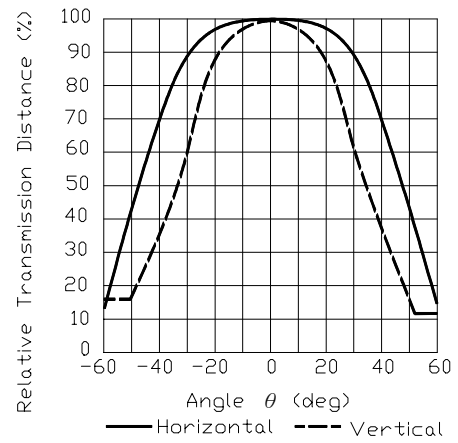

Fig.-6 Output Pulse Length vs. Arrival Distance

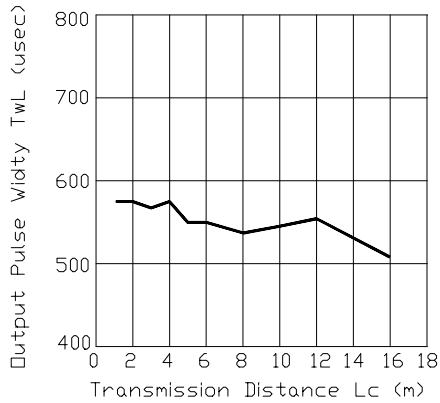

Fig.-7 Arrival Distance vs. Supply Voltage

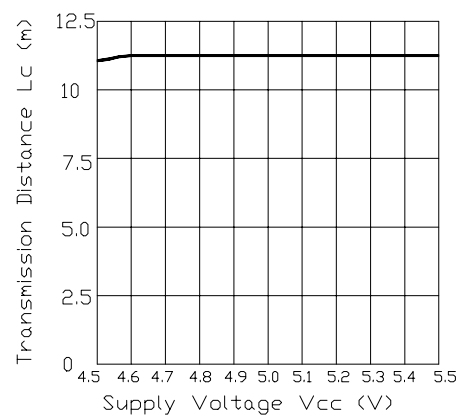

Fig.-8 Relative Transmission Distance vs. Center Carrier Frequency

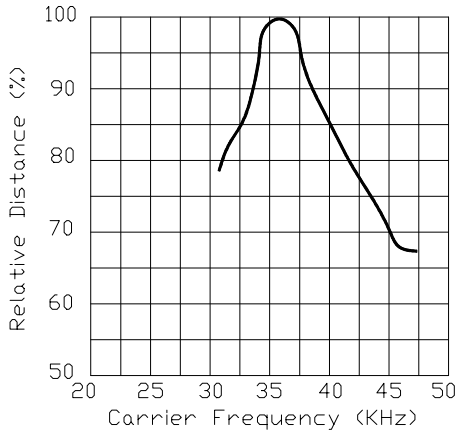
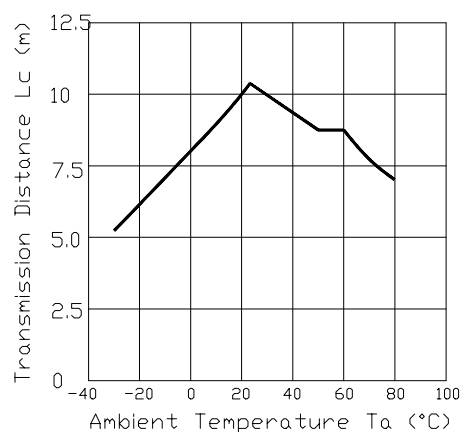

Fig.-9 Arrival Distance vs. Ambient Temperature





Infrared Remote-control Receiver Module

MODEL NO : IRM-8752-2

■ Reliability Test Item And Condition

The reliability of products shall be satisfied with items listed below.

Confidence level: 90%

LTPD: 10%

Test Items	Test Conditions	Failure Judgement Criteria	Samples(n) Defective(c)
Operation life	Vcc=5V,Ta:25°C 1000hrs	$L_0 \leq L \times 0.8$ $L_{45} \leq L \times 0.8$ L: Lower specification limit	n=22,c=0
Temperature cycle	1 cycle -40°C +25°C +85°C (30min)(5min)(30min) 50 cycle test		n=22,c=0
Thermal shock	-10°C to +100°C (5min) (10sec) (5min) 50 cycle test		n=22,c=0
High temperature storage	Temp: +85°C 1000hrs		n=22,c=0
Low temperature storage	Temp: -40°C 1000hrs		n=22,c=0
High temperature High humidity	Ta: 85°C, RH:85% 1000hrs		n=22,c=0
Solder heat	Temp: 260± 5°C 5sec 4mm From the bottom of the package.		n=22,c=0
Solderability	Temp: 230± 5°C 5sec 4mm From the bottom of the package.		More than 90% of Lead to be covered by soldering



Infrared Remote-control Receiver Module

MODEL NO : IRM-8752-2

■ Packing Specifications

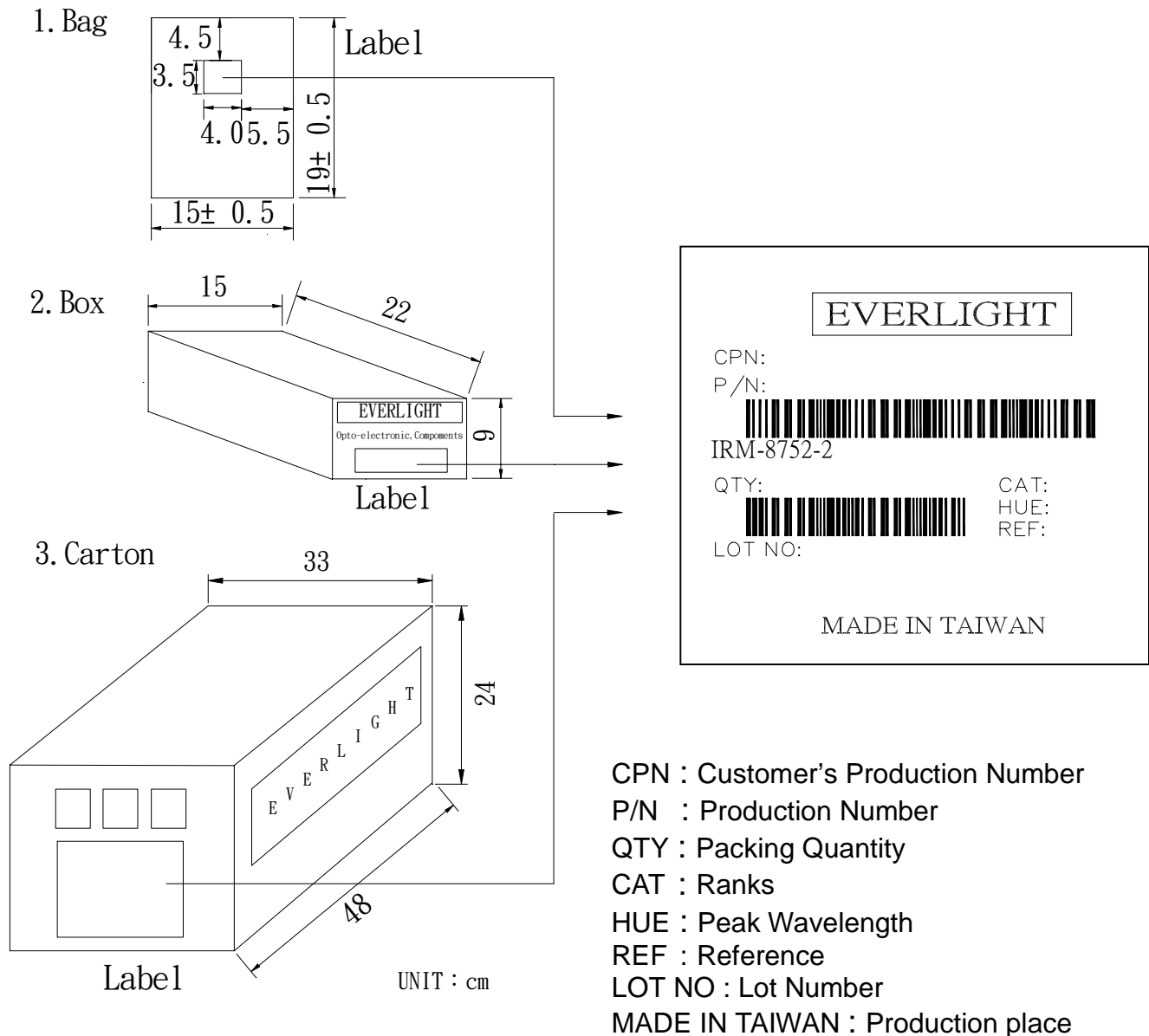

■ Packing Quantity Specification

1. 250 Pcs/1Bag , 6 Bags/1Box
2. 10 Boxes/1Carton