

**NPN Silicon AF Transistors**

- For AF input stages and driver applications
- High current gain
- Low collector-emitter saturation voltage
- Low noise between 30 Hz and 15 kHz
- Complementary types: BCW61, BCX71 (PNP)

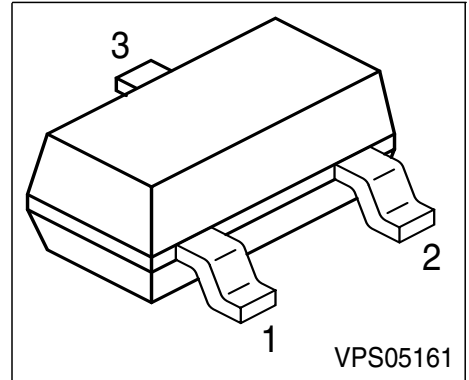

Type	Marking	Pin Configuration			Package
		1 = B	2 = E	3 = C	
BCW60A	AAs	1 = B	2 = E	3 = C	SOT23
BCW60B	ABs	1 = B	2 = E	3 = C	SOT23
BCW60C	ACs	1 = B	2 = E	3 = C	SOT23
BCW60D	ADs	1 = B	2 = E	3 = C	SOT23
BCW60FF	AFs	1 = B	2 = E	3 = C	SOT23
BCW60FN	ANs	1 = B	2 = E	3 = C	SOT23
BCX70G	AGs	1 = B	2 = E	3 = C	SOT23
BCX70H	AHs	1 = B	2 = E	3 = C	SOT23
BCX70J	AJs	1 = B	2 = E	3 = C	SOT23
BCX70K	AKs	1 = B	2 = E	3 = C	SOT23

**Maximum Ratings**

Parameter	Symbol	BCW60	BCW60FF	BCX70	Unit
Collector-emitter voltage	$V_{CEO}$	32	32	45	V
Collector-base voltage	$V_{CBO}$	32	32	45	
Emitter-base voltage	$V_{EBO}$	5	5	5	
DC collector current	$I_C$	100			mA
Peak collector current	$I_{CM}$	200			
Peak base current	$I_{BM}$	200			
Total power dissipation, $T_S = 71\text{ °C}$	$P_{tot}$	330			mW
Junction temperature	$T_j$	150			°C
Storage temperature	$T_{stg}$	-65 ... 150			

**Thermal Resistance**

Junction - soldering point <sup>1)</sup>	$R_{thJS}$	≤240	K/W
--	------------	------	-----

**Electrical Characteristics at  $T_A = 25\text{ °C}$ , unless otherwise specified.**

Parameter	Symbol	Values			Unit
		min.	typ.	max.	

**DC Characteristics**

Collector-emitter breakdown voltage $I_C = 10\text{ mA}$ , $I_B = 0$	$V_{(BR)CEO}$	<b>BCW60/60FF</b>	32	-	-	V
<b>BCX70</b>		45	-	-		
Collector-base breakdown voltage $I_C = 10\text{ }\mu\text{A}$ , $I_B = 0$	$V_{(BR)CBO}$	<b>BCW60/60FF</b>	32	-	-	
<b>BCX70</b>		45	-	-		
Emitter-base breakdown voltage $I_E = 1\text{ }\mu\text{A}$ , $I_C = 0$	$V_{(BR)EBO}$		5	-	-	

<sup>1</sup>For calculation of  $R_{thJA}$  please refer to Application Note Thermal Resistance

**Electrical Characteristics** at  $T_A = 25^\circ\text{C}$ , unless otherwise specified.

Parameter	Symbol	Values			Unit
		min.	typ.	max.	
<b>AC Characteristics</b>					
Collector cutoff current $V_{CB} = 32\text{ V}, I_E = 0$ $V_{CB} = 45\text{ V}, I_E = 0$	$I_{CBO}$	-	-	20	nA
	<b>BCW60 /60FF</b>	-	-	20	
	<b>BCX70</b>	-	-	20	
Collector cutoff current $V_{CB} = 32\text{ V}, I_E = 0, T_A = 150^\circ\text{C}$ $V_{CB} = 45\text{ V}, I_E = 0, T_A = 150^\circ\text{C}$	$I_{CBO}$	-	-	20	$\mu\text{A}$
	<b>BCW60 / 60FF</b>	-	-	20	
	<b>BCX70</b>	-	-	20	
Emitter cutoff current $V_{EB} = 4\text{ V}, I_C = 0$	$I_{EBO}$	-	-	20	nA
DC current gain 1) $I_C = 10\ \mu\text{A}, V_{CE} = 5\text{ V}$	$h_{FE}$	20	140	-	-
	$h_{FE}$ -grp. <b>A/ G</b>	20	140	-	
	$h_{FE}$ -grp. <b>B/ H</b>	20	200	-	
	$h_{FE}$ -grp. <b>C/ J/ FF</b>	40	300	-	
	$h_{FE}$ -grp. <b>D/ K/ FN</b>	100	460	-	
DC current gain 1) $I_C = 2\text{ mA}, V_{CE} = 5\text{ V}$	$h_{FE}$	120	170	220	
	$h_{FE}$ -grp. <b>A/ G</b>	120	170	220	
	$h_{FE}$ -grp. <b>B/ H</b>	180	250	310	
	$h_{FE}$ -grp. <b>C/ J/ FF</b>	250	350	460	
	$h_{FE}$ -grp. <b>D/ K/ FN</b>	380	500	630	
DC current gain 1) $I_C = 50\text{ mA}, V_{CE} = 1\text{ V}$	$h_{FE}$	50	-	-	
	$h_{FE}$ -grp. <b>A/ G</b>	50	-	-	
	$h_{FE}$ -grp. <b>B/ H</b>	70	-	-	
	$h_{FE}$ -grp. <b>C/ J/ FF</b>	90	-	-	
	$h_{FE}$ -grp. <b>D/ K/ FN</b>	100	-	-	

1) Pulse test:  $t \leq 300\ \mu\text{s}$ ,  $D = 2\%$

**Electrical Characteristics** at  $T_A = 25^\circ\text{C}$ , unless otherwise specified.

Parameter	Symbol	Values			Unit
		min.	typ.	max.	
<b>DC Characteristics</b>					
Collector-emitter saturation voltage <sup>1)</sup> $I_C = 10\text{ mA}, I_B = 0.25\text{ mA}$ $I_C = 50\text{ mA}, I_B = 1.25\text{ mA}$	$V_{CEsat}$	-	0.12 0.2	0.25 0.55	V
Base-emitter saturation voltage 1) $I_C = 10\text{ mA}, I_B = 0.25\text{ mA}$ $I_C = 50\text{ mA}, I_B = 1.25\text{ mA}$	$V_{BEsat}$	-	0.7 0.83	0.85 1.05	
Base-emitter voltage 1) $I_C = 10\text{ }\mu\text{A}, V_{CE} = 5\text{ V}$ $I_C = 2\text{ mA}, V_{CE} = 5\text{ V}$ $I_C = 50\text{ mA}, V_{CE} = 1\text{ V}$	$V_{BE(ON)}$	- 0.55 -	0.52 0.65 0.78	- 0.75 -	
<b>AC Characteristics</b>					
Transition frequency $I_C = 20\text{ mA}, V_{CE} = 5\text{ V}, f = 100\text{ MHz}$	$f_T$	-	250	-	MHz
Collector-base capacitance $V_{CB} = 10\text{ V}, f = 1\text{ MHz}$	$C_{cb}$	-	3	-	pF
Emitter-base capacitance $V_{EB} = 0.5\text{ V}, f = 1\text{ MHz}$	$C_{eb}$	-	8	-	
Short-circuit input impedance $I_C = 2\text{ mA}, V_{CE} = 5\text{ V}, f = 1\text{ kHz}$	$h_{FE-grp.}$ <b>A / G</b> <b>B / H</b> <b>C / J / FF</b> <b>D / K / FN</b>	$h_{11e}$	- 2.7 3.6 4.5 7.5	- - - -	k $\Omega$
Open-circuit reverse voltage transf.ratio $I_C = 2\text{ mA}, V_{CE} = 5\text{ V}, f = 1\text{ kHz}$	$h_{FE-grp.}$ <b>A / G</b> <b>B / H</b> <b>C / J/FF</b> <b>D / K / FN</b>	$h_{12e}$	- 1.5 2 2 3	- - - -	$10^{-4}$

 1) Pulse test:  $t \leq 300\mu\text{s}$ ,  $D = 2\%$

**Electrical Characteristics** at  $T_A = 25^\circ\text{C}$ , unless otherwise specified.

Parameter	Symbol	Values			Unit
		min.	typ.	max.	
<b>AC Characteristics</b>					
Short-circuit forward current transf. ratio   $h_{FE-grp.}$ $I_C = 2\text{ mA}, V_{CE} = 5\text{ V}, f = 1\text{ kHz}$	$h_{21e}$				-
<b>A / G</b>		-	200	-	
<b>B / H</b>		-	260	-	
<b>C / J / FF</b>		-	330	-	
<b>D / K / FN</b>		-	520	-	
Open-circuit output admittance $I_C = 2\text{ mA}, V_{CE} = 5\text{ V}, f = 1\text{ kHz}$	$h_{FE-grp.}$ $h_{22e}$				$\mu\text{S}$
<b>A / G</b>		-	18	-	
<b>B / H</b>		-	24	-	
<b>C / J / FF</b>		-	30	-	
<b>D / K / FN</b>		-	50	-	
Noise figure $I_C = 100\text{ }\mu\text{A}, V_{CE} = 5\text{ V}, R_S = 1\text{ k}\Omega,$ $f = 1\text{ kHz}, \Delta f = 200\text{ Hz}$	$h_{FE-grp.}$ $F$				dB
<b>A - K</b>		-	2	-	
<b>FF - FN</b>		-	1	2	
Equivalent noise voltage $I_C = 200\text{ }\mu\text{A}, V_{CE} = 5\text{ V}, R_S = 2\text{ k}\Omega,$ $f = 10 \dots 50\text{ Hz}$	$h_{FE-grp.}$ $V_n$	-	-	0.135	$\mu\text{V}$
<b>FF / FN</b>					

**Total power dissipation  $P_{tot} = f(T_S)$**

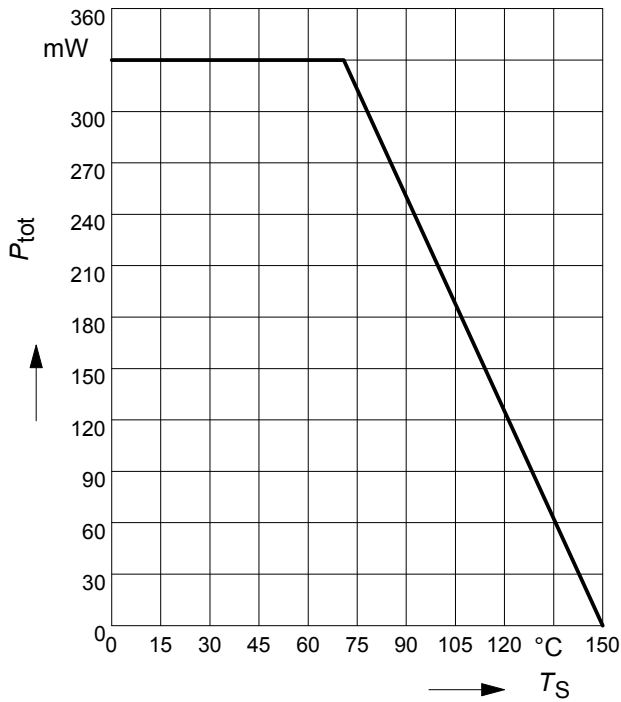

**Collector-base capacitance  $C_{CB} = f(V_{CBO})$   
Emitter-base capacitance  $C_{EB} = f(V_{EBO})$**

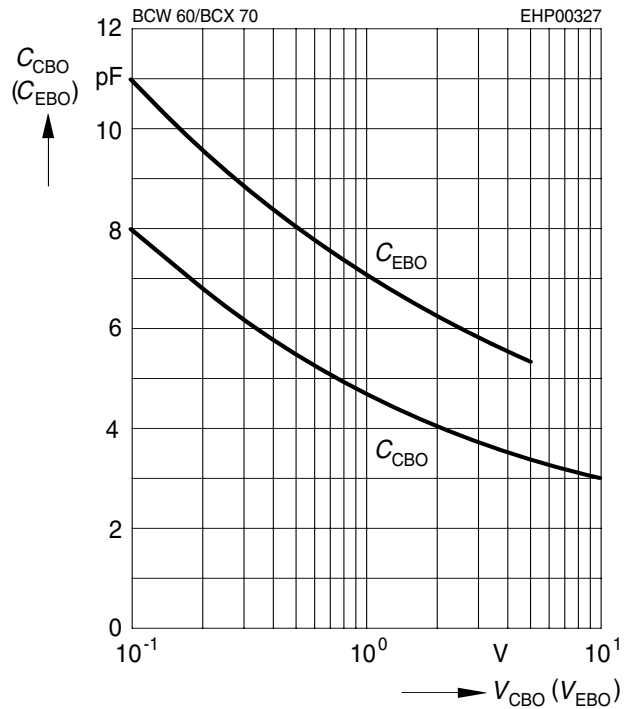

**Permissible pulse load**

$P_{totmax} / P_{totDC} = f(t_p)$

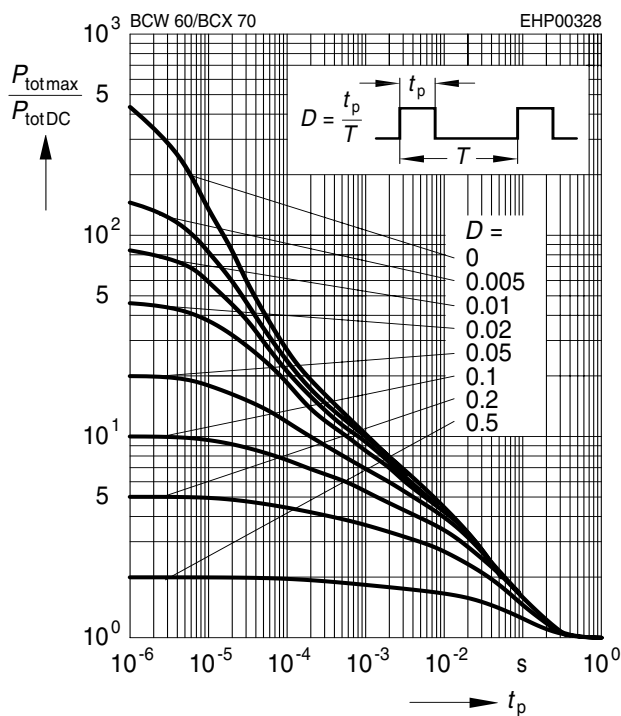

**Transition frequency  $f_T = f(I_C)$**

$V_{CE} = 5V$

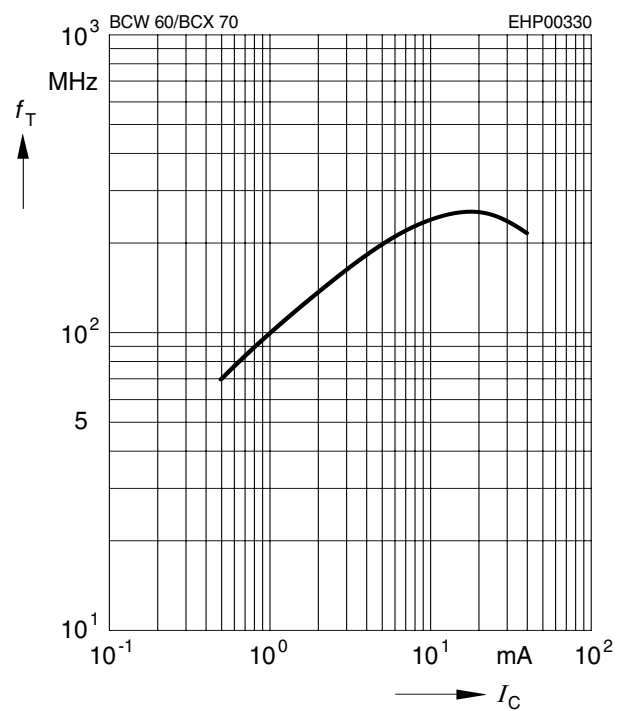

**Base-emitter saturation voltage**

$I_C = f(V_{BEsat}), h_{FE} = 40$

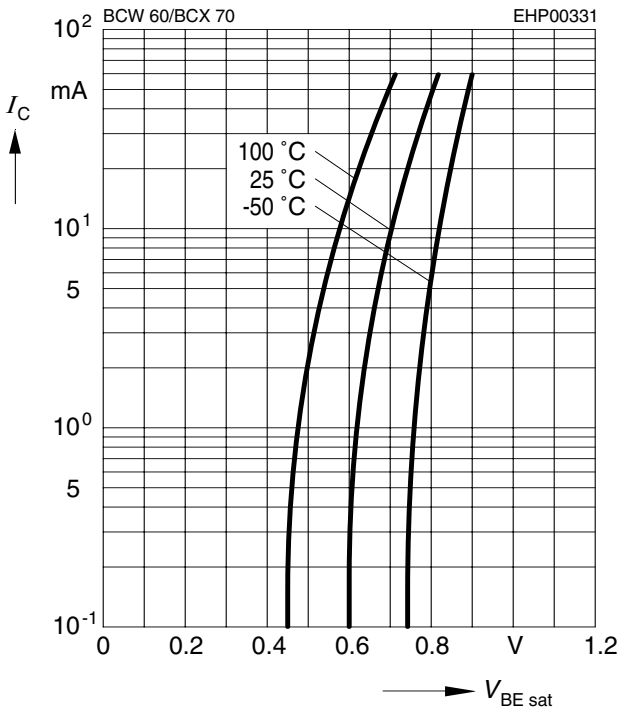

**Collector-emitter saturation voltage**

$I_C = f(V_{CEsat}), h_{FE} = 40$

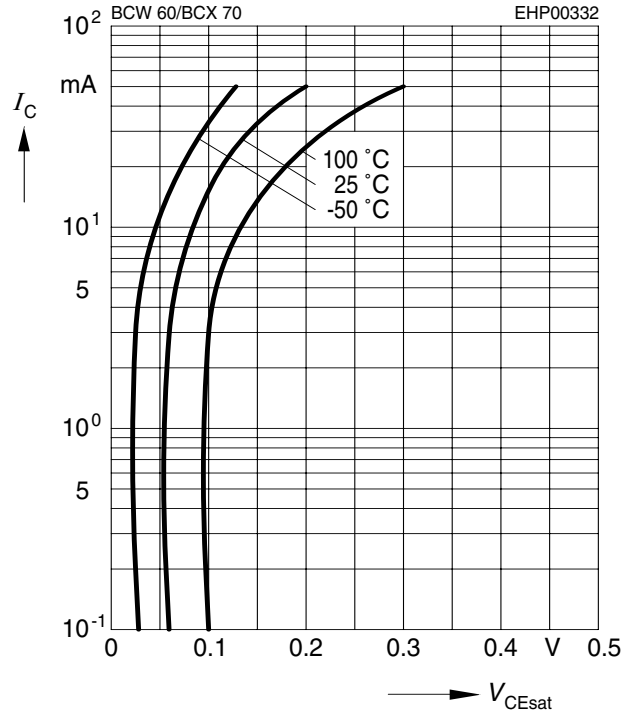

**Collector current  $I_C = f(V_{BE})$**

$V_{CE} = 5V$

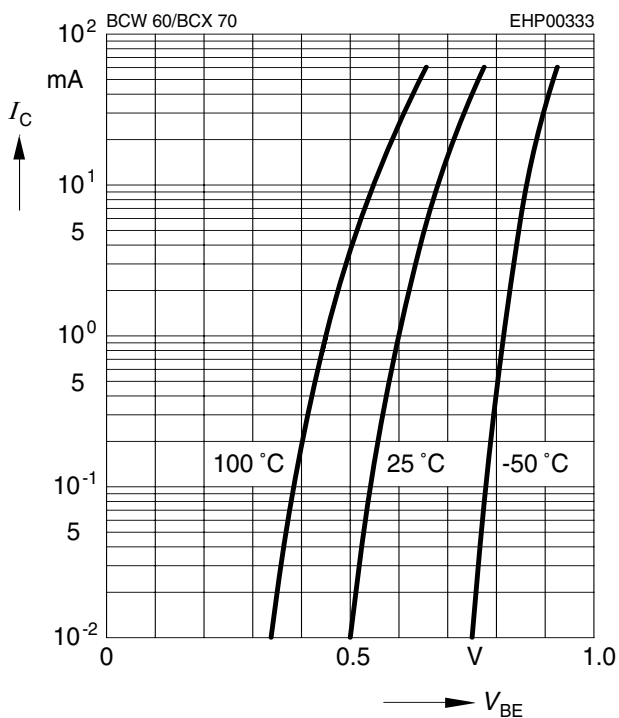

**DC current gain  $h_{FE} = f(I_C)$**

$V_{CE} = 5V$

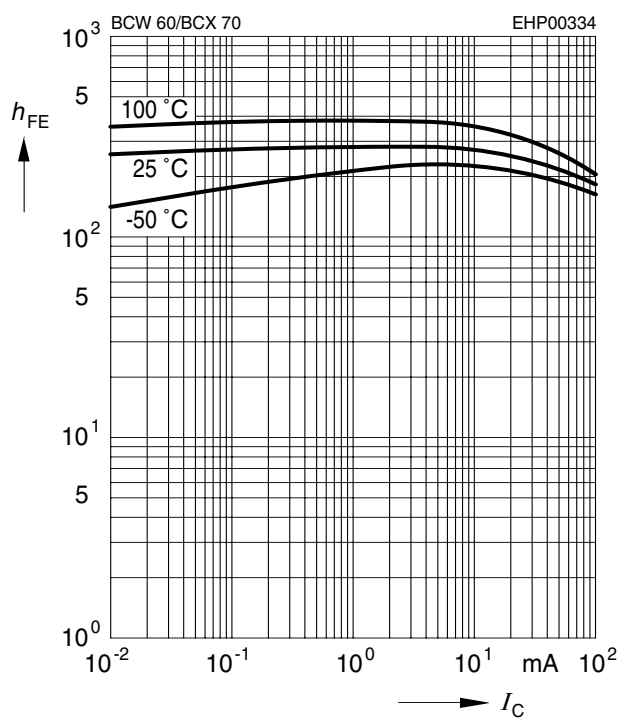

**Collector cutoff current  $I_{CBO} = f(T_A)$**

$V_{CB} = V_{CEmax}$

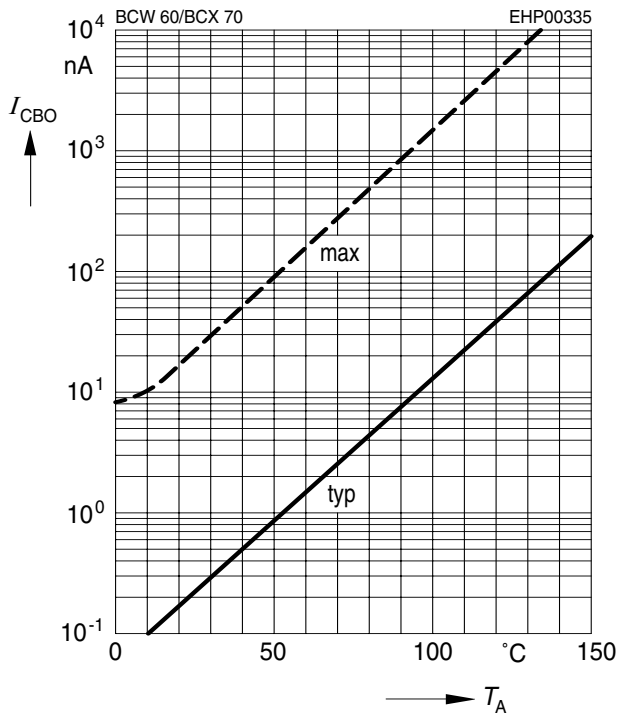

**h parameter  $h_e = f(I_C)$  normalized**

$V_{CE} = 5V$

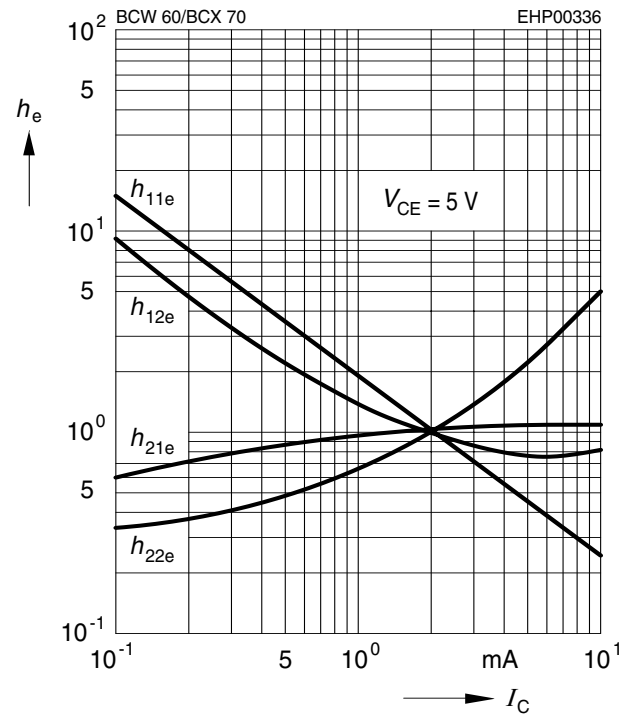

**h parameter  $h_e = f(V_{CE})$  normalized**

$I_C = 2mA$

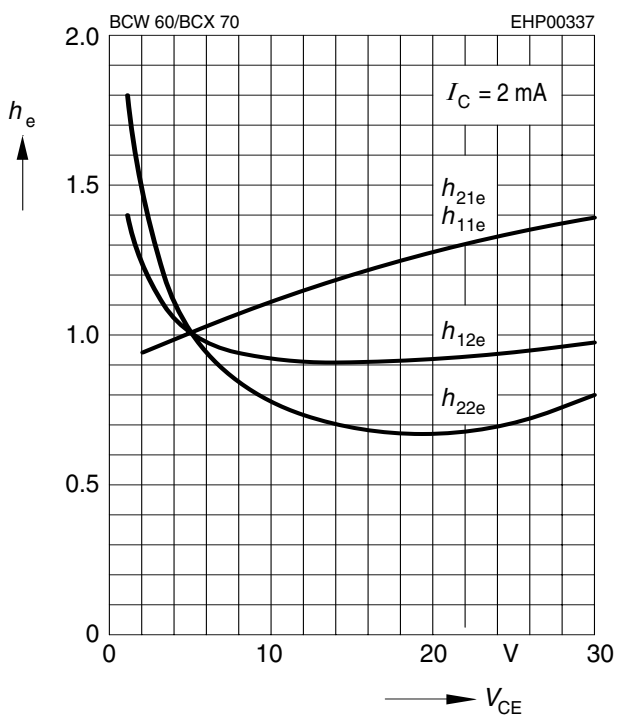

**Noise figure  $F = f(V_{CE})$**

$I_C = 0.2mA, R_S = 2k\Omega, f = 1kHz$

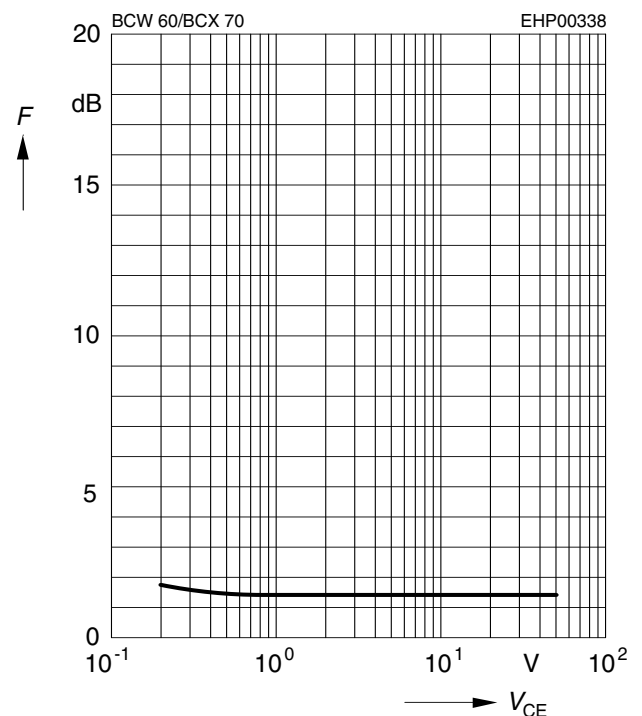



**Noise figure  $F = f(f)$**

$I_C = 0.2\text{mA}$ ,  $V_{CE} = 5\text{V}$ ,  $R_S = 2\text{k}\Omega$

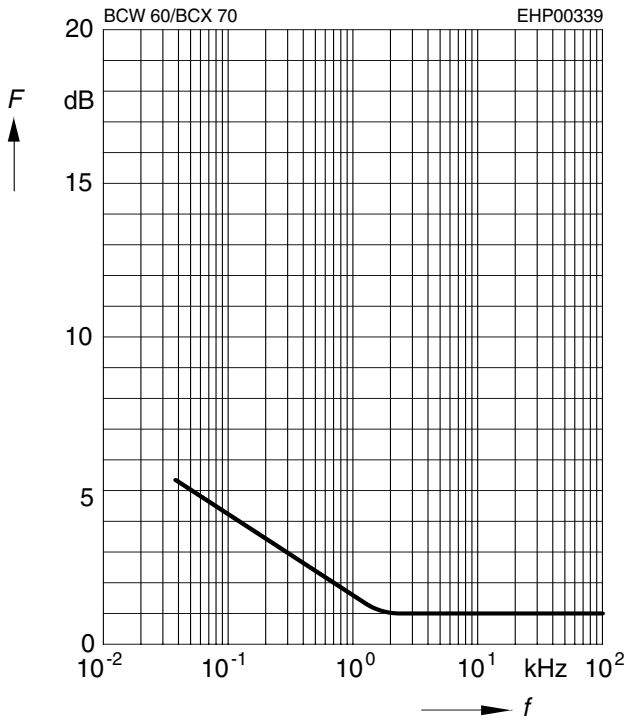

**Noise figure  $F = f(I_C)$**

$V_{CE} = 5\text{V}$ ,  $f = 120\text{Hz}$

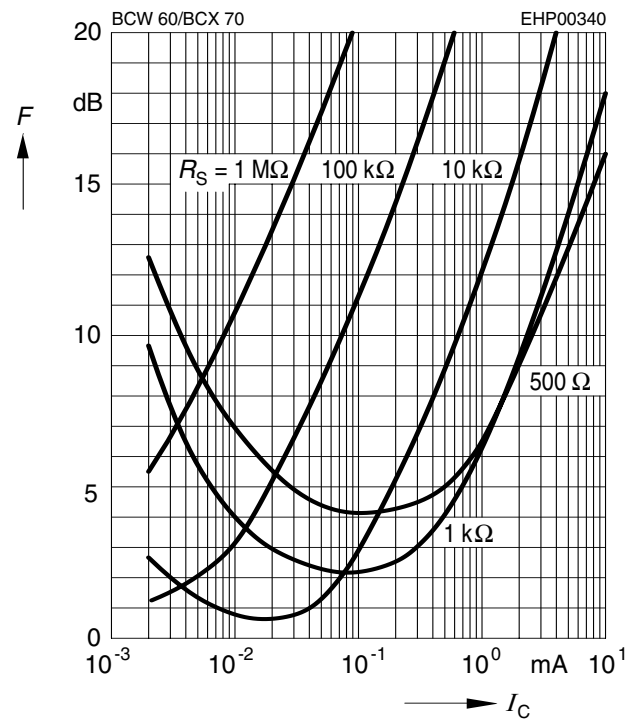

**Noise figure  $F = f(I_C)$**

$V_{CE} = 5\text{V}$ ,  $f = 1\text{kHz}$

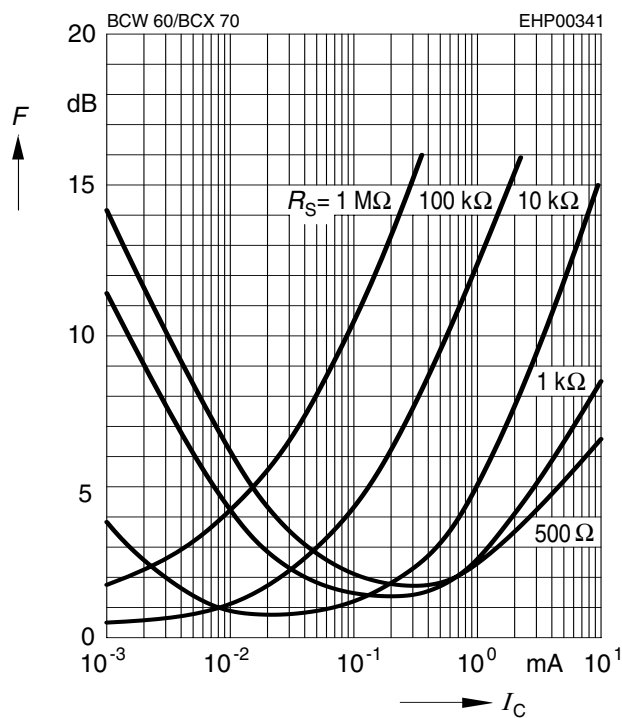

**Noise figure  $F = f(I_C)$**

$V_{CE} = 5\text{V}$ ,  $f = 10\text{kHz}$

