

**PNP Silicon Darlington Transistors**

- High collector current
- High DC current gain

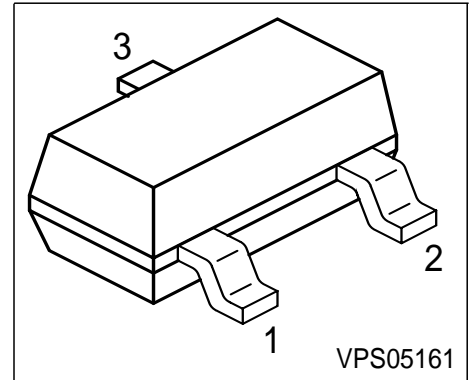

Type	Marking	Pin Configuration			Package
SMBTA63	s2U	1 = B	2 = E	3 = C	SOT23
SMBTA64	s2V	1 = B	2 = E	3 = C	SOT23

**Maximum Ratings**

Parameter	Symbol	Value	Unit
Collector-emitter voltage	$V_{CES}$	30	V
Collector-base voltage	$V_{CBO}$	30	
Emitter-base voltage	$V_{EBO}$	10	
DC collector current	$I_C$	500	mA
Peak collector current	$I_{CM}$	800	A
Base current	$I_B$	100	mA
Peak base current	$I_{BM}$	200	
Total power dissipation, $T_S = 81\text{ °C}$	$P_{tot}$	330	mW
Junction temperature	$T_j$	150	°C
Storage temperature	$T_{stg}$	-65 ... 150	

**Thermal Resistance**

Junction - soldering point <sup>1)</sup>	$R_{thJS}$	≤210	K/W
--	------------	------	-----

<sup>1)</sup>For calculation of  $R_{thJA}$  please refer to Application Note Thermal Resistance

**Electrical Characteristics** at  $T_A = 25^\circ\text{C}$ , unless otherwise specified.

Parameter	Symbol	Values			Unit
		min.	typ.	max.	
<b>DC Characteristics</b>					
Collector-emitter breakdown voltage $I_C = 10 \mu\text{A}, V_{BE} = 0$	$V_{(BR)CES}$	30	-	-	V
Collector-base breakdown voltage $I_C = 10 \mu\text{A}, I_E = 0$	$V_{(BR)CBO}$	30	-	-	
Emitter-base breakdown voltage $I_E = 10 \mu\text{A}, I_C = 0$	$V_{(BR)EBO}$	10	-	-	
Collector cutoff current $V_{CB} = 30 \text{ V}, I_E = 0$	$I_{CBO}$	-	-	100	nA
Collector cutoff current $V_{CB} = 30 \text{ V}, I_E = 0, T_A = 150^\circ\text{C}$	$I_{CBO}$	-	-	10	$\mu\text{A}$
Emitter cutoff current $V_{EB} = 10 \text{ V}, I_C = 0$	$I_{EBO}$	-	-	100	nA
DC current gain 1) $I_C = 10 \text{ mA}, V_{CE} = 5 \text{ V}$ $I_C = 100 \text{ mA}, V_{CE} = 5 \text{ V}$	$h_{FE}$				-
	SMBTA63	5000	-	-	
	SMBTA64	10000	-	-	
	SMBTA63	10000	-	-	
	SMBTA64	20000	-	-	
Collector-emitter saturation voltage1) $I_C = 100 \text{ mA}, I_B = 0.1 \text{ mA}$	$V_{CEsat}$	-	-	1.5	V
Base-emitter saturation voltage 1) $I_C = 100 \text{ mA}, I_B = 0.1 \text{ mA}$	$V_{BEsat}$	-	-	2	
<b>AC Characteristics</b>					
Transition frequency $I_C = 50 \text{ mA}, V_{CE} = 5 \text{ V}, f = 20 \text{ MHz}$	$f_T$	125	-	-	MHz

 1) Pulse test:  $t \leq 300 \mu\text{s}$ ,  $D = 2\%$

**Total power dissipation  $P_{tot} = f(T_S)$**

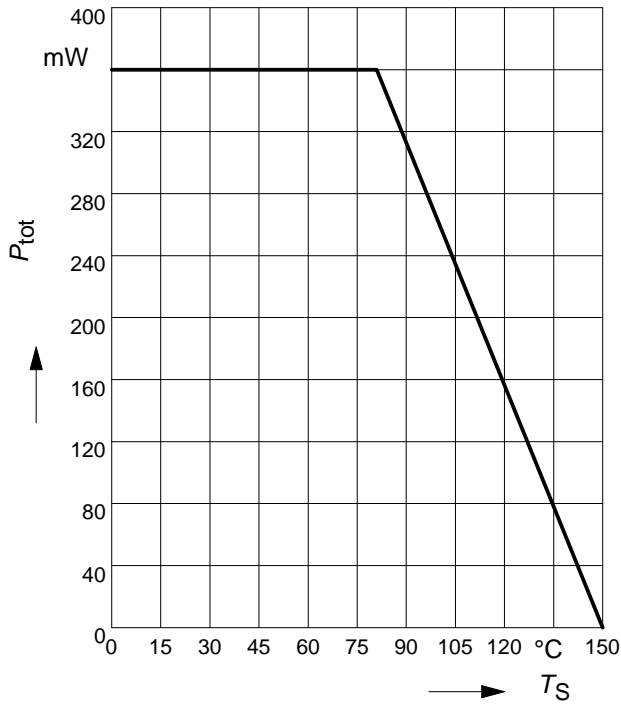

**Collector-base capacitance  $C_{CB} = f(V_{CB0})$   
Emitter-base capacitance  $C_{EB} = f(V_{EB0})$**

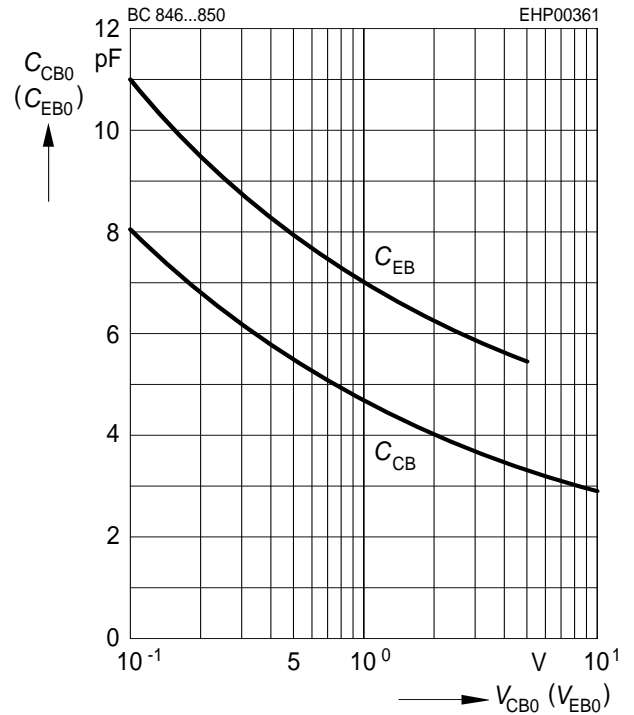

**Permissible pulse load**

$P_{totmax} / P_{totDC} = f(t_p)$

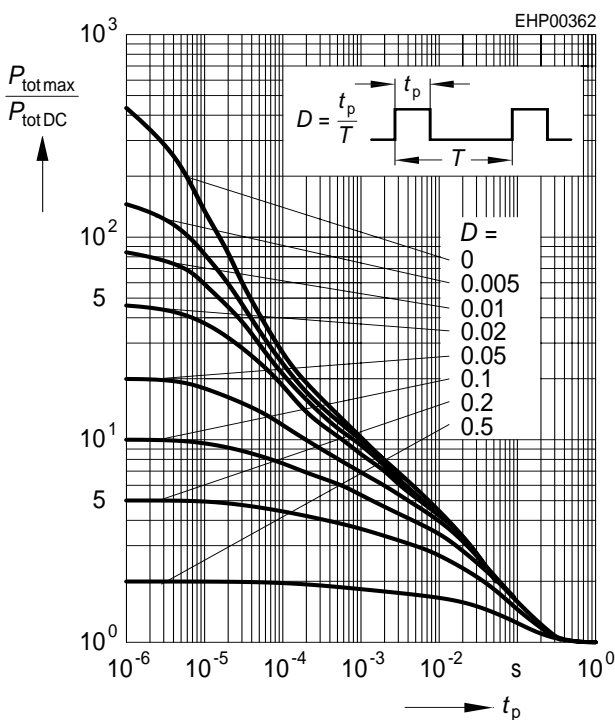

**Transition frequency  $f_T = f(I_C)$**

$V_{CE} = 5V$

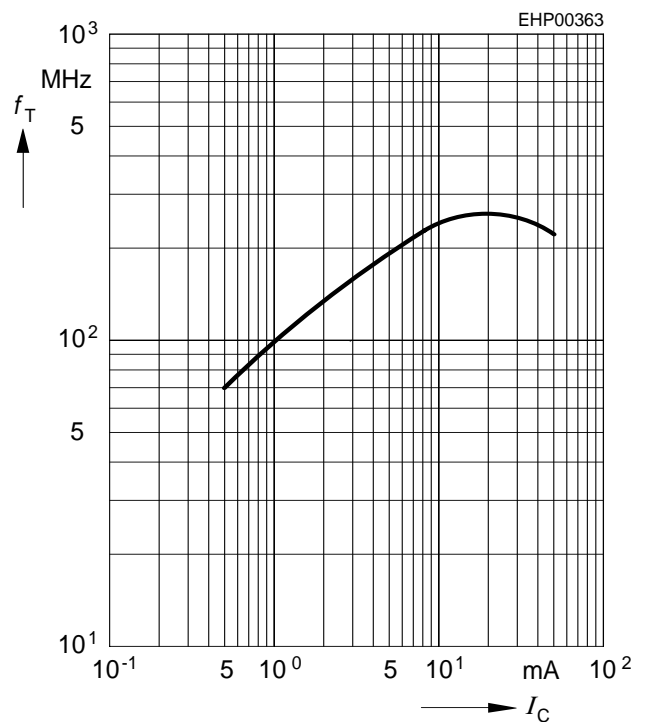

**Base-emitter saturation voltage**

$I_C = f(V_{BEsat}), h_{FE} = 20$

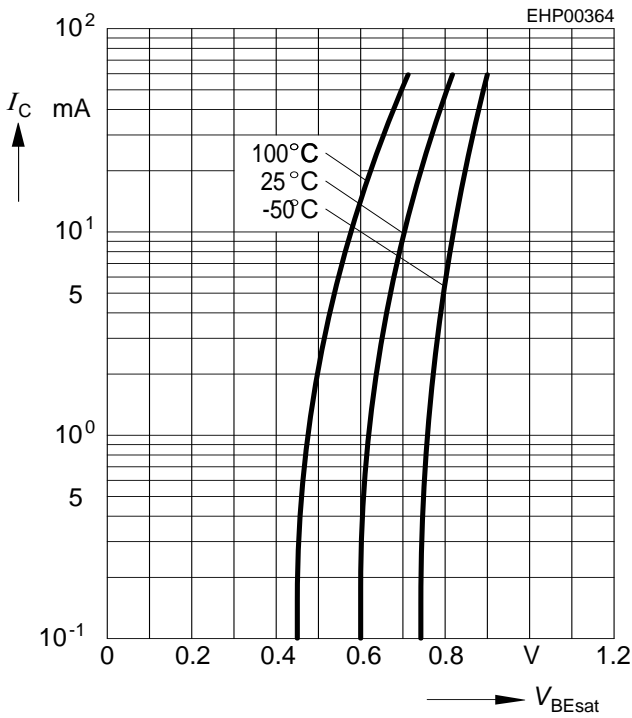

**Collector-emitter saturation voltage**

$I_C = f(V_{CEsat}), h_{FE} = 20$

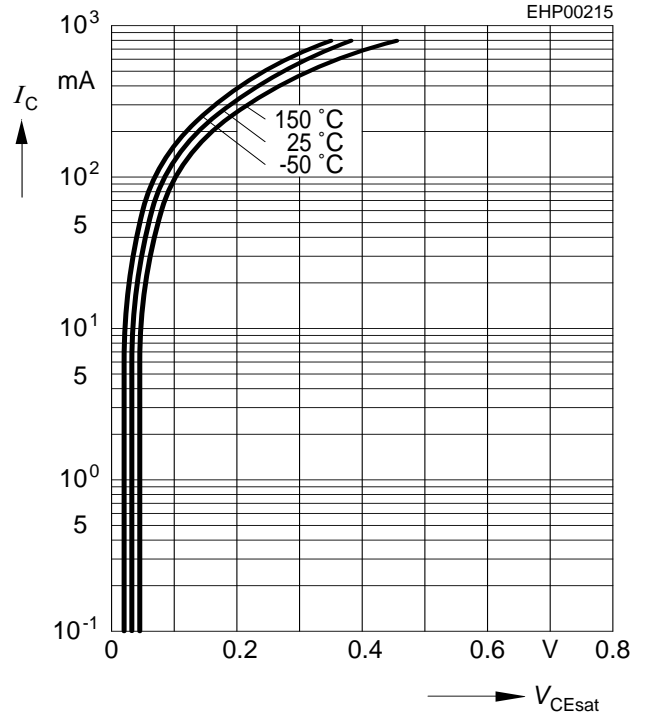

**Collector cutoff current  $I_{CBO} = f(T_A)$**

$V_{CB} = 30V$

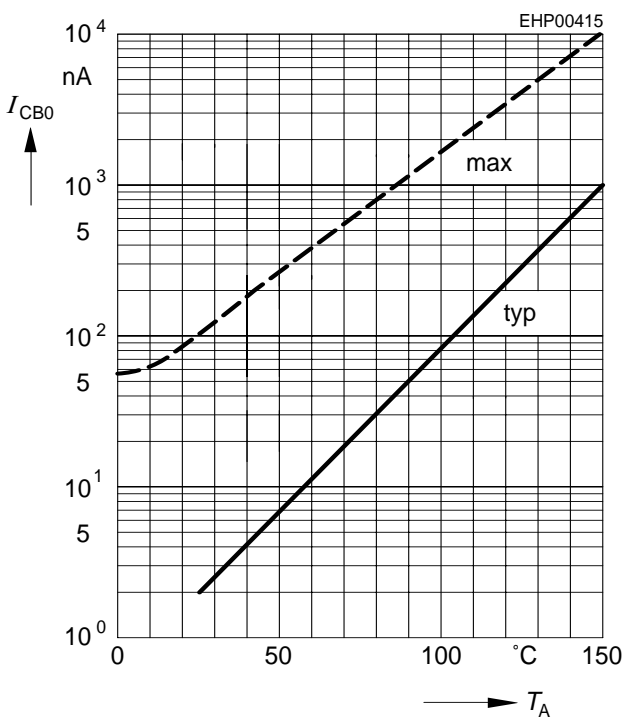

**DC current gain  $h_{FE} = f(I_C)$**

$V_{CE} = 5V$

