

Features

- Output tracking tolerance $\leq \pm 0.5\%$
- 50 mA output current
- Combined Tracking/Enable input
- Very low current consumption in off mode
- Low drop voltage
- Suitable for use in automotive electronics
- Wide operation range: up to 40 V
- Wide temperature range: $-40\text{ }^{\circ}\text{C} \leq T_j \leq 150\text{ }^{\circ}\text{C}$
- Output protected against short circuit
- Overtemperature protection
- Reverse polarity proof
- Very small SMD-Package SCT 595

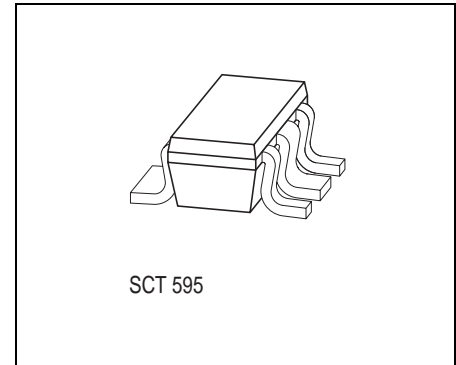

Type	Ordering Code	Package
TLE 4250 G	Q67006-A9351	SCT-595 (SMD)

Functional Description

The TLE 4250 G is a monolithic integrated low-drop voltage tracker in the very small SMD package SCT 595. It is designed to supply e.g. sensors under the severe conditions of automotive applications. Therefore the device is equipped with additional protection functions against overload, short circuit and reverse polarity.

Supply voltages up to 40 V are tracked to a reference voltage at the adjust input. Therefore the Adjust pin has to be connected to a reference voltage, e.g. to a 5 V supply on a micro-controller port.

The output is able to drive a load up to 50 mA while it follows the output of a main voltage regulator within an accuracy of 0.5%.

The TLE 4250 G can be switched in stand-by mode via the adjust input which causes the current consumption to drop to very low values. This feature makes the IC suitable for low power battery applications.

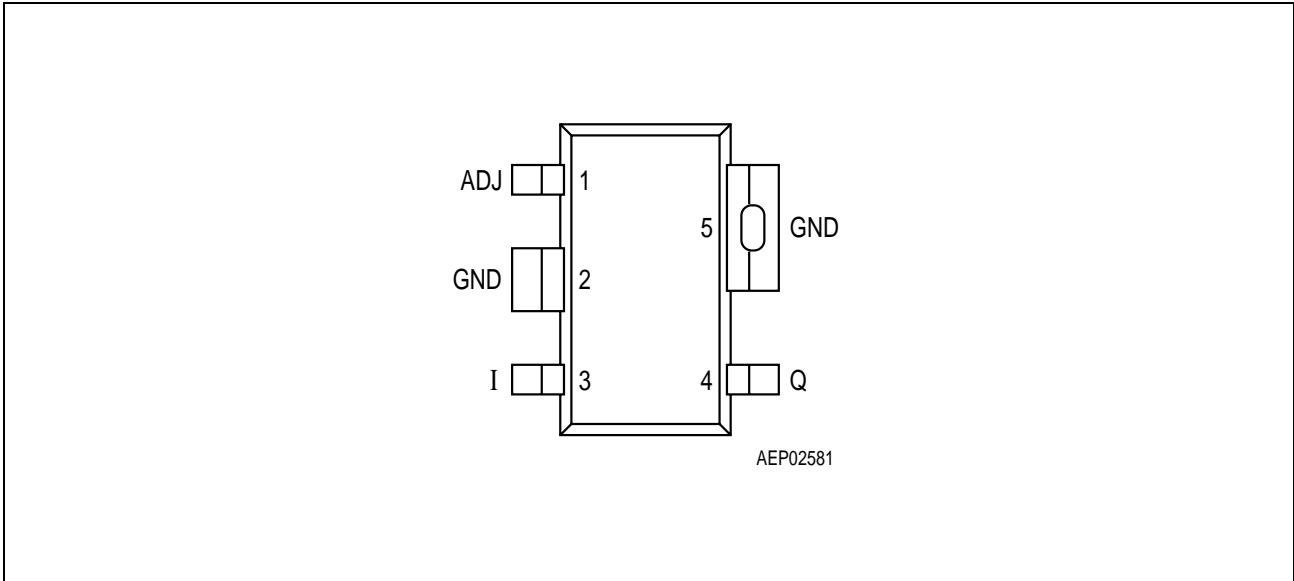

Figure 1 Pin Configuration (top view)

Pin Definitions and Functions

Pin No.	Symbol	Function
1	ADJ	Adjust/Enable input ; connect to the reference voltage via ext. resistor or micro-controller port; high active input
2	GND	Ground ; internally connected to pin 5
3	I	Input voltage
4	Q	Output voltage ; must be blocked by a capacitor $C_Q \geq 1 \mu\text{F}$, $2 \Omega \leq \text{ESR} \leq 7 \Omega$
5	GND	Ground

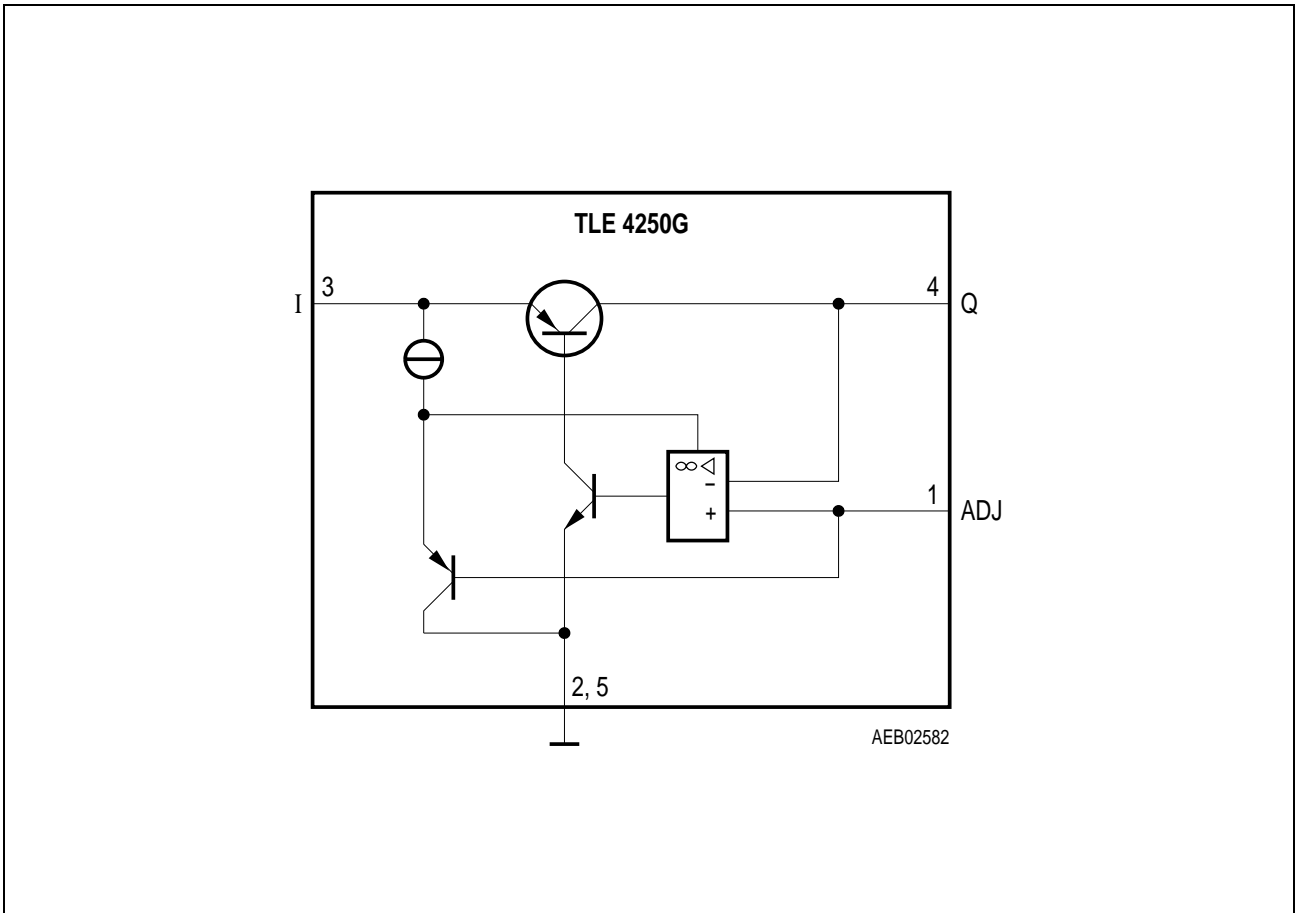

Figure 2 **Block Diagram**

Absolute Maximum Ratings
 $-40\text{ °C} < T_j < 150\text{ °C}$

Parameter	Symbol	Limit Values		Unit	Remarks
		min.	max.		

Input

Voltage	V_I	- 42	45	V	-
Current	I_I	-	-	mA	internally limited

Output

Voltage	V_Q	- 1	40	V	-
Current	I_Q	-	-	mA	internally limited

Adjust

Voltage	V_{ADJ}	- 0.3	40	V	-
Current	I_{ADJ}	-	-	μ A	internally limited

Temperatures

Junction temperature	T_j	- 40	150	°C	-
Storage temperature	T_{stg}	- 50	150	°C	-

Thermal Resistances

Junction pin	$R_{thj-pin}$	-	30	K/W	measured to pin 5
Junction ambient	R_{thja}	-	99	K/W	¹⁾

¹⁾ Worst case, regarding peak temperature; zero airflow; mounted on a PCB 80 × 80 × 1.5 mm³, heat sink area 300 mm².

Note: Maximum ratings are absolute ratings; exceeding any one of these values may cause irreversible damage to the integrated circuit.

Operating Range

Parameter	Symbol	Limit Values		Unit	Remarks
		min.	max.		
Input voltage	V_I	4	40	V	–
Adjust input voltage	V_{ADJ}	2.5	36	V	–
Junction temperature	T_j	– 40	150	°C	–

Electrical Characteristics
 $V_I = 13.5\text{ V}; V_{\text{ADJ}} > 2.5\text{ V}; -40\text{ }^\circ\text{C} < T_j < 150\text{ }^\circ\text{C};$ unless otherwise specified

Parameter	Symbol	Limit Values			Unit	Test Condition
		min.	typ.	max.		

Output

Output voltage tracking accuracy $\Delta V_Q = V_{\text{ADJ}} - V_Q$	ΔV_Q	- 25	-	25	mV	$6\text{ V} < V_I < 28\text{ V}$ $1\text{ mA} < I_Q < 50\text{ mA}$
Output voltage tracking accuracy	ΔV_Q	- 25	-	25	mV	$6\text{ V} < V_I < 40\text{ V}$ $1\text{ mA} < I_Q < 10\text{ mA}$
Output voltage tracking accuracy	ΔV_Q	- 5	-	5	mV	$6\text{ V} < V_I < 16\text{ V}$ $1\text{ mA} < I_Q < 10\text{ mA}$
Drop voltage	V_{dr}	-	100	300	mV	$I_Q = 10\text{ mA};$ $V_{\text{ADJ}} > 4\text{ V}$ ¹⁾
Output current	I_Q	50	70	-	mA	¹⁾ $T_j < 125\text{ }^\circ\text{C}$
Output capacitor	C_Q	1	-	-	μF	at 10 kHz; $2\ \Omega \leq \text{ESR} \leq 7\ \Omega$
Current consumption $I_q = I_I - I_Q$	I_q	-	1.5	3.0	mA	$I_Q < 30\text{ mA}$
Current consumption $I_q = I_I - I_Q$	I_q	-	80	150	μA	$I_Q < 1\text{ mA}$
Quiescent current (stand-by) $I_q = I_I - I_Q$	I_q	-	10	20	μA	$V_{\text{ADJ}} = 0\text{ V}$ $T_j < 85\text{ }^\circ\text{C}$
Current consumption (drop area)	I_q	-	-	3	mA	$V_{\text{ADJ}} = V_I = 5\text{ V}$ $I_Q = 0\text{ mA}$
Load regulation	ΔV_Q	- 15	-	15	mV	$1\text{ mA} < I_Q < 30\text{ mA}$
Line regulation	ΔV_Q	- 10	-	10	mV	$6\text{ V} < V_I < 40\text{ V}$ $I_Q = 10\text{ mA}$

¹⁾ Measured when the output voltage V_Q has dropped 100 mV from the nominal value.

Electrical Characteristics (cont'd)
 $V_I = 13.5 \text{ V}; V_{ADJ} > 2.5 \text{ V}; -40 \text{ }^\circ\text{C} < T_j < 150 \text{ }^\circ\text{C};$ unless otherwise specified

Parameter	Symbol	Limit Values			Unit	Test Condition
		min.	typ.	max.		
Power-Supply-Ripple-Rejection	$PSRR$	–	60	–	dB	$f_r = 100 \text{ Hz}$ $V_r = 0.5 V_{PP}$

Adjust/Enable Input

Input biasing current	I_{ADJ}	–	0.1	0.5	μA	$V_{ADJ} = 5 \text{ V}$
Adjust low voltage to disable	V_{ADJ}	–	–	0.8	V	$T_j < 125 \text{ }^\circ\text{C}$ V_Q off
Adjust range	V_{ADJ}	2.0	–	36	V	$V_Q - V_{ADJ} < 25 \text{ mV}$ $T_j < 125 \text{ }^\circ\text{C}$

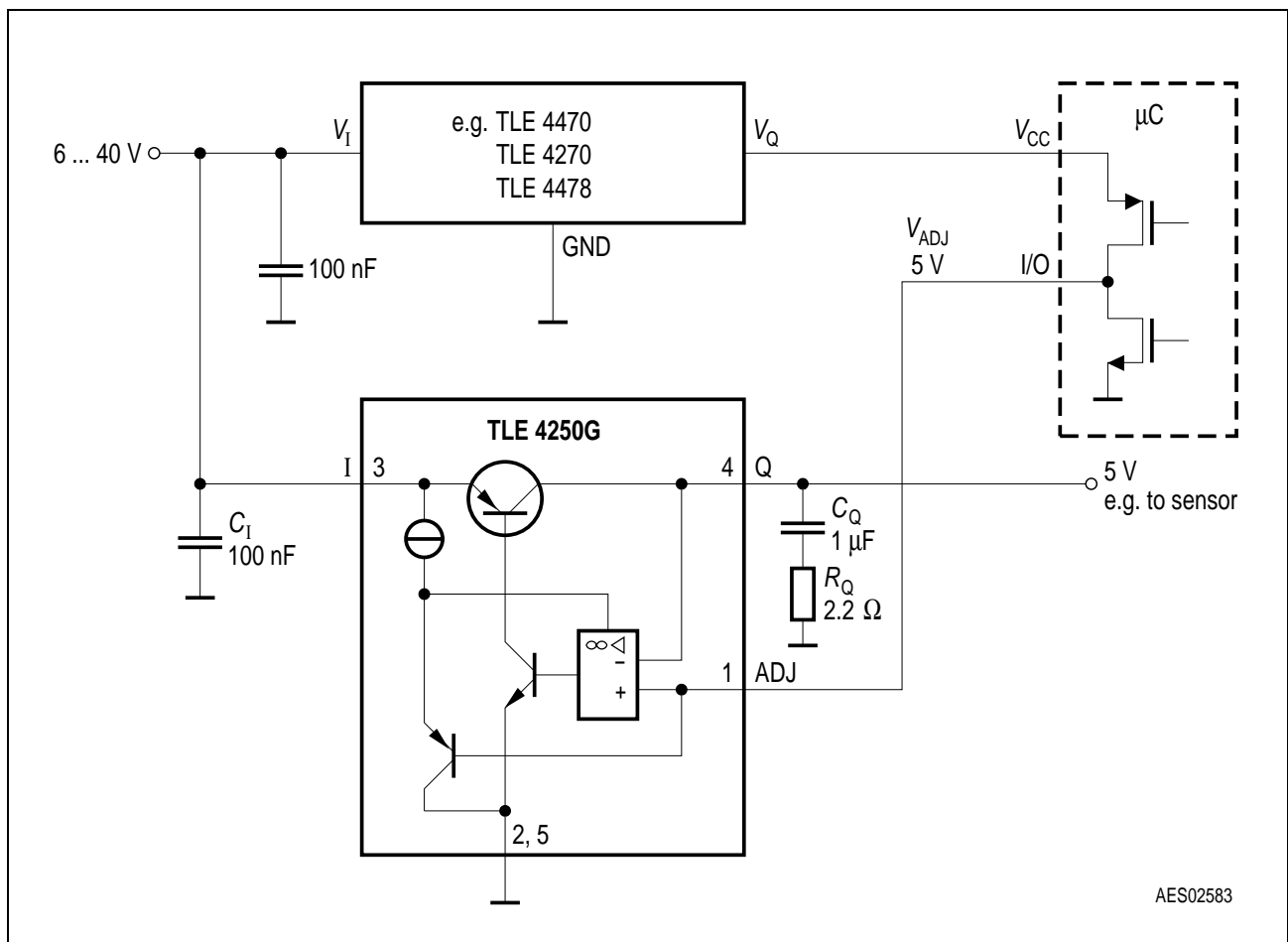
Figure 3 Application Circuit

**Region of Stability for
 $C_Q = 1 \mu\text{F}$**

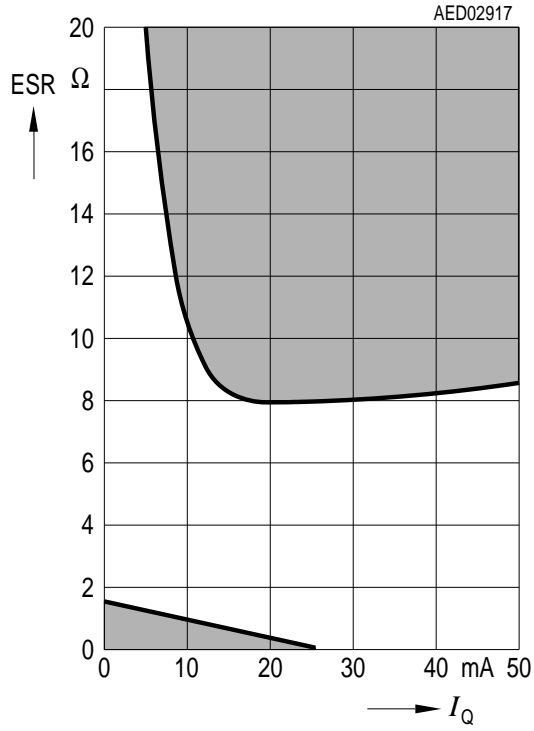

**Region of Stability for
 $C_Q = 2.2 \mu\text{F}$**

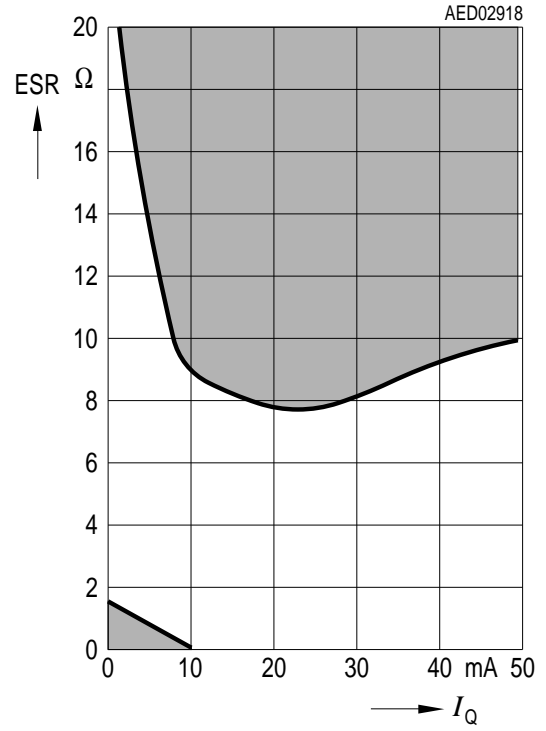

Typical Performance Characteristics

Tracking Accuracy ΔV_Q versus Temperature T_j

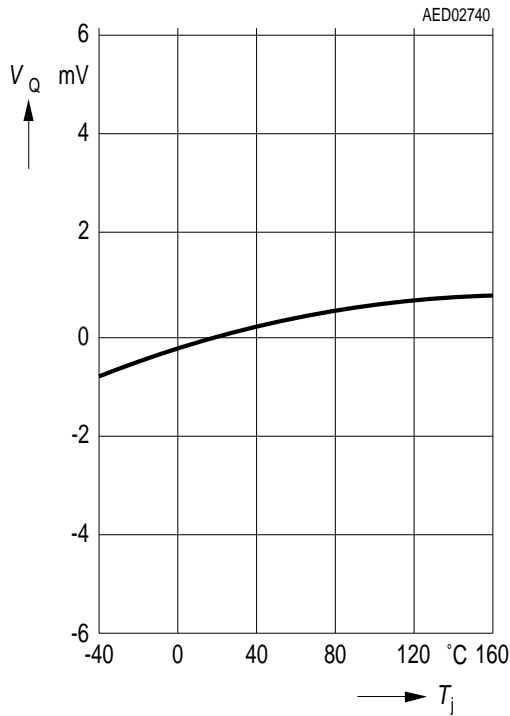

Tracking Accuracy ΔV_Q versus Output Current I_Q

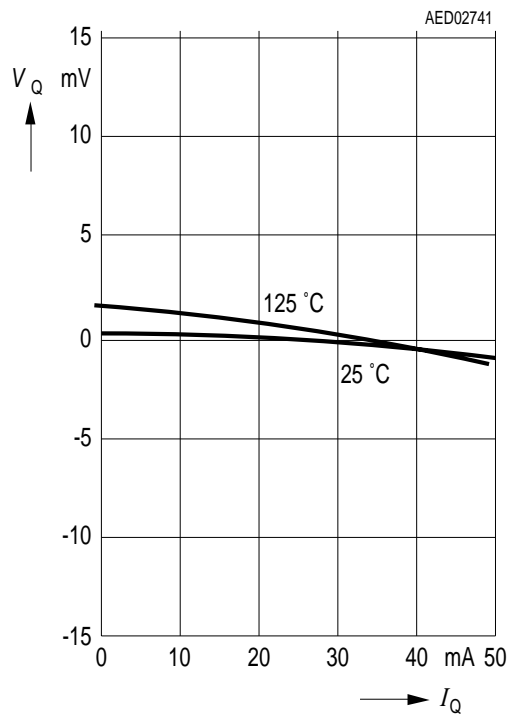

Output Voltage V_Q versus Adjust Voltage V_{ADJ} , $V_I > V_{ADJ}$

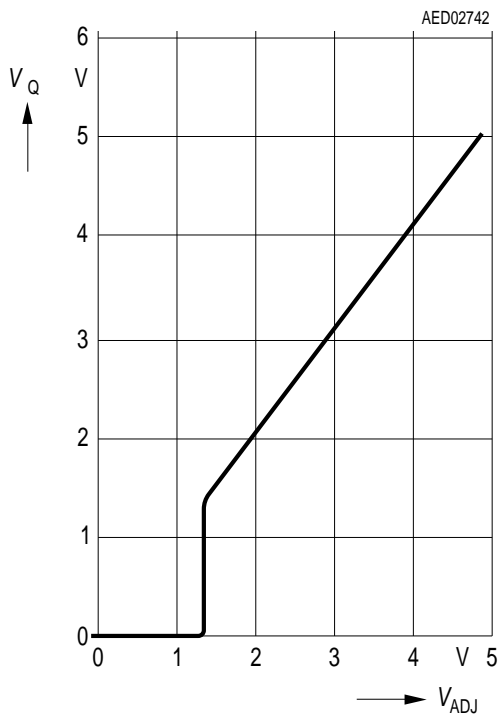

Output Voltage V_Q versus Input Voltage V_I , $V_{ADJ} = 5 V$

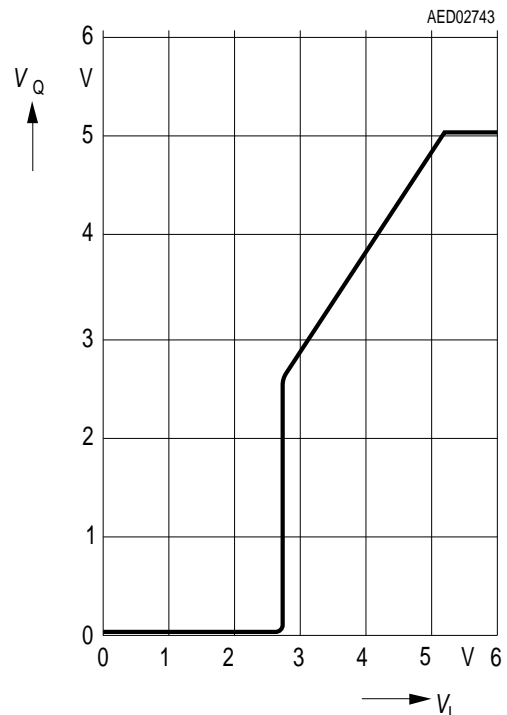

Drop Voltage V_{DR} versus Output Current I_Q , $V_{ADJ} = 5 V$

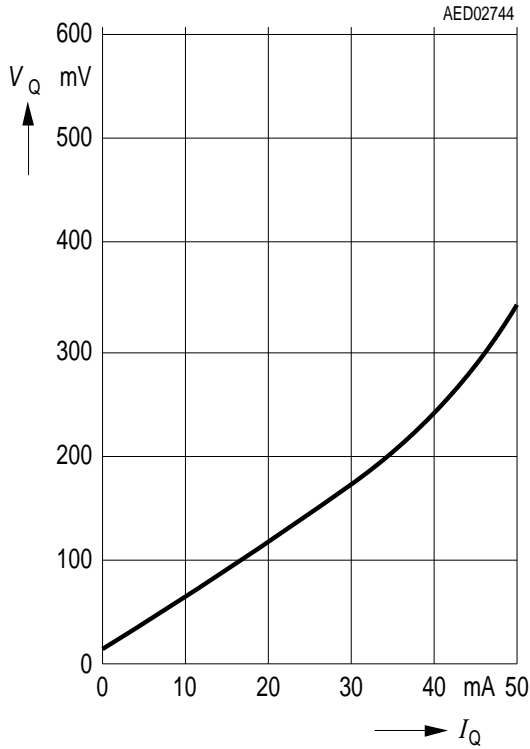

Current Consumption I_q versus Output Current I_Q

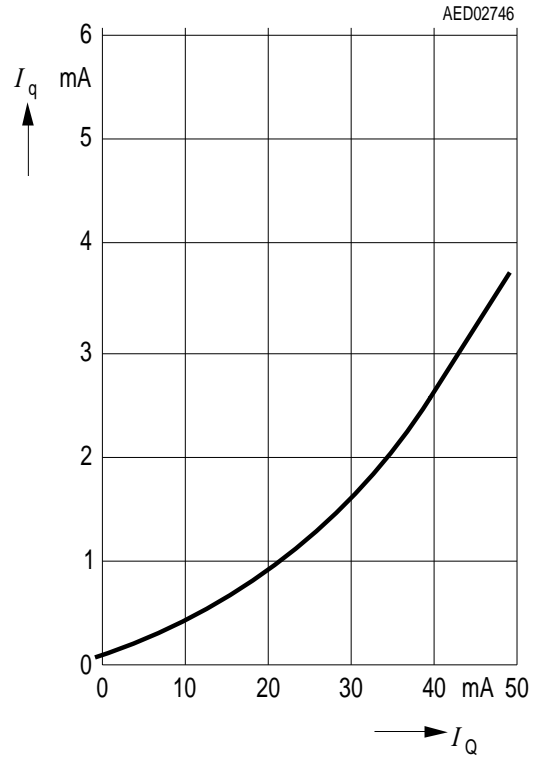

Output Current I_Q versus Input Voltage V_I

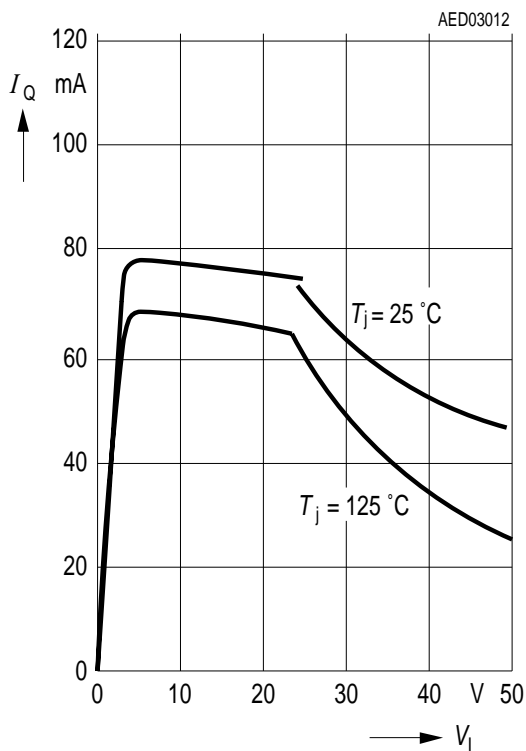

Current Consumption I_q versus Input Voltage V_I , $V_{ADJ} = 5 V$

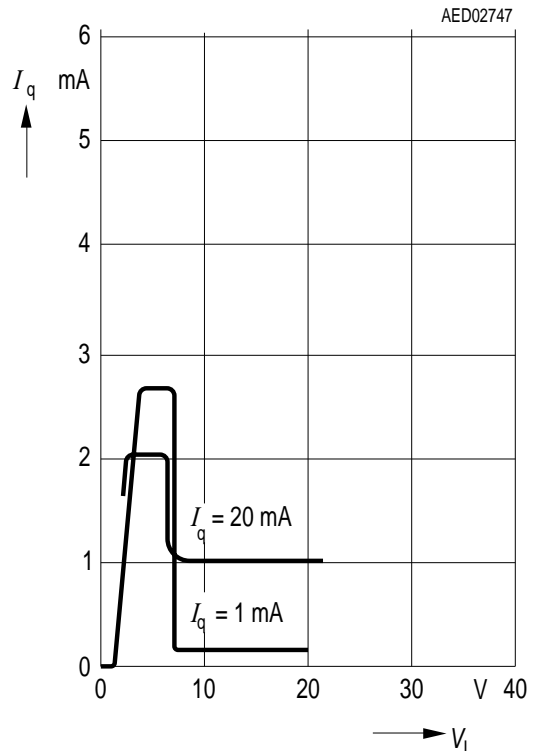

Package Outlines

SCT-595
(Special Package)

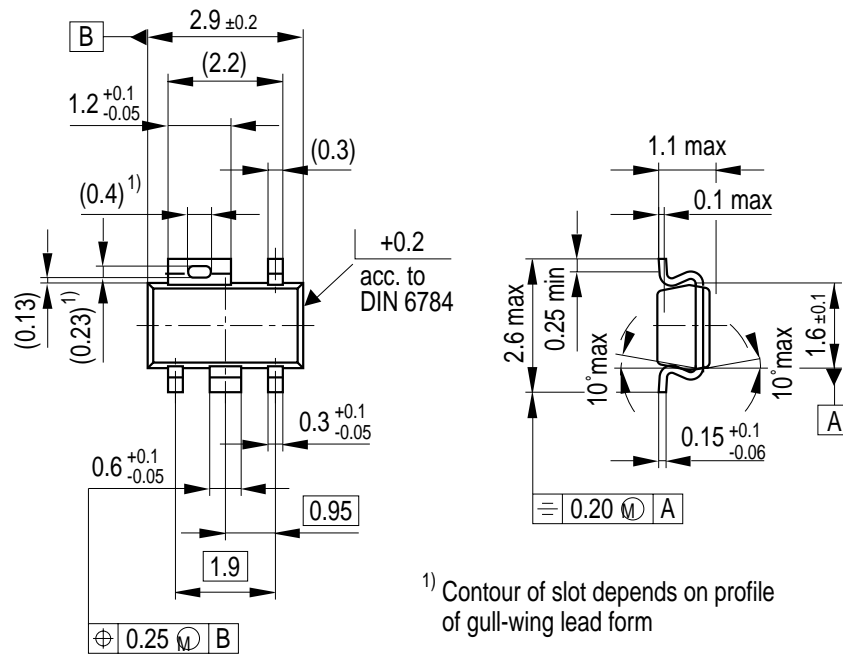

Sorts of Packing

Package outlines for tubes, trays etc. are contained in our Data Book "Package Information".

SMD = Surface Mounted Device

Dimensions in mm

Edition 2000-10-04

**Published by Infineon Technologies AG,
St.-Martin-Strasse 53,
D-81541 München**

**© Infineon Technologies AG 2000.
All Rights Reserved.**

Attention please!

The information herein is given to describe certain components and shall not be considered as warranted characteristics.

Terms of delivery and rights to technical change reserved.

We hereby disclaim any and all warranties, including but not limited to warranties of non-infringement, regarding circuits, descriptions and charts stated herein.

Infineon Technologies is an approved CECC manufacturer.

Information

For further information on technology, delivery terms and conditions and prices please contact your nearest Infineon Technologies Office in Germany or our Infineon Technologies Representatives worldwide (see address list).

Warnings

Due to technical requirements components may contain dangerous substances. For information on the types in question please contact your nearest Infineon Technologies Office.

Infineon Technologies Components may only be used in life-support devices or systems with the express written approval of Infineon Technologies, if a failure of such components can reasonably be expected to cause the failure of that life-support device or system, or to affect the safety or effectiveness of that device or system. Life support devices or systems are intended to be implanted in the human body, or to support and/or maintain and sustain and/or protect human life. If they fail, it is reasonable to assume that the health of the user or other persons may be endangered.