

**Features**

- Advanced Process Technology
- Ultra Low On-Resistance
- 175°C Operating Temperature
- Fast Switching
- Repetitive Avalanche Allowed up to Tjmax

**Description**

Specifically designed for Automotive applications, this HEXFET® Power MOSFET utilizes the latest processing techniques to achieve extremely low on-resistance per silicon area. Additional features of this design are a 175°C junction operating temperature, fast switching speed and improved repetitive avalanche rating. These features combine to make this design an extremely efficient and reliable device for use in Automotive applications and a wide variety of other applications.

**HEXFET® Power MOSFET**

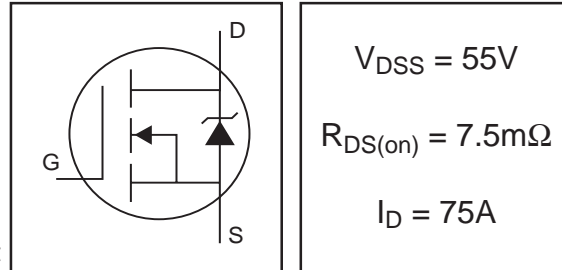

$V_{DSS} = 55V$

$R_{DS(on)} = 7.5m\Omega$

$I_D = 75A$

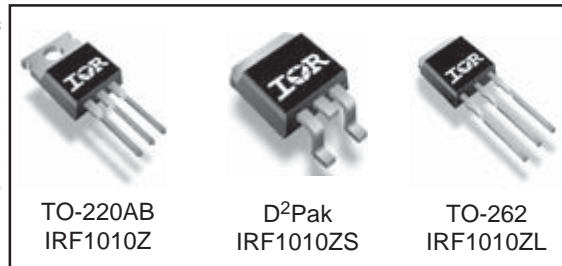

TO-220AB  
IRF1010Z

D²Pak  
IRF1010ZS

TO-262  
IRF1010ZL

**Absolute Maximum Ratings**

|                              | Parameter  | Max.                     | Units |
|------------------------------|--|--------------------------|-------|
| $I_D @ T_C = 25^\circ C$     | Continuous Drain Current, $V_{GS} @ 10V$ (Silicon Limited) | 94                       | A     |
| $I_D @ T_C = 100^\circ C$    | Continuous Drain Current, $V_{GS} @ 10V$                   | 66                       |       |
| $I_D @ T_C = 25^\circ C$     | Continuous Drain Current, $V_{GS} @ 10V$ (Package Limited) | 75                       |       |
| $I_{DM}$                     | Pulsed Drain Current ①                                     | 360                      |       |
| $P_D @ T_C = 25^\circ C$     | Power Dissipation  | 140                      | W     |
|                              | Linear Derating Factor                                     | 0.90                     | W/°C  |
| $V_{GS}$                     | Gate-to-Source Voltage                                     | $\pm 20$                 | V     |
| $E_{AS}$ (Thermally limited) | Single Pulse Avalanche Energy ②                            | 130                      | mJ    |
| $E_{AS}$ (Tested)            | Single Pulse Avalanche Energy Tested Value ③               | 180                      |       |
| $I_{AR}$                     | Avalanche Current ①  | See Fig.12a, 12b, 15, 16 | A     |
| $E_{AR}$                     | Repetitive Avalanche Energy ⑤                              |                          | mJ    |
| $T_J$                        | Operating Junction and                                     | -55 to + 175             | °C    |
| $T_{STG}$                    | Storage Temperature Range                                  |                          |       |
|                              | Soldering Temperature, for 10 seconds                      | 300 (1.6mm from case)    |       |
|                              | Mounting Torque, 6-32 or M3 screw ⑦                        | 10 lbf•in (1.1N•m)       |       |

**Thermal Resistance**

|                 | Parameter                            | Typ. | Max. | Units |
|-----------------|--------------------------------------|------|------|-------|
| $R_{\theta JC}$ | Junction-to-Case                     | —    | 1.11 | °C/W  |
| $R_{\theta CS}$ | Case-to-Sink, Flat Greased Surface ⑦ | 0.50 | —    |       |
| $R_{\theta JA}$ | Junction-to-Ambient ⑦                | —    | 62   |       |
| $R_{\theta JA}$ | Junction-to-Ambient (PCB Mount) ⑧    | —    | 40   |       |

## Electrical Characteristics @ $T_J = 25^\circ\text{C}$ (unless otherwise specified)

|                                 | Parameter                            | Min. | Typ.  | Max. | Units      | Conditions  |
|---------------------------------|--------------------------------------|------|-------|------|------------|---|
| $V_{(BR)DSS}$                   | Drain-to-Source Breakdown Voltage    | 55   | —     | —    | V          | $V_{GS} = 0V, I_D = 250\mu A$   |
| $\Delta V_{(BR)DSS}/\Delta T_J$ | Breakdown Voltage Temp. Coefficient  | —    | 0.049 | —    | V/°C       | Reference to $25^\circ\text{C}$ , $I_D = 1mA$                               |
| $R_{DS(on)}$                    | Static Drain-to-Source On-Resistance | —    | 5.8   | 7.5  | m $\Omega$ | $V_{GS} = 10V, I_D = 75A$ ③   |
| $V_{GS(th)}$                    | Gate Threshold Voltage               | 2.0  | —     | 4.0  | V          | $V_{DS} = V_{GS}, I_D = 250\mu A$   |
| gfs                             | Forward Transconductance             | 33   | —     | —    | S          | $V_{DS} = 25V, I_D = 75A$   |
| $I_{DSS}$                       | Drain-to-Source Leakage Current      | —    | —     | 20   | $\mu A$    | $V_{DS} = 55V, V_{GS} = 0V$   |
|                                 |                                      | —    | —     | 250  |            | $V_{DS} = 55V, V_{GS} = 0V, T_J = 125^\circ\text{C}$                        |
| $I_{GSS}$                       | Gate-to-Source Forward Leakage       | —    | —     | 200  | nA         | $V_{GS} = 20V$  |
|                                 | Gate-to-Source Reverse Leakage       | —    | —     | -200 |            | $V_{GS} = -20V$   |
| $Q_g$                           | Total Gate Charge                    | —    | 63    | 95   | nC         | $I_D = 75A$   |
| $Q_{gs}$                        | Gate-to-Source Charge                | —    | 19    | —    |            | $V_{DS} = 44V$  |
| $Q_{gd}$                        | Gate-to-Drain ("Miller") Charge      | —    | 24    | —    |            | $V_{GS} = 10V$ ③  |
| $t_{d(on)}$                     | Turn-On Delay Time                   | —    | 18    | —    | ns         | $V_{DD} = 28V$  |
| $t_r$                           | Rise Time                            | —    | 150   | —    |            | $I_D = 75A$   |
| $t_{d(off)}$                    | Turn-Off Delay Time                  | —    | 36    | —    |            | $R_G = 6.8\ \Omega$   |
| $t_f$                           | Fall Time                            | —    | 92    | —    |            | $V_{GS} = 10V$ ③  |
| $L_D$                           | Internal Drain Inductance            | —    | 4.5   | —    | nH         | Between lead,<br>6mm (0.25in.)<br>from package<br>and center of die contact |
| $L_S$                           | Internal Source Inductance           | —    | 7.5   | —    |            |   |
| $C_{iss}$                       | Input Capacitance                    | —    | 2840  | —    | pF         | $V_{GS} = 0V$   |
| $C_{oss}$                       | Output Capacitance                   | —    | 420   | —    |            | $V_{DS} = 25V$  |
| $C_{riss}$                      | Reverse Transfer Capacitance         | —    | 250   | —    |            | $f = 1.0MHz$  |
| $C_{oss}$                       | Output Capacitance                   | —    | 1630  | —    |            | $V_{GS} = 0V, V_{DS} = 1.0V, f = 1.0MHz$                                    |
| $C_{oss}$                       | Output Capacitance                   | —    | 360   | —    |            | $V_{GS} = 0V, V_{DS} = 44V, f = 1.0MHz$                                     |
| $C_{oss\ eff.}$                 | Effective Output Capacitance         | —    | 560   | —    |            | $V_{GS} = 0V, V_{DS} = 0V\ to\ 44V$ ④                                       |

## Source-Drain Ratings and Characteristics

|          | Parameter                                 | Min.  | Typ. | Max. | Units | Conditions  |
|----------|---|---|------|------|-------|---|
| $I_S$    | Continuous Source Current<br>(Body Diode) | —   | —    | 75   | A     | MOSFET symbol<br>showing the<br>integral reverse<br>p-n junction diode. |
| $I_{SM}$ | Pulsed Source Current<br>(Body Diode) ①   | —   | —    | 360  |       |   |
| $V_{SD}$ | Diode Forward Voltage                     | —   | —    | 1.3  | V     | $T_J = 25^\circ\text{C}, I_S = 75A, V_{GS} = 0V$ ③                      |
| $t_{rr}$ | Reverse Recovery Time                     | —   | 22   | 33   | ns    | $T_J = 25^\circ\text{C}, I_F = 75A, V_{DD} = 25V$                       |
| $Q_{rr}$ | Reverse Recovery Charge                   | —   | 15   | 23   | nC    | $di/dt = 100A/\mu s$ ③  |
| $t_{on}$ | Forward Turn-On Time                      | Intrinsic turn-on time is negligible (turn-on is dominated by $L_S+L_D$ ) |      |      |       |   |

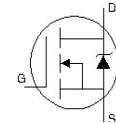

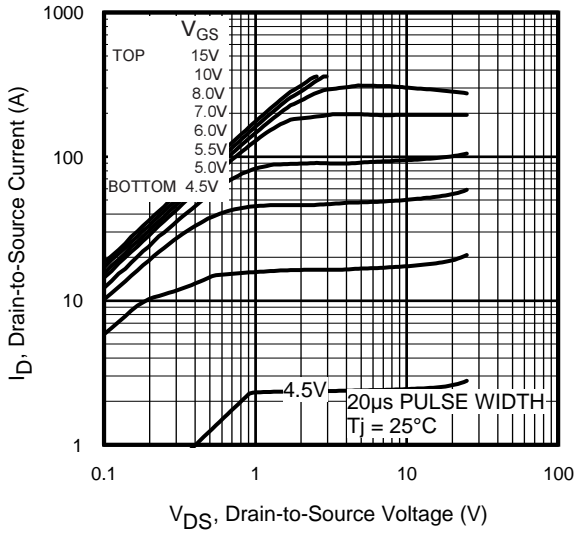

Fig 1. Typical Output Characteristics

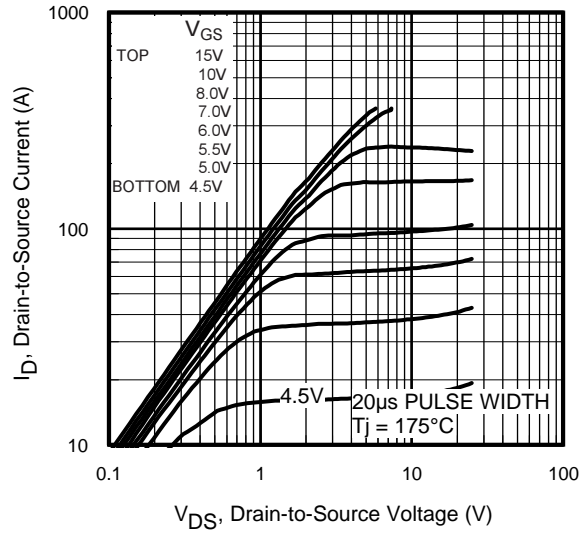

Fig 2. Typical Output Characteristics

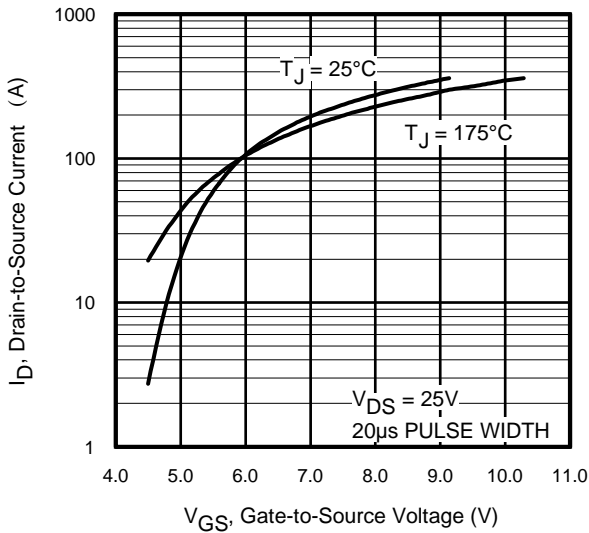

Fig 3. Typical Transfer Characteristics

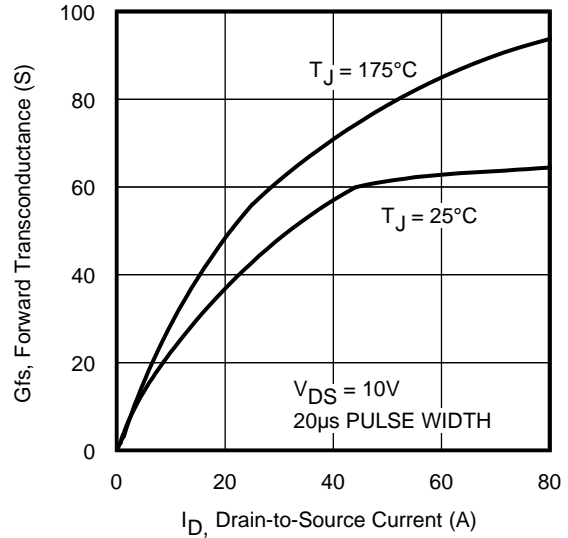
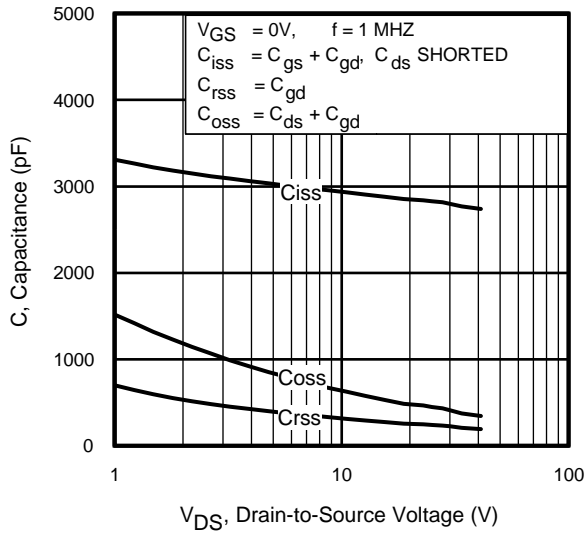
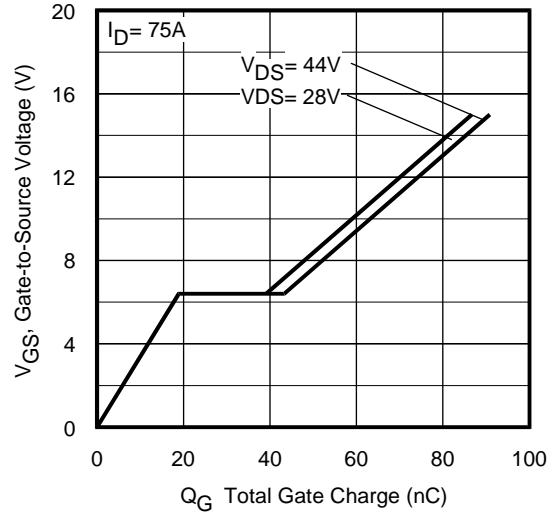

Fig 4. Typical Forward Transconductance Vs. Drain Current



**Fig 5.** Typical Capacitance Vs. Drain-to-Source Voltage



**Fig 6.** Typical Gate Charge Vs. Gate-to-Source Voltage

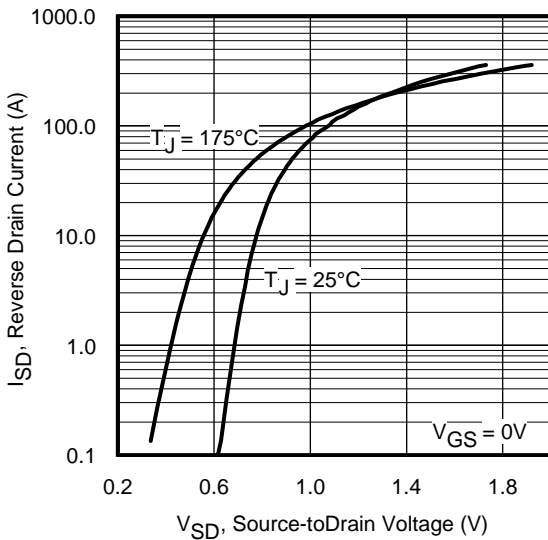

**Fig 7.** Typical Source-Drain Diode Forward Voltage

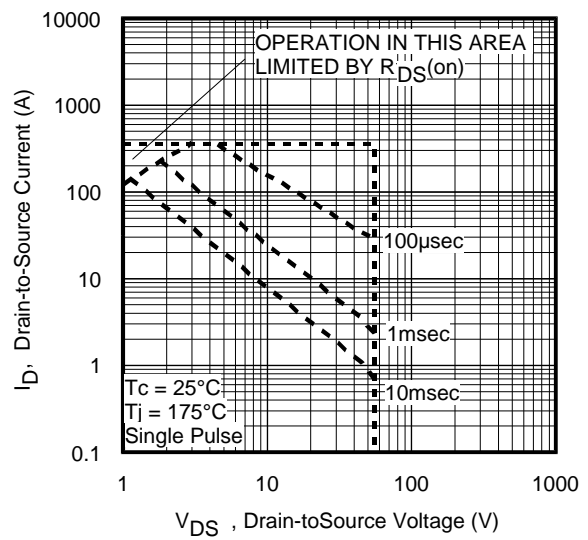

**Fig 8.** Maximum Safe Operating Area

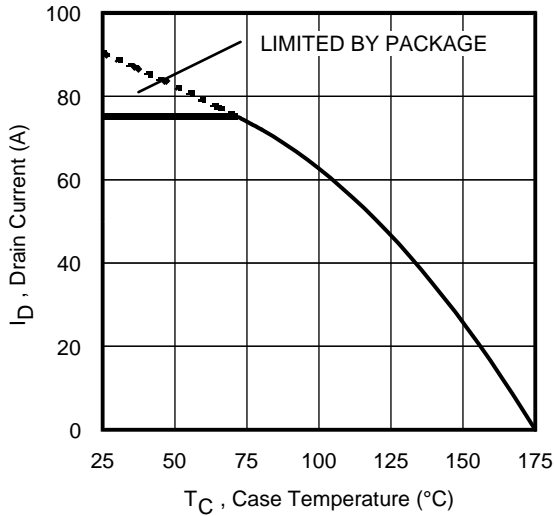

Fig 9. Maximum Drain Current Vs. Case Temperature

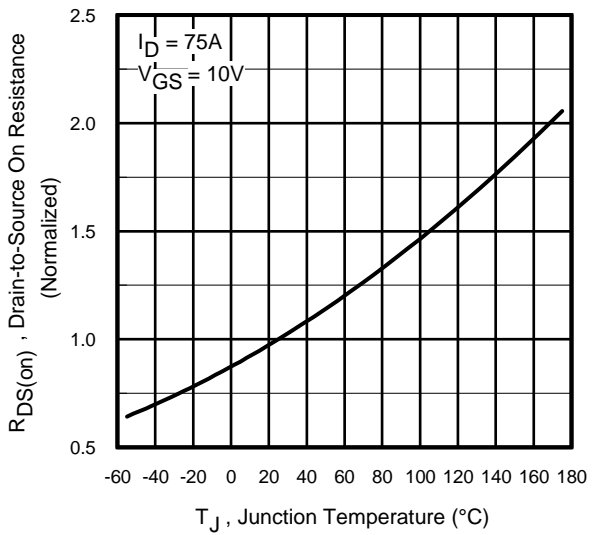

Fig 10. Normalized On-Resistance Vs. Temperature

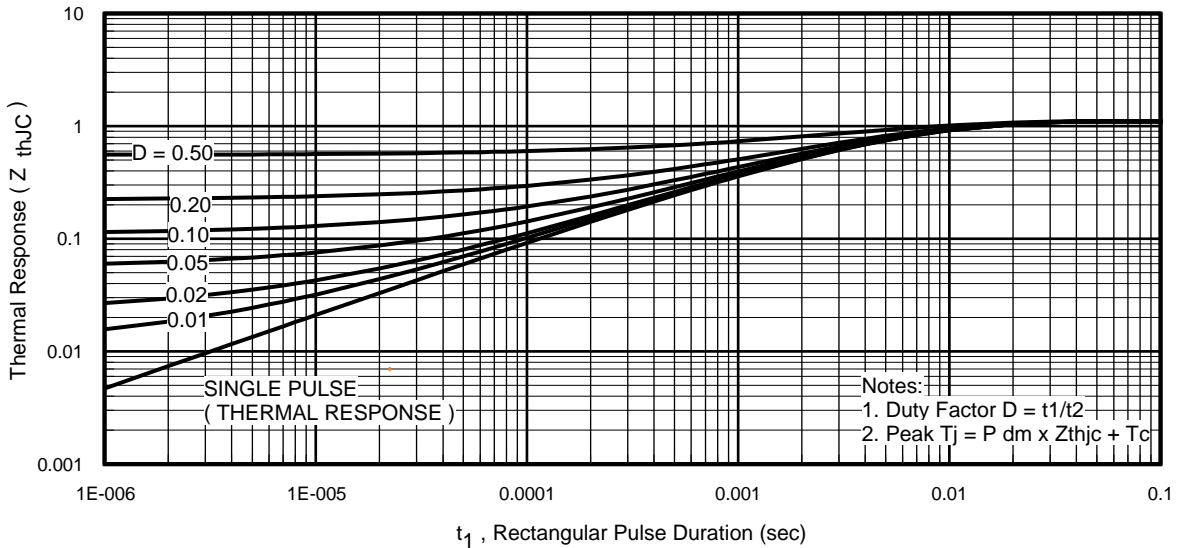

Fig 11. Maximum Effective Transient Thermal Impedance, Junction-to-Case

# IRF1010ZS/L



**Fig 12a.** Unclamped Inductive Test Circuit



**Fig 12b.** Unclamped Inductive Waveforms

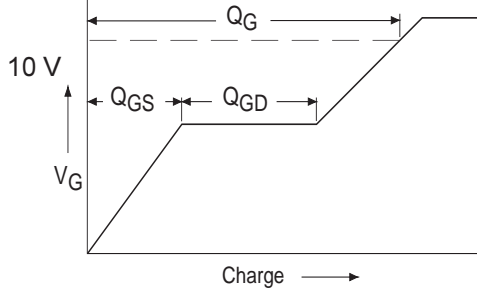

**Fig 13a.** Basic Gate Charge Waveform

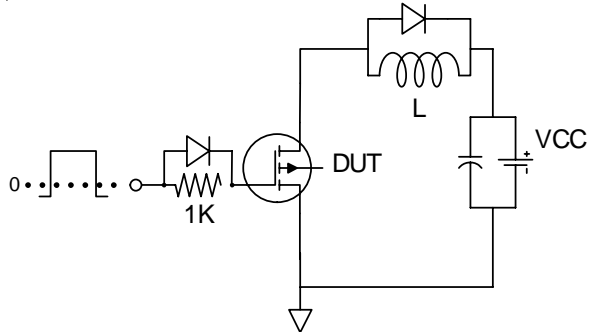

**Fig 13b.** Gate Charge Test Circuit

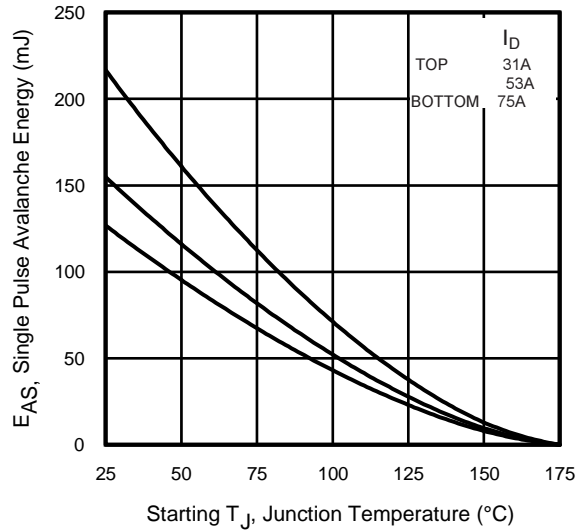

**Fig 12c.** Maximum Avalanche Energy Vs. Drain Current

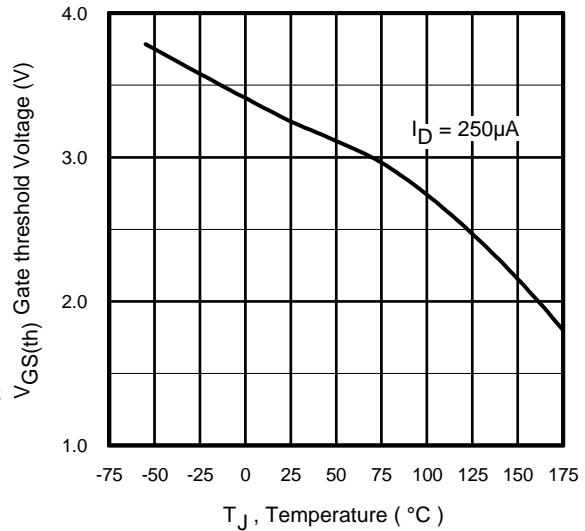

**Fig 14.** Threshold Voltage Vs. Temperature

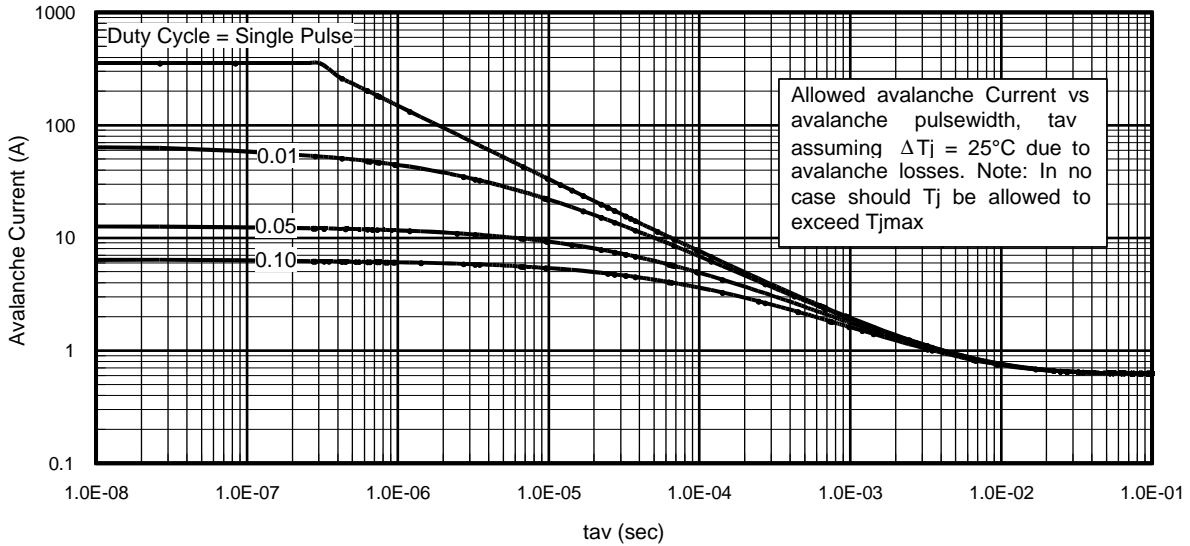

Fig 15. Typical Avalanche Current Vs.Pulsewidth

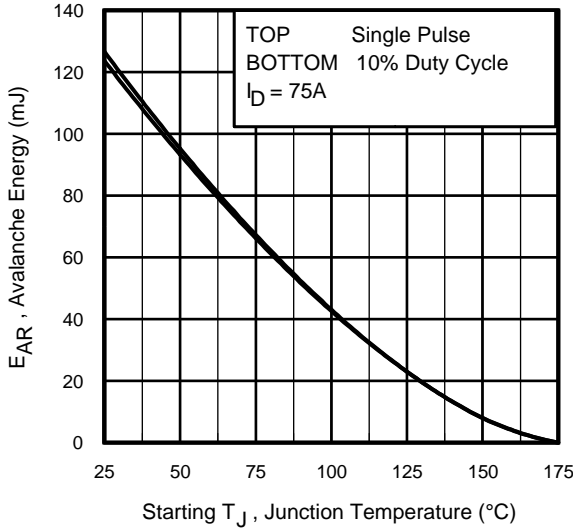

Fig 16. Maximum Avalanche Energy Vs. Temperature

**Notes on Repetitive Avalanche Curves , Figures 15, 16:**  
(For further info, see AN-1005 at [www.irf.com](http://www.irf.com))

1. Avalanche failures assumption:  
Purely a thermal phenomenon and failure occurs at a temperature far in excess of  $T_{jmax}$ . This is validated for every part type.
2. Safe operation in Avalanche is allowed as long as  $T_{jmax}$  is not exceeded.
3. Equation below based on circuit and waveforms shown in Figures 12a, 12b.
4.  $P_{D(ave)}$  = Average power dissipation per single avalanche pulse.
5. BV = Rated breakdown voltage (1.3 factor accounts for voltage increase during avalanche).
6.  $I_{av}$  = Allowable avalanche current.
7.  $\Delta T$  = Allowable rise in junction temperature, not to exceed  $T_{jmax}$  (assumed as 25°C in Figure 15, 16).  
 $t_{av}$  = Average time in avalanche.  
 $D$  = Duty cycle in avalanche =  $t_{av} \cdot f$   
 $Z_{thJC}(D, t_{av})$  = Transient thermal resistance, see figure 11)

$$P_{D(ave)} = 1/2 ( 1.3 \cdot BV \cdot I_{av} ) = \Delta T / Z_{thJC}$$

$$I_{av} = 2\Delta T / [1.3 \cdot BV \cdot Z_{th}]$$

$$E_{AS(AR)} = P_{D(ave)} \cdot t_{av}$$

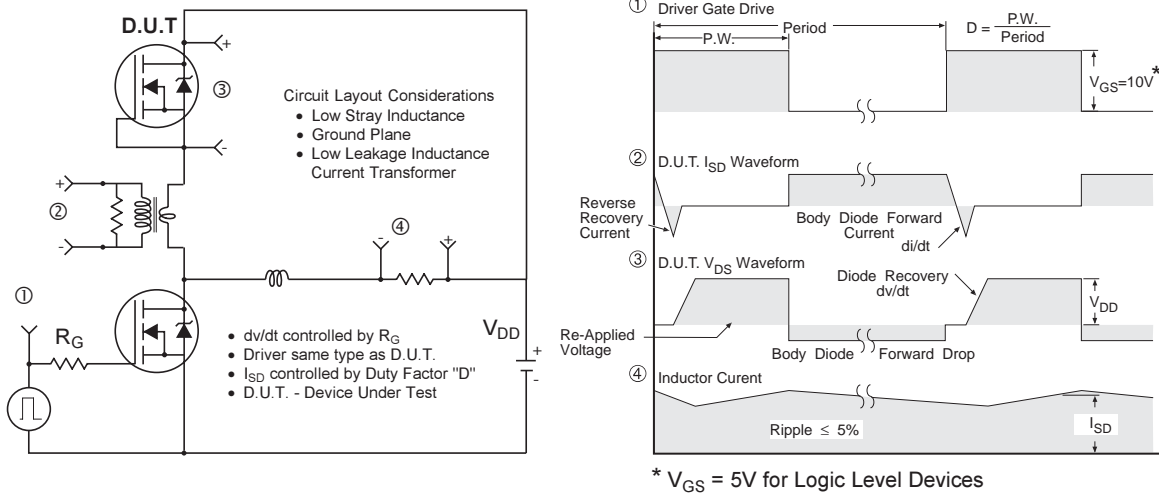

**Fig 17. Peak Diode Recovery  $dv/dt$  Test Circuit for N-Channel HEXFET® Power MOSFETs**

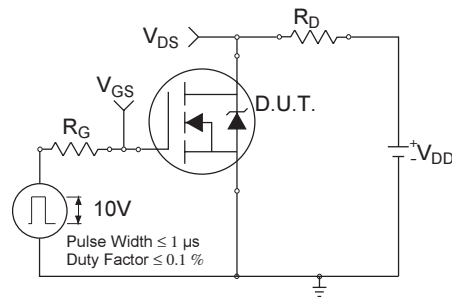

**Fig 18a. Switching Time Test Circuit**

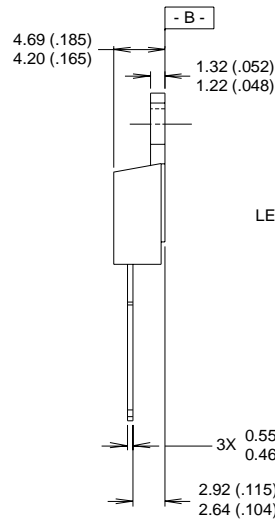
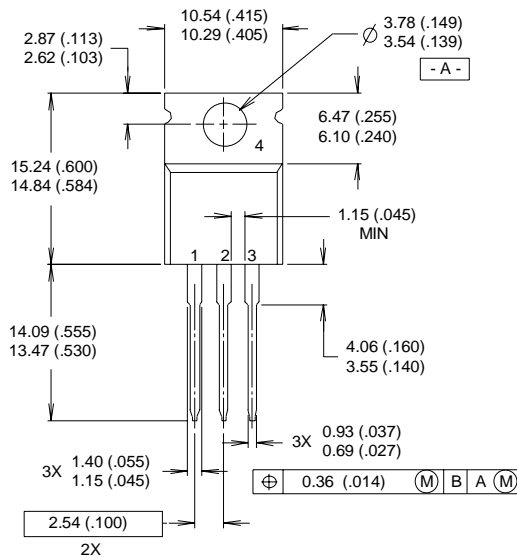

**Fig 18b. Switching Time Waveforms**



## TO-220AB Package Outline

Dimensions are shown in millimeters (inches)



- LEAD ASSIGNMENTS**
- 1 - GATE
  - 2 - DRAIN
  - 3 - SOURCE
  - 4 - DRAIN

**NOTES:**

- 1 DIMENSIONING & TOLERANCING PER ANSI Y14.5M, 1982.
- 2 CONTROLLING DIMENSION : INCH
- 3 OUTLINE CONFORMS TO JEDEC OUTLINE TO-220AB.
- 4 HEATSINK & LEAD MEASUREMENTS DO NOT INCLUDE BURRS.

## TO-220AB Part Marking Information

EXAMPLE: THIS IS AN IRF1010  
 LOT CODE 1789  
 ASSEMBLED ON WW 19, 1997  
 IN THE ASSEMBLY LINE "C"

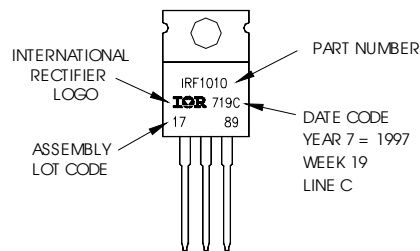

**For GB Production**

EXAMPLE: THIS IS AN IRF1010  
 LOT CODE 1789  
 ASSEMBLED ON WW 19, 1997  
 IN THE ASSEMBLY LINE "C"

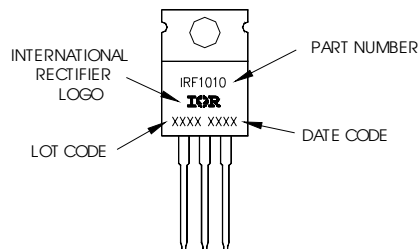

# IRF1010ZS/L

## D<sup>2</sup>Pak Package Outline

Dimensions are shown in millimeters (inches)

International  
**IR** Rectifier

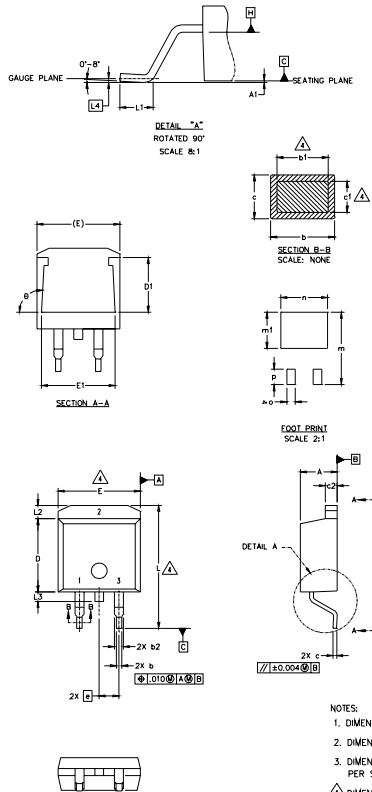

| SYMBOL | DIMENSIONS  |       |          |      | NOTES |
|--------|-------------|-------|----------|------|-------|
|        | MILLIMETERS |       | INCHES   |      |       |
|        | MIN.        | MAX.  | MIN.     | MAX. |       |
| A      | 4.06        | 4.83  | .160     | .190 | 4     |
| A1     |             | 0.127 |          | .005 |       |
| b      | 0.51        | 0.99  | .020     | .039 |       |
| b1     | 0.51        | 0.89  | .020     | .035 |       |
| b2     | 1.14        | 1.40  | .045     | .055 | 4     |
| c      | 0.43        | 0.63  | .017     | .025 |       |
| c1     | 0.38        | 0.74  | .015     | .029 | 3     |
| c2     | 1.14        | 1.40  | .045     | .055 |       |
| D      | 8.51        | 9.65  | .335     | .380 | 3     |
| D1     | 5.33        |       | .210     |      |       |
| E      | 9.65        | 10.67 | .380     | .420 | 3     |
| E1     | 6.22        |       | .245     |      |       |
| e      | 2.54 BSC    |       | .100 BSC |      |       |
| L      | 14.61       | 15.88 | .575     | .625 |       |
| L1     | 1.78        | 2.79  | .070     | .110 |       |
| L2     |             | 1.65  |          | .065 |       |
| L3     | 1.27        | 1.78  | .050     | .070 |       |
| L4     | 0.25 BSC    |       | .010 BSC |      |       |
| m      | 17.78       |       | .700     |      |       |
| m1     | 8.89        |       | .350     |      |       |
| n      | 11.43       |       | .450     |      |       |
| o      | 2.08        |       | .082     |      |       |
| p      | 3.81        |       | .150     |      |       |
| θ      | 90°         | 93°   | 90°      | 93°  |       |

### LEAD ASSIGNMENTS

| HEXFET     | IGBTs, CoPACK | DIODES      |
|------------|---------------|-------------|
| 1.- GATE   | 1.- GATE      | 1.- ANODE * |
| 2.- DRAIN  | 2.- COLLECTOR | 2.- CATHODE |
| 3.- SOURCE | 3.- EMITTER   | 3.- ANODE   |

\* PART DEPENDENT.

### NOTES:

1. DIMENSIONING AND TOLERANCING PER ASME Y14.5M-1994
2. DIMENSIONS ARE SHOWN IN MILLIMETERS (INCHES)
3. DIMENSION D & E DO NOT INCLUDE MOLD FLASH. MOLD FLASH SHALL NOT EXCEED 0.127 [0.005"] PER SIDE. THESE DIMENSIONS ARE MEASURED AT THE OUTMOST EXTREMES OF THE PLASTIC BODY.
4. DIMENSION b1 AND c1 APPLY TO BASE METAL ONLY.
5. CONTROLLING DIMENSION: INCH.

## D<sup>2</sup>Pak Part Marking Information

EXAMPLE: THIS IS AN IRF530S WITH  
LOT CODE 8024  
ASSEMBLED ON WW02, 2000  
IN THE ASSEMBLY LINE "L"

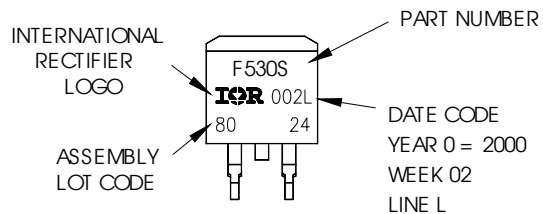

For GB Production

EXAMPLE: THIS IS AN IRF530S WITH  
LOT CODE 8024  
ASSEMBLED ON WW02, 2000  
IN THE ASSEMBLY LINE "L"

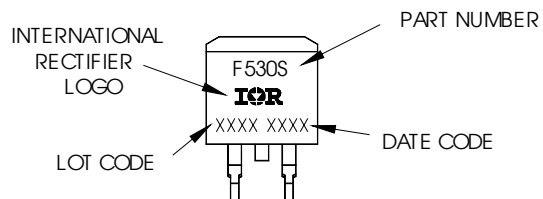

## TO-262 Package Outline

Dimensions are shown in millimeters (inches)

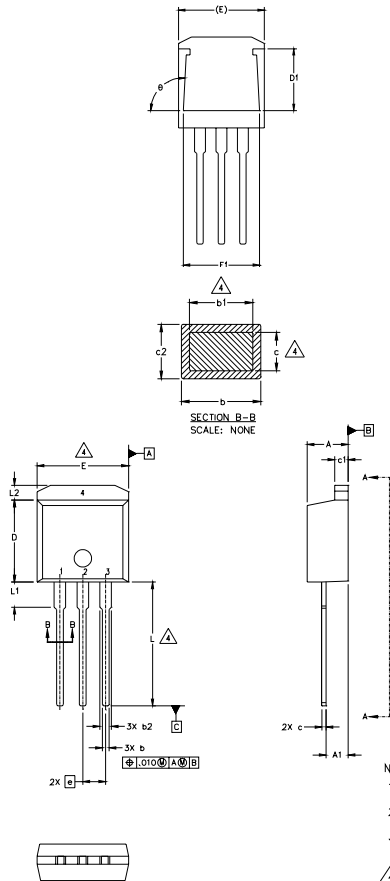

| SYMBOL | DIMENSIONS  |       |          |      | NOTES |
|--------|-------------|-------|----------|------|-------|
|        | MILLIMETERS |       | INCHES   |      |       |
|        | MIN.        | MAX.  | MIN.     | MAX. |       |
| A      | 4.06        | 4.83  | .160     | .190 |       |
| A1     | 2.03        | 2.92  | .080     | .115 |       |
| b      | 0.51        | 0.99  | .020     | .039 |       |
| b1     | 0.51        | 0.89  | .020     | .035 | 4     |
| b2     | 1.14        | 1.40  | .045     | .055 |       |
| c      | 0.38        | 0.63  | .015     | .025 | 4     |
| c1     | 1.14        | 1.40  | .045     | .055 |       |
| c2     | 0.43        | .063  | .017     | .029 |       |
| D      | 8.51        | 9.65  | .335     | .380 | 3     |
| D1     | 5.33        |       | .210     |      |       |
| E      | 9.65        | 10.67 | .380     | .420 | 3     |
| E1     | 6.22        |       | .245     |      |       |
| e      | 2.54 BSC    |       | .100 BSC |      |       |
| L      | 13.46       | 14.09 | .530     | .555 |       |
| L1     | 3.56        | 3.71  | .140     | .146 |       |
| L2     |             | 1.65  |          | .065 |       |

### LEAD ASSIGNMENTS

#### HEXFET

- 1.- GATE
- 2.- DRAIN
- 3.- SOURCE
- 4.- DRAIN

#### IGBT

- 1- GATE
- 2- COLLECTOR

#### NOTES:

1. DIMENSIONING AND TOLERANCING PER ASME Y14.5M-1994
2. DIMENSIONS ARE SHOWN IN MILLIMETERS [INCHES].
3. DIMENSION D & E DO NOT INCLUDE MOLD FLASH. MOLD FLASH SHALL NOT EXCEED 0.127 [0.005"] PER SIDE. THESE DIMENSIONS ARE MEASURED AT THE OUTMOST EXTREMES OF THE PLASTIC BODY.
4. DIMENSION b1 AND c1 APPLY TO BASE METAL ONLY.
5. CONTROLLING DIMENSION: INCH.

## TO-262 Part Marking Information

EXAMPLE: THIS IS AN IRL3103L  
LOT CODE 1789  
ASSEMBLED ON WW 19, 1997  
IN THE ASSEMBLY LINE "C"

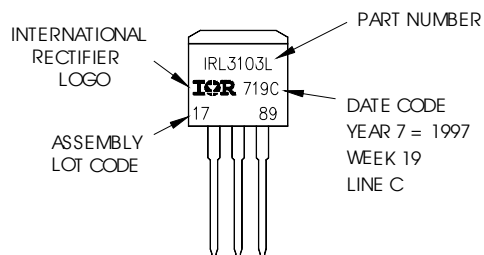

# IRF1010ZS/L

## D<sup>2</sup>Pak Tape & Reel Information

International  
**IR** Rectifier

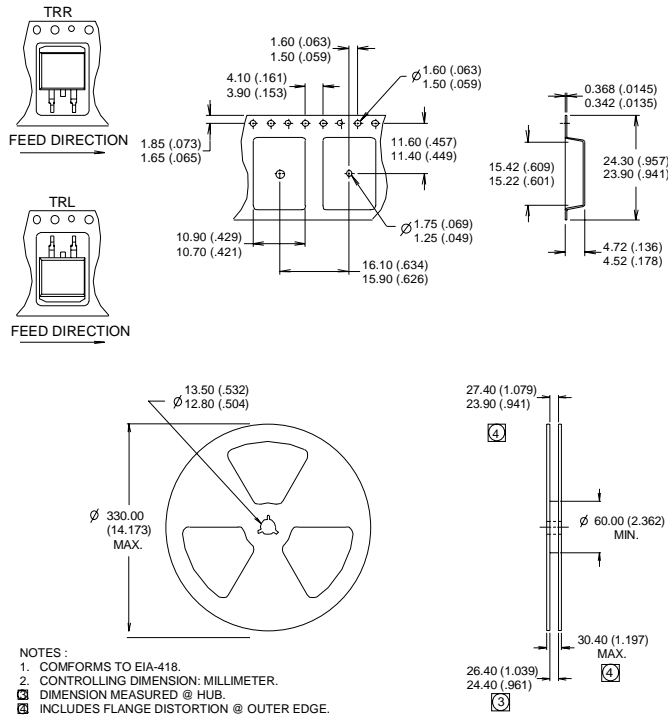

### Notes:

- ① Repetitive rating; pulse width limited by max. junction temperature. (See fig. 11).
- ② Limited by  $T_{Jmax}$ , starting  $T_J = 25^\circ\text{C}$ ,  $L = 0.05\text{mH}$ ,  $R_G = 25\Omega$ ,  $I_{AS} = 75\text{A}$ ,  $V_{GS} = 10\text{V}$ . Part not recommended for use above this value.
- ③ Pulse width  $\leq 1.0\text{ms}$ ; duty cycle  $\leq 2\%$ .
- ④  $C_{oss}$  eff. is a fixed capacitance that gives the same charging time as  $C_{oss}$  while  $V_{DS}$  is rising from 0 to 80%  $V_{DSS}$ .
- ⑤ Limited by  $T_{Jmax}$ , see Fig.12a, 12b, 15, 16 for typical repetitive avalanche performance.
- ⑥ This value determined from sample failure population. 100% tested to this value in production.
- ⑦ This is only applied to TO-220AB package.
- ⑧ This is applied to D<sup>2</sup>Pak, when mounted on 1" square PCB (FR-4 or G-10 Material). For recommended footprint and soldering techniques refer to application note #AN-994.

**TO-220AB package is not recommended for Surface Mount Application.**

Data and specifications subject to change without notice.  
This product has been designed and qualified for the Automotive [Q101]market.  
Qualification Standards can be found on IR's Web site.

International  
**IR** Rectifier

**IR WORLD HEADQUARTERS:** 233 Kansas St., El Segundo, California 90245, USA Tel: (310) 252-7105  
TAC Fax: (310) 252-7903

Visit us at [www.irf.com](http://www.irf.com) for sales contact information. 09/03

[www.irf.com](http://www.irf.com)