

- Co-packaged HEXFET® Power MOSFET and Schottky Diode
- Ideal For Synchronous Regulator Applications
- Generation V Technology
- SO-8 Footprint

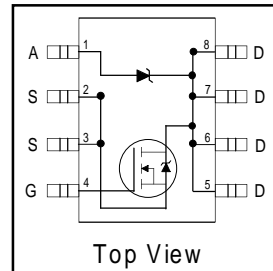

$V_{DSS} = 30V$
$R_{DS(on)} = 0.035\Omega$
Schottky Vf = 0.39V

Description

The **FETKY™** family of co-packaged HEXFETs and Schottky diodes offer the designer an innovative board space saving solution for switching regulator applications. Generation 5 HEXFETs utilize advanced processing techniques to achieve extremely low on-resistance per silicon area. Combining this technology with International Rectifier's low forward drop Schottky rectifiers results in an extremely efficient device suitable for use in a wide variety of portable electronics applications.

The SO-8 has been modified through a customized leadframe for enhanced thermal characteristics. The SO-8 package is designed for vapor phase, infrared or wave soldering techniques.

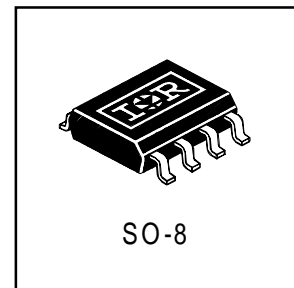

Absolute Maximum Ratings (T_A = 25°C unless otherwise noted)

Parameter		Maximum	Units
I _D @ T _A = 25°C	Continuous Drain Current, V _{GS} @10V ^④	5.8	A
I _D @ T _A = 70°C		4.6	
I _{DM}	Pulsed Drain Current ^①	46	
P _D @ T _A = 25°C	Power Dissipation ^④	2.0	W
P _D @ T _A = 70°C		1.3	
	Linear Derating Factor	16	W/°C
V _{GS}	Gate-to-Source Voltage	± 20	V
dv/dt	Peak Diode Recovery dv/dt ^②	-5.0	V/ns
T _J , T _{STG}	Junction and Storage Temperature Range	-55 to +150	°C

Thermal Resistance Ratings

Parameter		Maximum	Units
R _{θJA}	Junction-to-Ambient ^④	62.5	°C/W

Notes:

- ① Repetitive rating; pulse width limited by maximum junction temperature (see figure 11)
- ② I_{SD} ≤ 4.1A, di/dt ≤ 110A/μs, V_{DD} ≤ V_{(BR)DSS}, T_J ≤ 150°C
- ③ Pulse width ≤ 300μs; duty cycle ≤ 2%
- ④ Surface mounted on FR-4 board, t ≤ 10sec.

IRF7421D1

International
IR Rectifier

2

MOSFET Electrical Characteristics @ $T_J = 25^\circ\text{C}$ (unless otherwise specified)

Parameter		Min.	Typ.	Max.	Units	Conditions
$V_{(BR)DSS}$	Drain-to-Source Breakdown Voltage	30	—	—	V	$V_{GS} = 0V, I_D = 250\mu A$
$R_{DS(on)}$	Static Drain-to-Source On-Resistance	—	0.026	0.035	Ω	$V_{GS} = 10V, I_D = 4.1A$ ③
		—	0.040	0.060		$V_{GS} = 4.5V, I_D = 2.1A$ ③
$V_{GS(th)}$	Gate Threshold Voltage	1.0	—	—	V	$V_{DS} = V_{GS}, I_D = 250\mu A$
g_{fs}	Forward Transconductance	4.6	—	—	S	$V_{DS} = 15V, I_D = 2.1A$
I_{DSS}	Drain-to-Source Leakage Current	—	—	1.0	μA	$V_{DS} = 24V, V_{GS} = 0V$
		—	—	25		$V_{DS} = 24V, V_{GS} = 0V, T_J = 125^\circ\text{C}$
I_{GSS}	Gate-to-Source Forward Leakage	—	—	-100	nA	$V_{GS} = -20V$
	Gate-to-Source Reverse Leakage	—	—	100		$V_{GS} = 20V$
Q_g	Total Gate Charge	—	18	27	nC	$I_D = 4.1A$
Q_{gs}	Gate-to-Source Charge	—	2.2	3.3		$V_{DS} = 24V$
Q_{gd}	Gate-to-Drain ("Miller") Charge	—	5.9	8.9		$V_{GS} = 10V$ (see figure 10) ③
$t_{d(on)}$	Turn-On Delay Time	—	6.7	—	ns	$V_{DD} = 15V$
t_r	Rise Time	—	27	—		$I_D = 4.1A$
$t_{d(off)}$	Turn-Off Delay Time	—	20	—		$R_G = 6.2\Omega$
t_f	Fall Time	—	16	—		$R_D = 3.7\Omega$ ③
C_{iss}	Input Capacitance	—	510	—	pF	$V_{GS} = 0V$
C_{oss}	Output Capacitance	—	200	—		$V_{DS} = 25V$
C_{rss}	Reverse Transfer Capacitance	—	84	—		$f = 1.0\text{MHz}$ (see figure 9)

MOSFET Source-Drain Ratings and Characteristics

Parameter		Min.	Typ.	Max.	Units	Conditions
I_S	Continuous Source Current (Body Diode)	—	—	3.1	A	
I_{SM}	Pulsed Source Current (Body Diode)	—	—	33		
V_{SD}	Body Diode Forward Voltage	—	—	1.0	V	$T_J = 25^\circ\text{C}, I_S = 4.1A, V_{GS} = 0V$
t_{rr}	Reverse Recovery Time (Body Diode)	—	57	86	ns	$T_J = 25^\circ\text{C}, I_F = 4.1A$
Q_{rr}	Reverse Recovery Charge	—	93	140	nC	$di/dt = 100A/\mu s$ ③

Schottky Diode Maximum Ratings

	Parameter	Max.	Units	Conditions
$I_{F(av)}$	Max. Average Forward Current	1.7	A	50% Duty Cycle. Rectangular Wave, $T_A = 25^\circ\text{C}$ $T_A = 70^\circ\text{C}$
		1.2		
I_{SM}	Max. peak one cycle Non-repetitive Surge current	120	A	Following any rated load condition & with V_{RRM} applied
		11		

Schottky Diode Electrical Specifications

	Parameter	Max.	Units	Conditions
V_{FM}	Max. Forward voltage drop	0.50	V	$I_F = 1.0A, T_J = 25^\circ\text{C}$
		0.62		$I_F = 2.0A, T_J = 25^\circ\text{C}$
		0.39		$I_F = 1.0A, T_J = 125^\circ\text{C}$
		0.57		$I_F = 2.0A, T_J = 125^\circ\text{C}$
I_{RM}	Max. Reverse Leakage current	0.06	mA	$V_R = 30V, T_J = 25^\circ\text{C}$
		16		$T_J = 125^\circ\text{C}$
C_t	Max. Junction Capacitance	110	pF	$V_R = 5V_{dc}$ (100kHz to 1 MHz) 25°C
dv/dt	Max. Voltage Rate of Charge	3600	V/ μs	Rated V_R

2

www.irf.com

Power Mosfet Characteristics

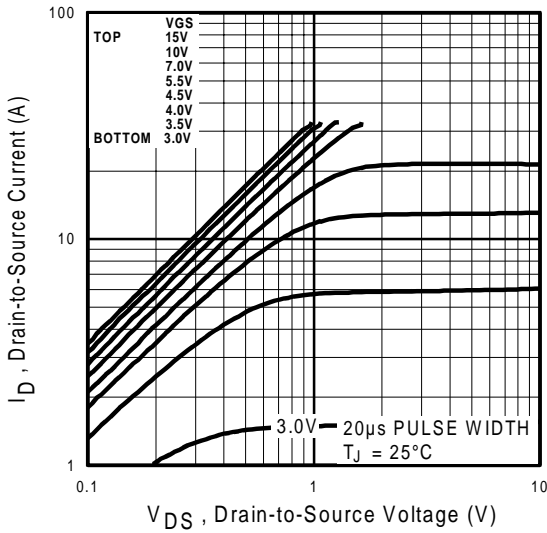

Fig 1. Typical Output Characteristics

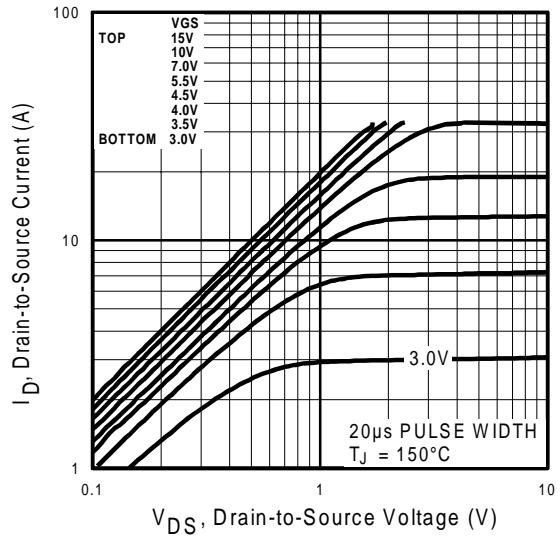

Fig 2. Typical Output Characteristics

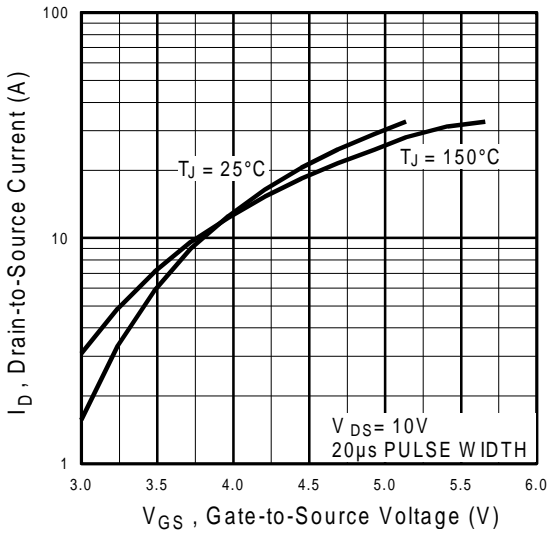

Fig 3. Typical Transfer Characteristics

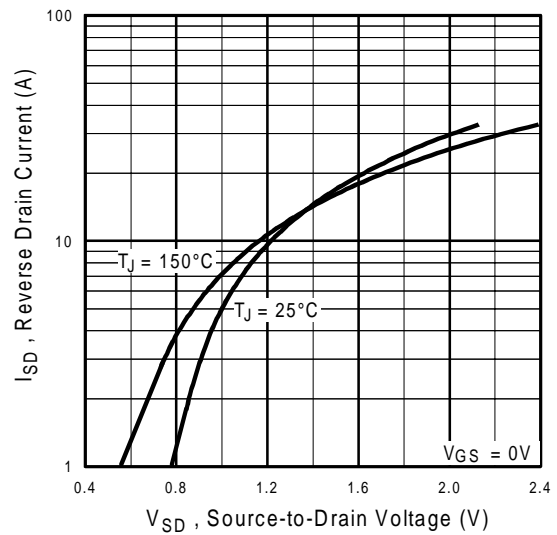

Fig 4. Typical Source-Drain Diode Forward Voltage

IRF7421D1

International
IR Rectifier

Power Mosfet Characteristics

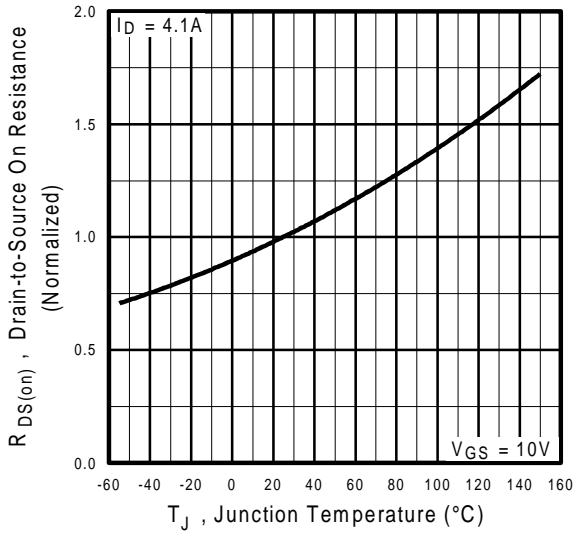

Fig 5. Normalized On-Resistance Vs. Temperature

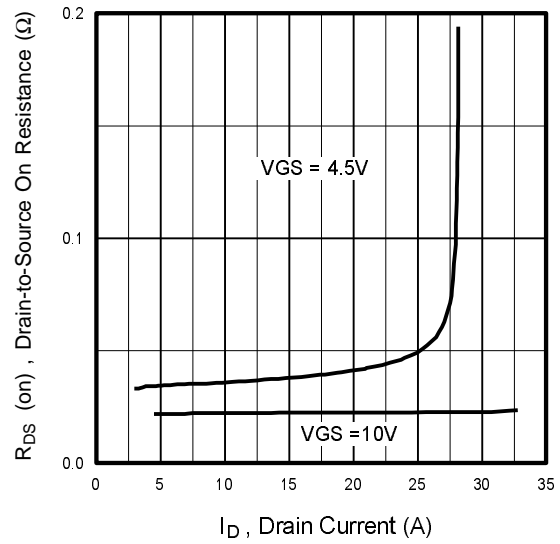

Fig 6. Typical On-Resistance Vs. Drain Current

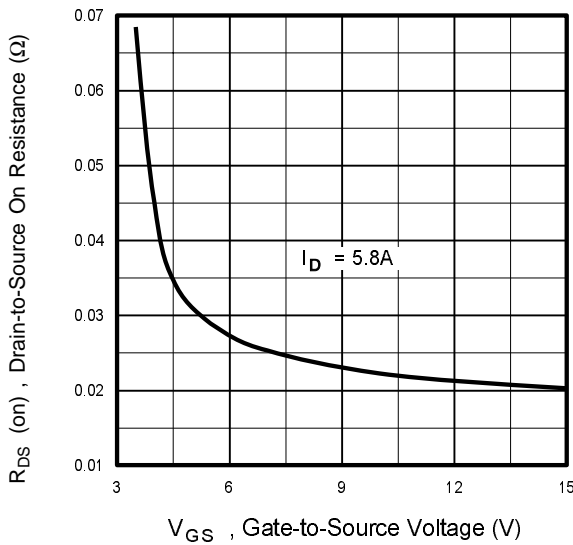

Fig 7. Typical On-Resistance Vs. Gate Voltage

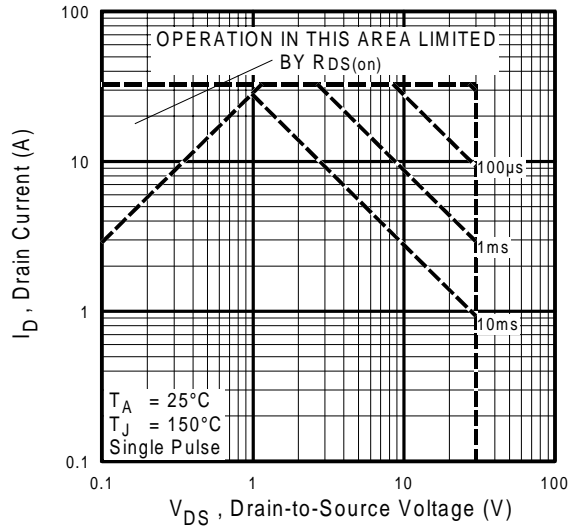

Fig 8. Maximum Safe Operating Area

Power Mosfet Characteristics

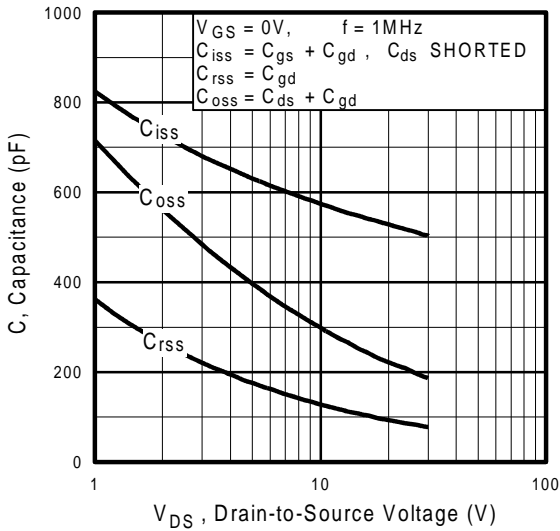

Fig 9. Typical Capacitance Vs. Drain-to-Source Voltage

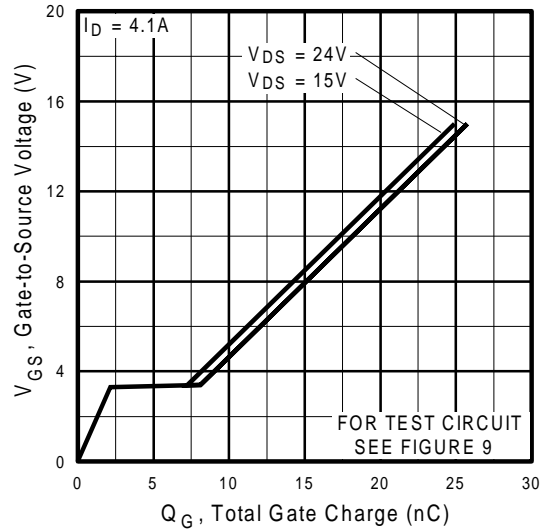

Fig 10. Typical Gate Charge Vs. Gate-to-Source Voltage

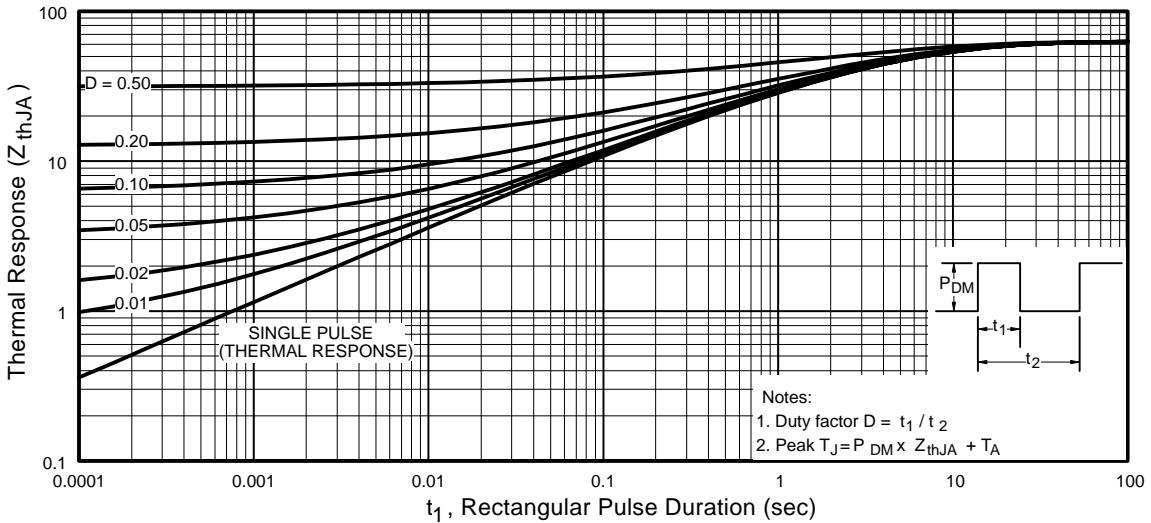

Fig 11. Maximum Effective Transient Thermal Impedance, Junction-to-Ambient

Schottky Diode Characteristics

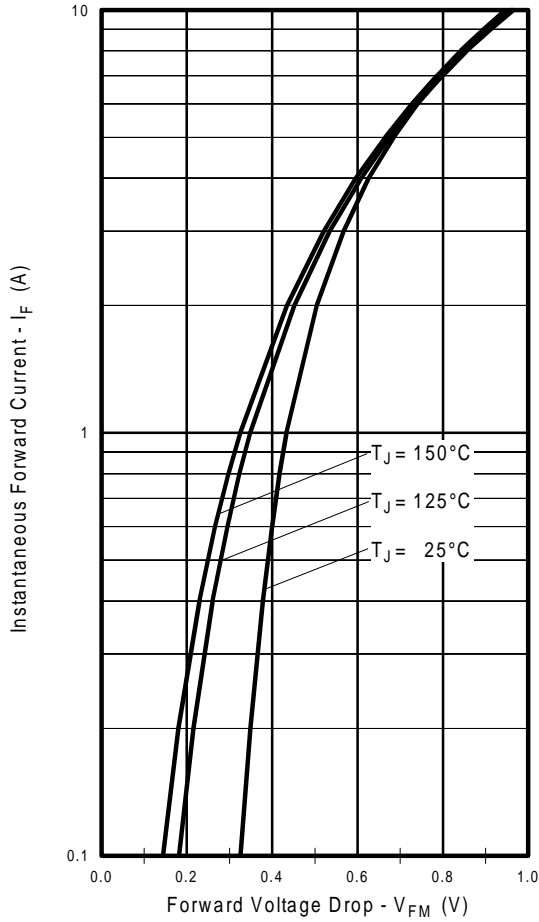

Fig. 12 -Typical Forward Voltage Drop Characteristics

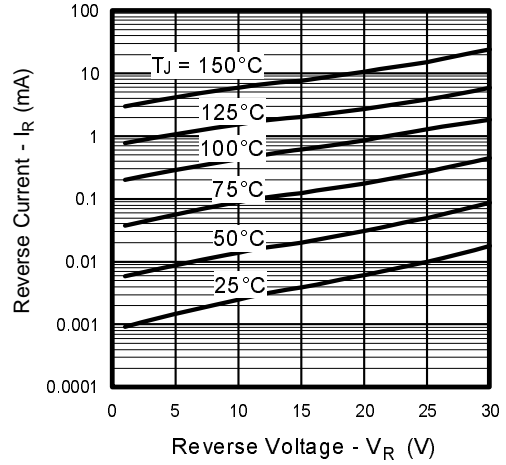

Fig. 13 - Typical Values of Reverse Current Vs. Reverse Voltage

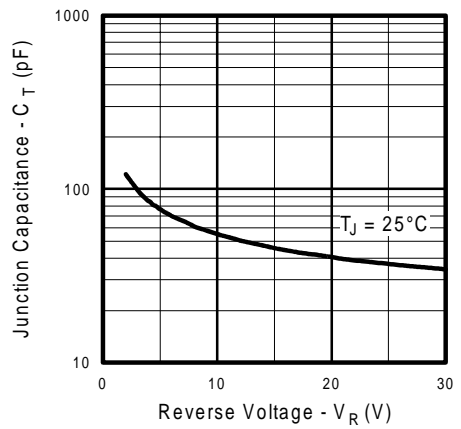
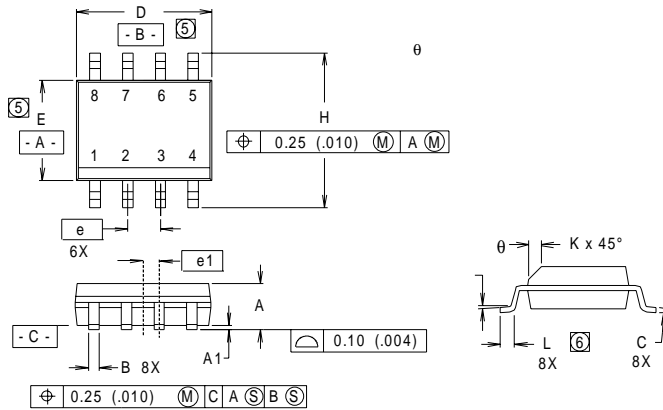

Fig.14 - Typical Junction Capacitance Vs. Reverse Voltage

SO-8 Package Details



DIM	INCHES		MILLIMETERS	
	MIN	MAX	MIN	MAX
A	.0532	.0688	1.35	1.75
A1	.0040	.0098	0.10	0.25
B	.014	.018	0.36	0.46
C	.0075	.0098	0.19	0.25
D	.189	.196	4.80	4.98
E	.150	.157	3.81	3.99
e	.050 BASIC		1.27 BASIC	
e1	.025 BASIC		0.635 BASIC	
H	.2284	.2440	5.80	6.20
K	.011	.019	0.28	0.48
L	0.16	.050	0.41	1.27
θ	0°	8°	0°	8°

RECOMMENDED FOOTPRINT

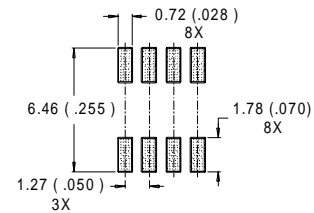

NOTES:

1. DIMENSIONING AND TOLERANCING PER ANSI Y14.5M-1982.
2. CONTROLLING DIMENSION : INCH.
3. DIMENSIONS ARE SHOWN IN MILLIMETERS (INCHES).
4. OUTLINE CONFORMS TO JEDEC OUTLINE MS-012AA.
- 5 DIMENSION DOES NOT INCLUDE MOLD PROTRUSIONS
 MOLD PROTRUSIONS NOT TO EXCEED 0.25 (.006).
- 6 DIMENSIONS IS THE LENGTH OF LEAD FOR SOLDERING TO A SUBSTRATE..

**Part Marking
 (IRF7101 example)**

EXAMPLE: THIS IS AN IRF7101

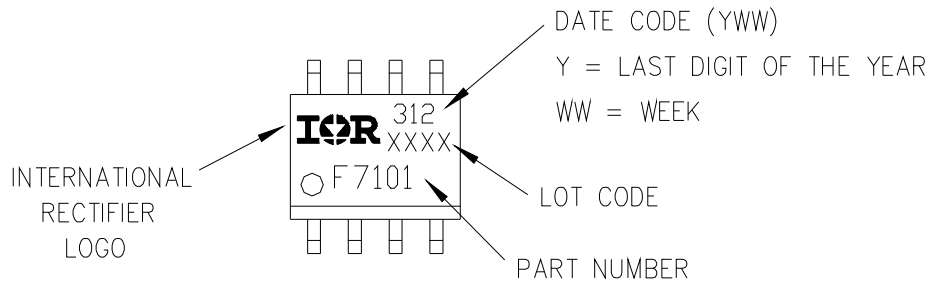

IRF7421D1

International
IR Rectifier

Tape and Reel

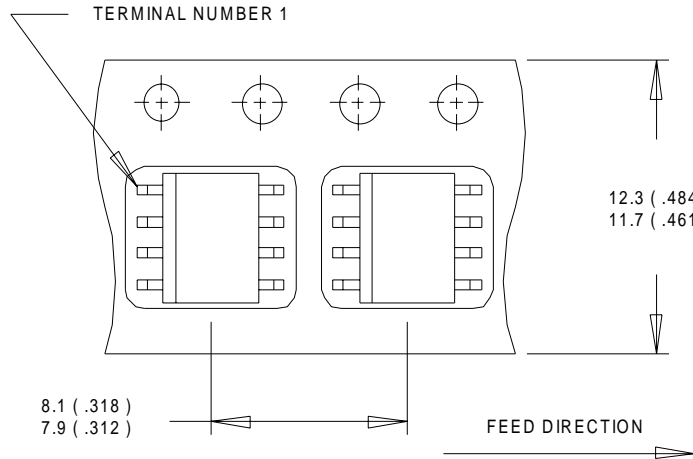

NOTES:

1. CONTROLLING DIMENSION : MILLIMETER.
2. ALL DIMENSIONS ARE SHOWN IN MILLIMETERS(INCHES).
3. OUTLINE CONFORMS TO EIA-481 & EIA-541.

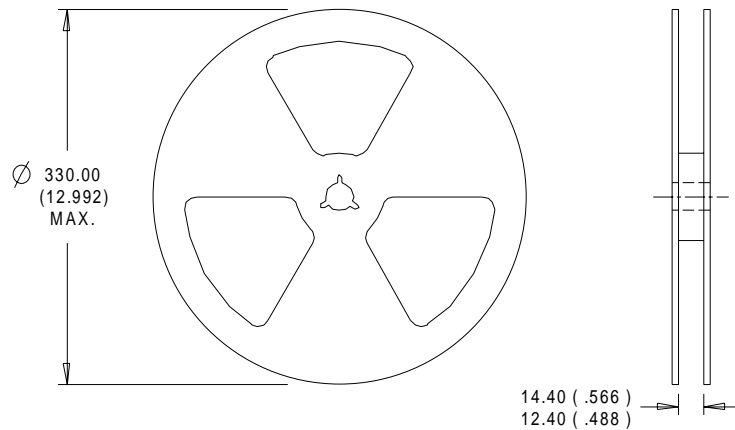

NOTES :

1. CONTROLLING DIMENSION : MILLIMETER.
2. OUTLINE CONFORMS TO EIA-481 & EIA-541.

International
IR Rectifier

WORLD HEADQUARTERS: 233 Kansas St., El Segundo, California 90245, Tel: (310) 322 3331
EUROPEAN HEADQUARTERS: Hurst Green, Oxted, Surrey RH8 9BB, UK Tel: ++ 44 1883 732020

IR CANADA: 15 Lincoln Court, Brampton, Ontario L6T 3Z2, Tel: (905) 453 2200

IR GERMANY: Saalburgstrasse 157, 61350 Bad Homburg Tel: ++ 49 6172 96590

IR ITALY: Via Liguria 49, 10071 Borgaro, Torino Tel: ++ 39 11 451 0111

IR FAR EAST: 171 (K&H Bldg.) 30-4 Nishi-ikebukuro 3-chome, Toshima-ku, Tokyo Japan Tel: 81 33 983 0086

IR SOUTHEAST ASIA: 315 Outram Road, #10-02 Tan Boon Liat Building, Singapore 16907 Tel: 65 221 8371

Data and specifications subject to change without notice.

8/98