

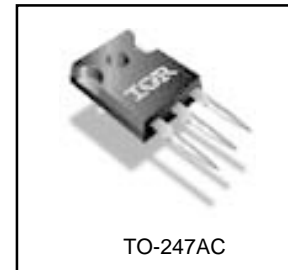
**Applications**

- Hard Switching Primary or PFC Switch
- Switch Mode Power Supply (SMPS)
- Uninterruptible Power Supply
- High Speed Power Switching
- Motor Drive

<b>V<sub>DSS</sub></b>	<b>R<sub>DS(on)</sub> typ.</b>	<b>I<sub>D</sub></b>
<b>600V</b>	<b>180mΩ</b>	<b>27A</b>

**Benefits**

- Low Gate Charge Qg results in Simple Drive Requirement
- Improved Gate, Avalanche and Dynamic dv/dt Ruggedness
- Fully Characterized Capacitance and Avalanche Voltage and Current
- Enhanced Body Diode dv/dt Capability



**Absolute Maximum Ratings**

	Parameter	Max.	Units
I <sub>D</sub> @ T <sub>C</sub> = 25°C	Continuous Drain Current, V <sub>GS</sub> @ 10V	27	A
I <sub>D</sub> @ T <sub>C</sub> = 100°C	Continuous Drain Current, V <sub>GS</sub> @ 10V	18	
I <sub>DM</sub>	Pulsed Drain Current ①	110	
P <sub>D</sub> @ T <sub>C</sub> = 25°C	Power Dissipation	500	W
	Linear Derating Factor	4.0	W/°C
V <sub>GS</sub>	Gate-to-Source Voltage	± 30	V
dv/dt	Peak Diode Recovery dv/dt ③	13	V/ns
T <sub>J</sub>	Operating Junction and Storage Temperature Range	-55 to + 150	°C
T <sub>STG</sub>			
	Soldering Temperature, for 10 seconds (1.6mm from case )	300	
	Mounting torque, 6-32 or M3 screw	10 lbf•in (1.1N•m)	

**Avalanche Characteristics**

Symbol	Parameter	Typ.	Max.	Units
E <sub>AS</sub>	Single Pulse Avalanche Energy②	—	530	mJ
I <sub>AR</sub>	Avalanche Current①	—	27	A
E <sub>AR</sub>	Repetitive Avalanche Energy①	—	50	mJ

**Thermal Resistance**

Symbol	Parameter	Typ.	Max.	Units
R <sub>θJC</sub>	Junction-to-Case	—	0.29	°C/W
R <sub>θCS</sub>	Case-to-Sink, Flat, Greased Surface	0.24	—	
R <sub>θJA</sub>	Junction-to-Ambient	—	40	

# IRFP27N60K

International  
**IR** Rectifier

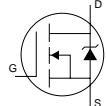
## Static @ $T_J = 25^\circ\text{C}$ (unless otherwise specified)

Symbol	Parameter	Min.	Typ.	Max.	Units	Conditions
$V_{(BR)DSS}$	Drain-to-Source Breakdown Voltage	600	—	—	V	$V_{GS} = 0V, I_D = 250\mu A$
$\Delta V_{(BR)DSS}/\Delta T_J$	Breakdown Voltage Temp. Coefficient	—	0.64	—	V/°C	Reference to $25^\circ\text{C}, I_D = 1mA$ ⑥
$R_{DS(on)}$	Static Drain-to-Source On-Resistance	—	180	220	mΩ	$V_{GS} = 10V, I_D = 16A$ ④
$V_{GS(th)}$	Gate Threshold Voltage	3.0	—	5.0	V	$V_{DS} = V_{GS}, I_D = 250\mu A$
$I_{DSS}$	Drain-to-Source Leakage Current	—	—	50	μA	$V_{DS} = 600V, V_{GS} = 0V$
		—	—	250		$V_{DS} = 480V, V_{GS} = 0V, T_J = 125^\circ\text{C}$
$I_{GSS}$	Gate-to-Source Forward Leakage	—	—	100	nA	$V_{GS} = 30V$
	Gate-to-Source Reverse Leakage	—	—	-100		$V_{GS} = -30V$

## Dynamic @ $T_J = 25^\circ\text{C}$ (unless otherwise specified)

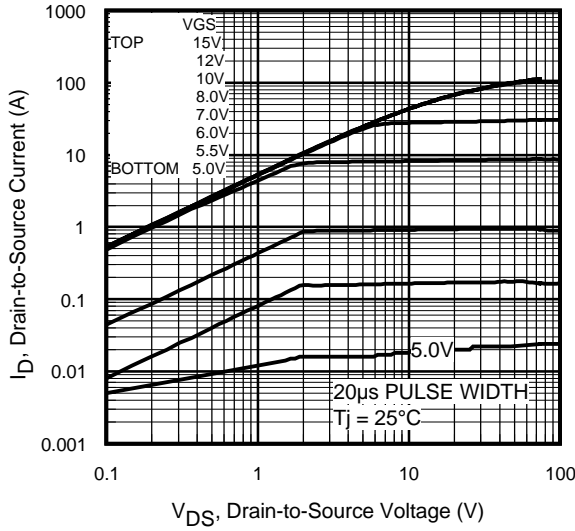
Symbol	Parameter	Min.	Typ.	Max.	Units	Conditions
$g_{fs}$	Forward Transconductance	14	—	—	S	$V_{DS} = 50V, I_D = 16A$
$Q_g$	Total Gate Charge	—	—	180	nC	$I_D = 27A$
$Q_{gs}$	Gate-to-Source Charge	—	—	56		$V_{DS} = 480V$
$Q_{gd}$	Gate-to-Drain ("Miller") Charge	—	—	86		$V_{GS} = 10V, \text{See Fig. 6 and 13}$ ④
$t_{d(on)}$	Turn-On Delay Time	—	27	—	ns	$V_{DD} = 300V$
$t_r$	Rise Time	—	110	—		$I_D = 27A$
$t_{d(off)}$	Turn-Off Delay Time	—	43	—		$R_G = 4.3\Omega$
$t_f$	Fall Time	—	38	—		$V_{GS} = 10V, \text{See Fig. 10}$ ④
$C_{iss}$	Input Capacitance	—	4660	—	pF	$V_{GS} = 0V$
$C_{oss}$	Output Capacitance	—	460	—		$V_{DS} = 25V$
$C_{riss}$	Reverse Transfer Capacitance	—	41	—		$f = 1.0MHz, \text{See Fig. 5}$
$C_{oss}$	Output Capacitance	—	5490	—		$V_{GS} = 0V, V_{DS} = 1.0V, f = 1.0MHz$
$C_{oss}$	Output Capacitance	—	120	—		$V_{GS} = 0V, V_{DS} = 480V, f = 1.0MHz$
$C_{oss \text{ eff.}}$	Effective Output Capacitance	—	250	—		$V_{GS} = 0V, V_{DS} = 0V \text{ to } 480V$ ⑤

## Diode Characteristics

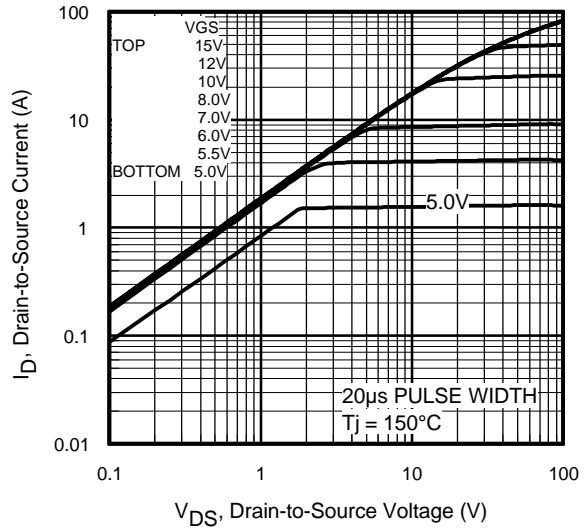
Symbol	Parameter	Min.	Typ.	Max.	Units	Conditions
$I_S$	Continuous Source Current (Body Diode)	—	—	27	A	MOSFET symbol showing the integral reverse p-n junction diode. 
$I_{SM}$	Pulsed Source Current (Body Diode) ①	—	—	110		
$V_{SD}$	Diode Forward Voltage	—	—	1.5	V	$T_J = 25^\circ\text{C}, I_S = 27A, V_{GS} = 0V$ ④
$t_{rr}$	Reverse Recovery Time	—	620	920	ns	$T_J = 25^\circ\text{C}, I_F = 27A$
$Q_{rr}$	Reverse Recovery Charge	—	11	16	μC	$di/dt = 100A/\mu s$ ④
$I_{RRM}$	Reverse Recovery Current	—	36	53	A	
$t_{on}$	Forward Turn-On Time	Intrinsic turn-on time is negligible (turn-on is dominated by $L_S + L_D$ )				

### Notes:

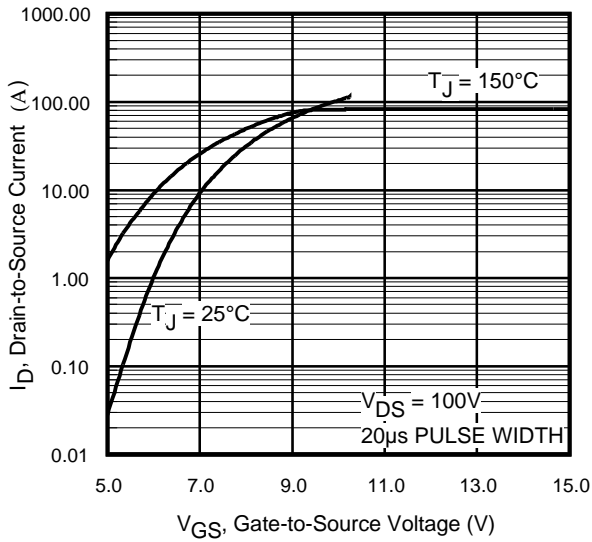
- ① Repetitive rating; pulse width limited by max. junction temperature. (See Fig. 11)
- ② Starting  $T_J = 25^\circ\text{C}$ ,  $L = 1.4mH$ ,  $R_G = 25\Omega$ ,  $I_{AS} = 27A$ ,  $dv/dt = 13V/ns$ . (See Figure 12a)
- ③  $I_{SD} \leq 27A$ ,  $di/dt \leq 390A/\mu s$ ,  $V_{DD} \leq V_{(BR)DSS}$ ,  $T_J \leq 150^\circ\text{C}$ .
- ④ Pulse width  $\leq 300\mu s$ ; duty cycle  $\leq 2\%$ .
- ⑤  $C_{oss \text{ eff.}}$  is a fixed capacitance that gives the same charging time as  $C_{oss}$  while  $V_{DS}$  is rising from 0 to 80%  $V_{DSS}$ .



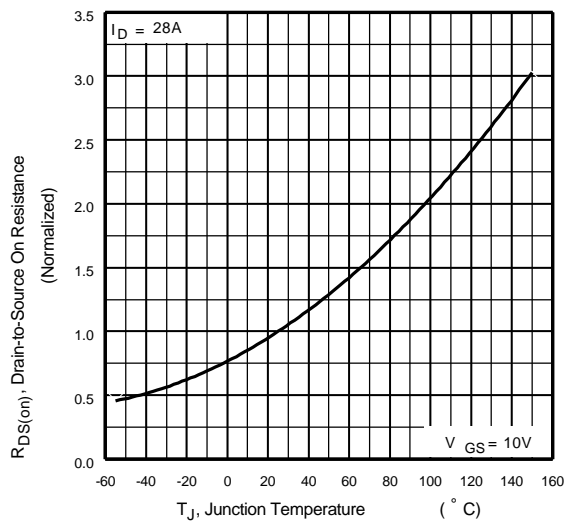
**Fig 1.** Typical Output Characteristics



**Fig 2.** Typical Output Characteristics

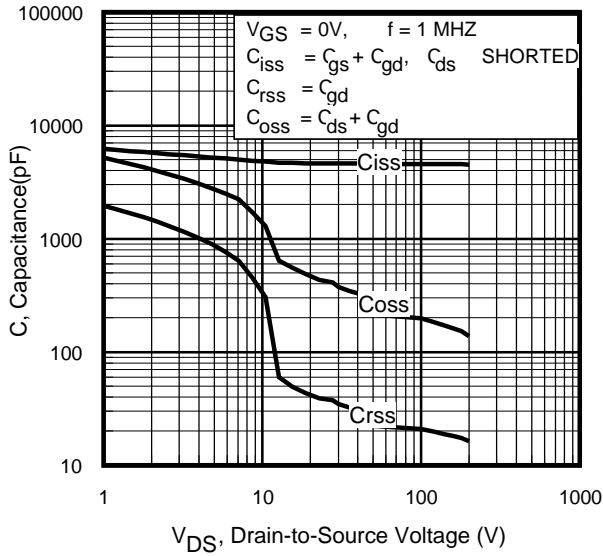


**Fig 3.** Typical Transfer Characteristics

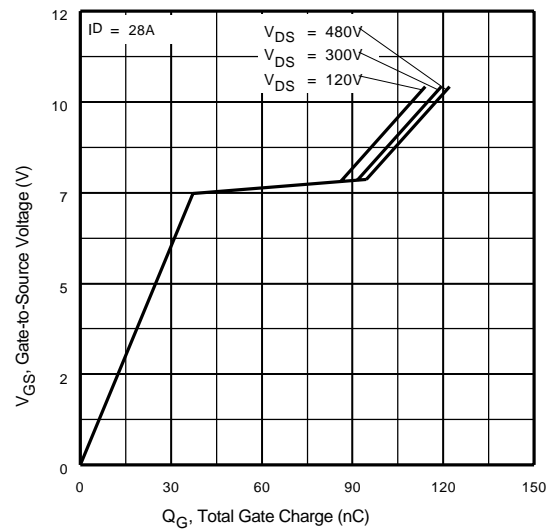


**Fig 4.** Normalized On-Resistance Vs. Temperature

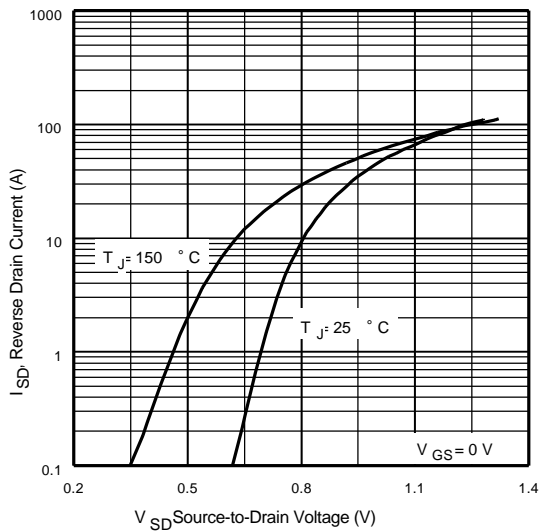
# IRFP27N60K



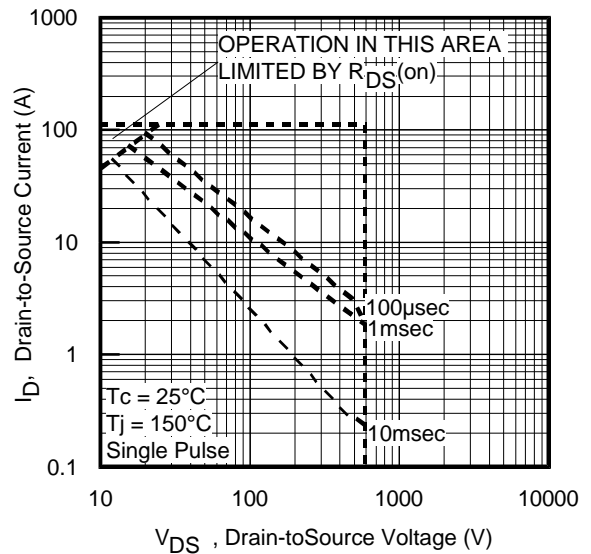
**Fig 5.** Typical Capacitance Vs. Drain-to-Source Voltage



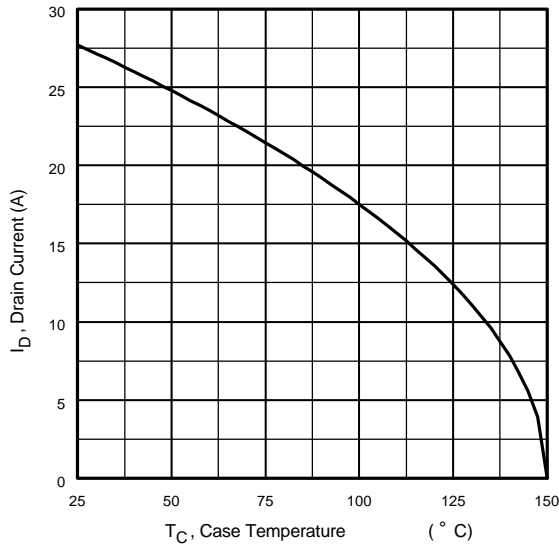
**Fig 6.** Typical Gate Charge Vs. Gate-to-Source Voltage



**Fig 7.** Typical Source-Drain Diode Forward Voltage



**Fig 8.** Maximum Safe Operating Area



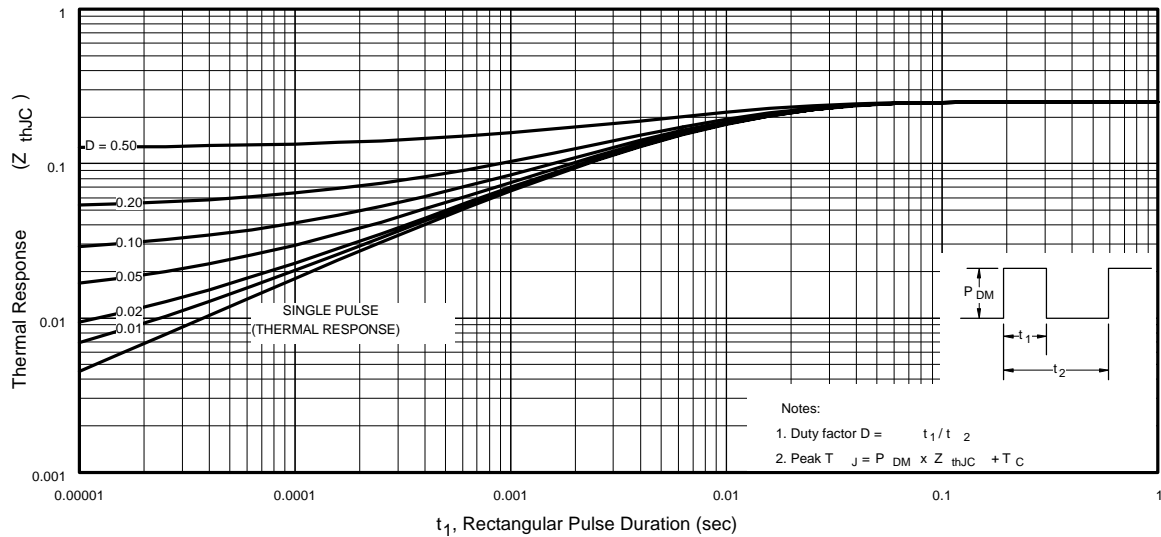
**Fig 9.** Maximum Drain Current Vs. Case Temperature



**Fig 10a.** Switching Time Test Circuit



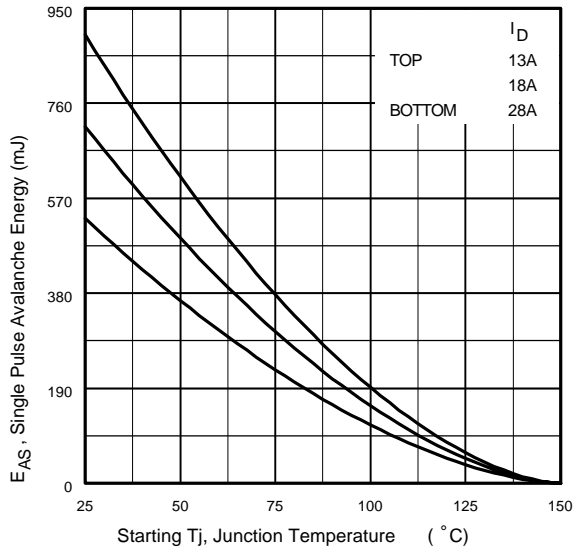
**Fig 10b.** Switching Time Waveforms



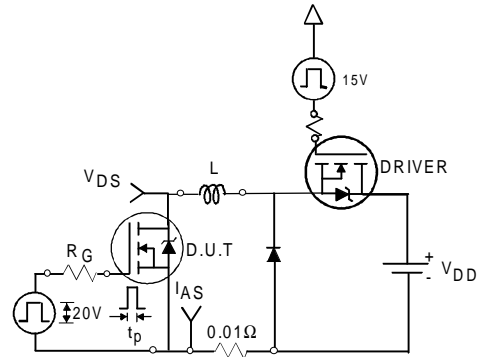
**Fig 11.** Maximum Effective Transient Thermal Impedance, Junction-to-Case

# IRFP27N60K

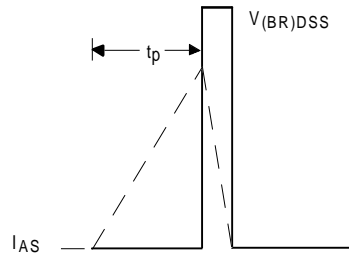
International  
**IR** Rectifier



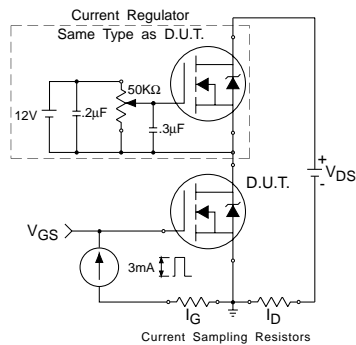
**Fig 12a.** Maximum Avalanche Energy Vs. Drain Current



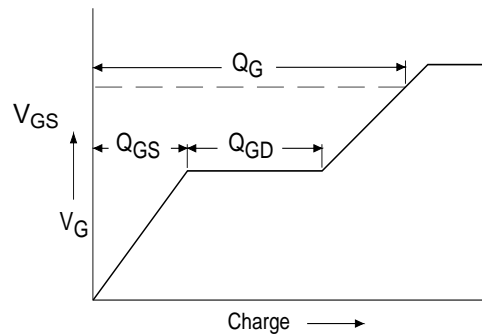
**Fig 12c.** Unclamped Inductive Test Circuit



**Fig 12d.** Unclamped Inductive Waveforms

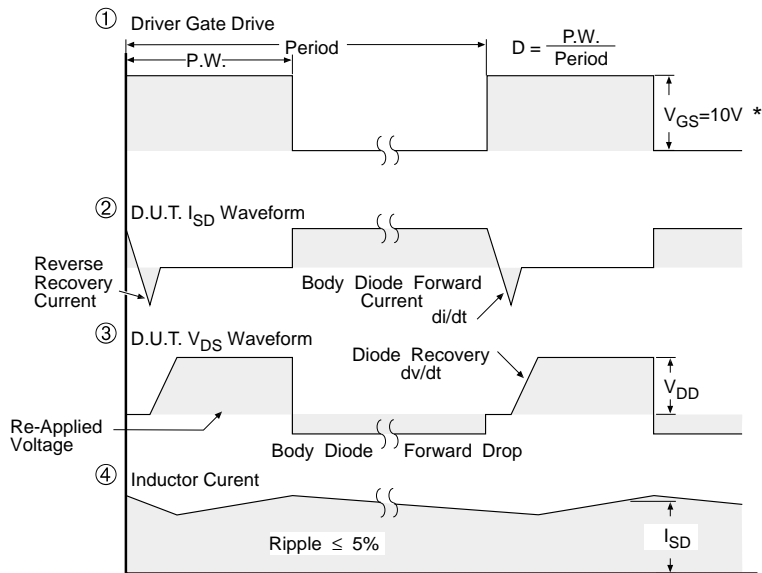
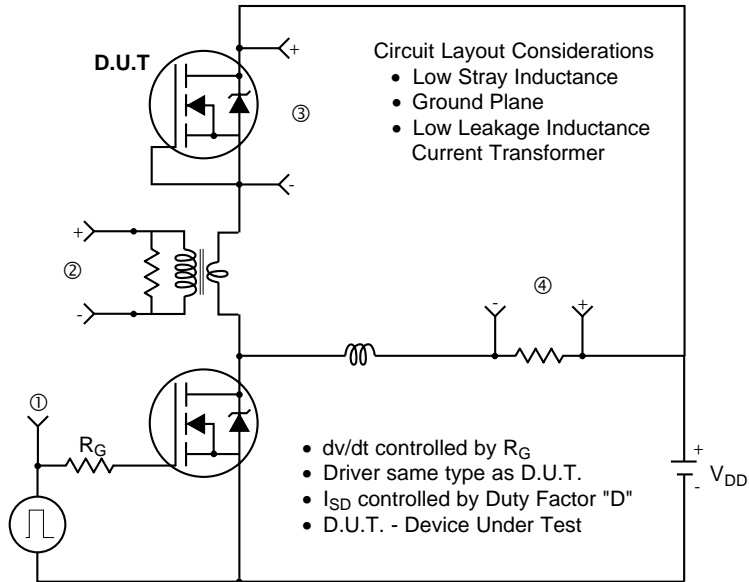


**Fig 13a.** Gate Charge Test Circuit



**Fig 13b.** Basic Gate Charge Waveform

## Peak Diode Recovery dv/dt Test Circuit



\*  $V_{GS} = 5V$  for Logic Level Devices

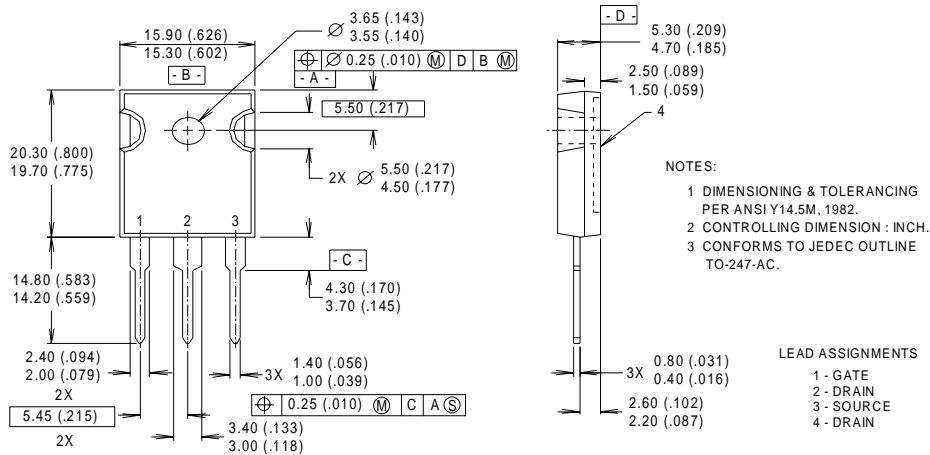
**Fig 14.** For N-Channel HEXFET® Power MOSFETs

# IRFP27N60K

International  
**IR** Rectifier

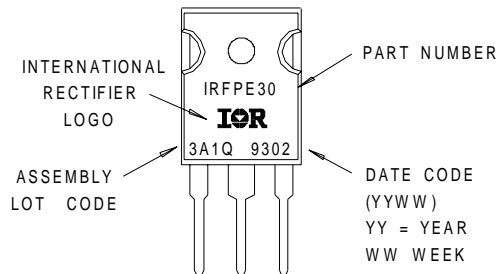
## TO-247AC Package Outline

Dimensions are shown in millimeters (inches)



## TO-247AC Part Marking Information

EXAMPLE : THIS IS AN IRFPE30  
WITH ASSEMBLY  
LOT CODE 3A1Q



Data and specifications subject to change without notice.  
This product has been designed and qualified for the Industrial market.  
Qualification Standards can be found on IR's Web site.

International  
**IR** Rectifier

**IR WORLD HEADQUARTERS:** 233 Kansas St., El Segundo, California 90245, USA Tel: (310) 252-7105  
TAC Fax: (310) 252-7903

Visit us at [www.irf.com](http://www.irf.com) for sales contact information.03/02

[www.irf.com](http://www.irf.com)