

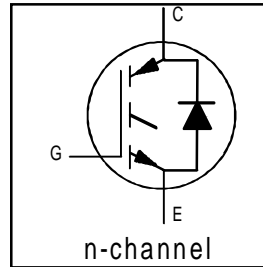
# IRG4BC20FD-S

INSULATED GATE BIPOLAR TRANSISTOR WITH  
ULTRAFAST SOFT RECOVERY DIODE

Fast CoPack IGBT

## Features

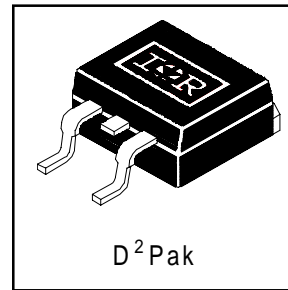
- Fast: Optimized for medium operating frequencies ( 1-5 kHz in hard switching, >20 kHz in resonant mode).
- Generation 4 IGBT design provides tighter parameter distribution and higher efficiency than Generation 3
- IGBT co-packaged with HEXFRED™ ultrafast, ultra-soft-recovery anti-parallel diodes for use in bridge configurations
- Industry standard D<sup>2</sup>Pak package



$V_{CES} = 600V$
$V_{CE(on)} \text{ typ.} = 1.66V$
@ $V_{GE} = 15V, I_C = 9.0A$

## Benefits

- Generation 4 IGBTs offer highest efficiencies available
- IGBTs optimized for specific application conditions
- HEXFRED diodes optimized for performance with IGBTs . Minimized recovery characteristics require less/no snubbing
- Designed to be a "drop-in" replacement for equivalent industry-standard Generation 3 IR IGBTs



## Absolute Maximum Ratings

	Parameter	Max.	Units
$V_{CES}$	Collector-to-Emitter Voltage	600	V
$I_C @ T_C = 25^\circ C$	Continuous Collector Current	16	A
$I_C @ T_C = 100^\circ C$	Continuous Collector Current	9.0	
$I_{CM}$	Pulsed Collector Current ①	64	
$I_{LM}$	Clamped Inductive Load Current ②	64	
$I_F @ T_C = 100^\circ C$	Diode Continuous Forward Current	8.0	
$I_{FM}$	Diode Maximum Forward Current	60	
$V_{GE}$	Gate-to-Emitter Voltage	$\pm 20$	V
$P_D @ T_C = 25^\circ C$	Maximum Power Dissipation	60	W
$P_D @ T_C = 100^\circ C$	Maximum Power Dissipation	24	
$T_J$	Operating Junction and	-55 to +150	$^\circ C$
$T_{STG}$	Storage Temperature Range		

## Thermal Resistance

	Parameter	Typ.	Max.	Units
$R_{\theta JC}$	Junction-to-Case - IGBT	—	2.1	$^\circ C/W$
$R_{\theta JC}$	Junction-to-Case - Diode	—	3.5	
$R_{\theta JA}$	Junction-to-Ambient ( PCB Mounted, steady-state)*	—	80	
Wt	Weight	1.44	—	g (oz)

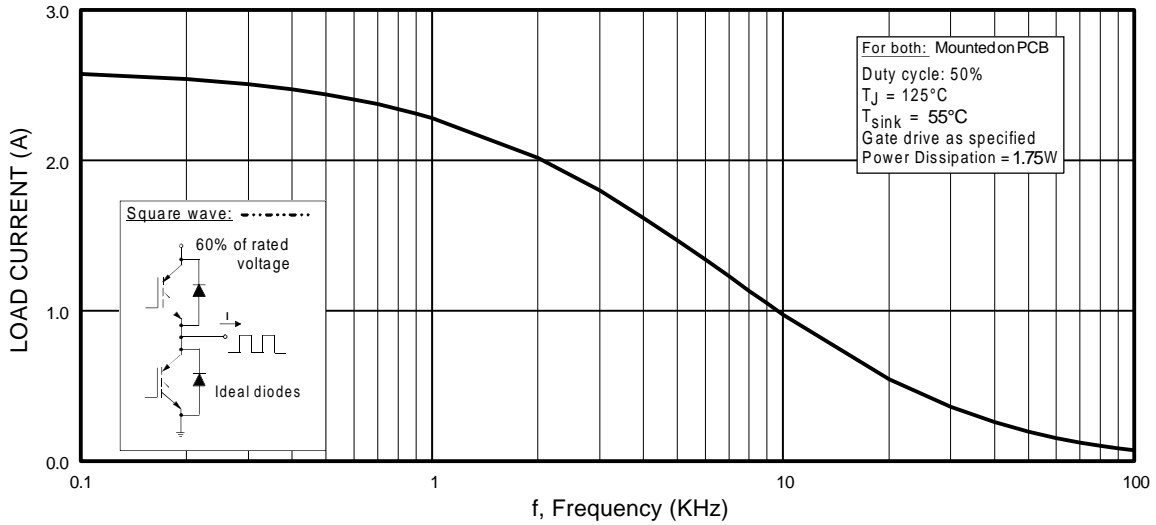
\* When mounted on 1" square PCB (FR-4 or G-10 Material ). For recommended footprint and soldering techniques refer to application note #AN-994.

## Electrical Characteristics @ $T_J = 25^\circ\text{C}$ (unless otherwise specified)

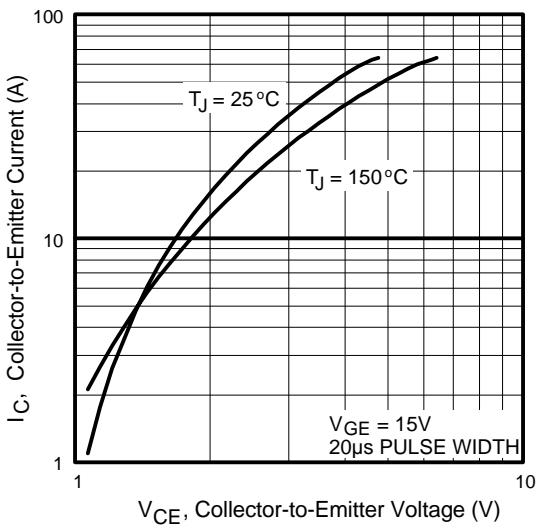
	Parameter	Min.	Typ.	Max.	Units	Conditions
$V_{(BR)CES}$	Collector-to-Emitter Breakdown Voltage <sup>③</sup>	600	—	—	V	$V_{GE} = 0V, I_C = 250\mu A$
$\Delta V_{(BR)CES}/\Delta T_J$	Temperature Coeff. of Breakdown Voltage	—	0.72	—	V/ $^\circ\text{C}$	$V_{GE} = 0V, I_C = 1.0mA$
$V_{CE(on)}$	Collector-to-Emitter Saturation Voltage	—	1.66	2.0	V	$V_{GE} = 15V$ See Fig. 2, 5
		—	2.06	—		
		—	1.76	—		
$V_{GE(th)}$	Gate Threshold Voltage	3.0	—	6.0		$V_{CE} = V_{GE}, I_C = 250\mu A$
$\Delta V_{GE(th)}/\Delta T_J$	Temperature Coeff. of Threshold Voltage	—	-11	—	mV/ $^\circ\text{C}$	$V_{CE} = V_{GE}, I_C = 250\mu A$
$g_{fe}$	Forward Transconductance <sup>④</sup>	2.9	5.1	—	S	$V_{CE} = 100V, I_C = 9.0A$
$I_{CES}$	Zero Gate Voltage Collector Current	—	—	250	$\mu A$	$V_{GE} = 0V, V_{CE} = 600V$ $V_{GE} = 0V, V_{CE} = 600V, T_J = 150^\circ\text{C}$
		—	—	1700		
$V_{FM}$	Diode Forward Voltage Drop	—	1.4	1.7	V	See Fig. 13
		—	1.3	1.6		
$I_{GES}$	Gate-to-Emitter Leakage Current	—	—	$\pm 100$	nA	$V_{GE} = \pm 20V$

## Switching Characteristics @ $T_J = 25^\circ\text{C}$ (unless otherwise specified)

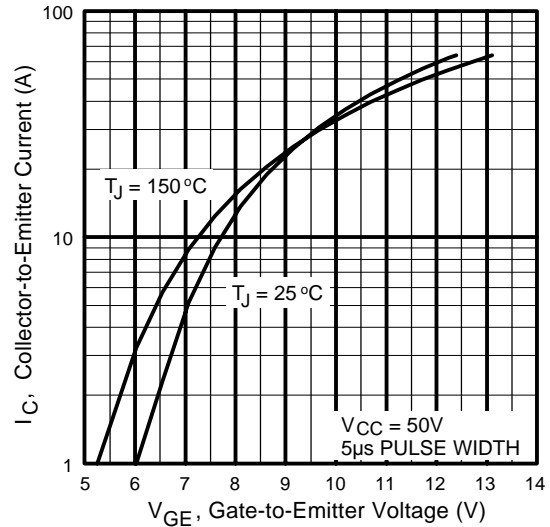
	Parameter	Min.	Typ.	Max.	Units	Conditions
$Q_g$	Total Gate Charge (turn-on)	—	27	40	nC	$I_C = 9.0A$ $V_{CC} = 400V$ $V_{GE} = 15V$ See Fig. 8
$Q_{ge}$	Gate - Emitter Charge (turn-on)	—	4.2	6.2		
$Q_{gc}$	Gate - Collector Charge (turn-on)	—	9.9	15		
$t_{d(on)}$	Turn-On Delay Time	—	43	—	ns	$T_J = 25^\circ\text{C}$ $I_C = 9.0A, V_{CC} = 480V$ $V_{GE} = 15V, R_G = 50\Omega$ Energy losses include "tail" and diode reverse recovery. See Fig. 9, 10, 18
$t_r$	Rise Time	—	20	—		
$t_{d(off)}$	Turn-Off Delay Time	—	240	360		
$t_f$	Fall Time	—	150	220		
$E_{on}$	Turn-On Switching Loss	—	0.25	—	mJ	See Fig. 10, 11, 18
$E_{off}$	Turn-Off Switching Loss	—	0.64	—		
$E_{ts}$	Total Switching Loss	—	0.89	1.3		
$t_{d(on)}$	Turn-On Delay Time	—	41	—	ns	$T_J = 150^\circ\text{C}$ , $I_C = 9.0A, V_{CC} = 480V$ $V_{GE} = 15V, R_G = 50\Omega$ Energy losses include "tail" and diode reverse recovery.
$t_r$	Rise Time	—	22	—		
$t_{d(off)}$	Turn-Off Delay Time	—	320	—		
$t_f$	Fall Time	—	290	—		
$E_{ts}$	Total Switching Loss	—	1.35	—	mJ	
$L_E$	Internal Emitter Inductance	—	7.5	—	nH	Measured 5mm from package
$C_{ies}$	Input Capacitance	—	540	—	pF	$V_{GE} = 0V$ $V_{CC} = 30V$ $f = 1.0MHz$ See Fig. 7
$C_{oes}$	Output Capacitance	—	37	—		
$C_{res}$	Reverse Transfer Capacitance	—	7.0	—		
$t_{rr}$	Diode Reverse Recovery Time	—	37	55	ns	See Fig. 14 $T_J = 25^\circ\text{C}$ $T_J = 125^\circ\text{C}$
		—	55	90		
$I_{rr}$	Diode Peak Reverse Recovery Current	—	3.5	5.0	A	See Fig. 15 $T_J = 25^\circ\text{C}$ $T_J = 125^\circ\text{C}$
		—	4.5	8.0		
$Q_{rr}$	Diode Reverse Recovery Charge	—	65	138	nC	See Fig. 16 $T_J = 25^\circ\text{C}$ $T_J = 125^\circ\text{C}$
		—	124	360		
$di_{(rec)M}/dt$	Diode Peak Rate of Fall of Recovery During $t_b$	—	240	—	A/ $\mu s$	See Fig. 17 $T_J = 25^\circ\text{C}$ $T_J = 125^\circ\text{C}$
		—	210	—		



**Fig. 1 - Typical Load Current vs. Frequency**  
(Load Current =  $I_{RMS}$  of fundamental)

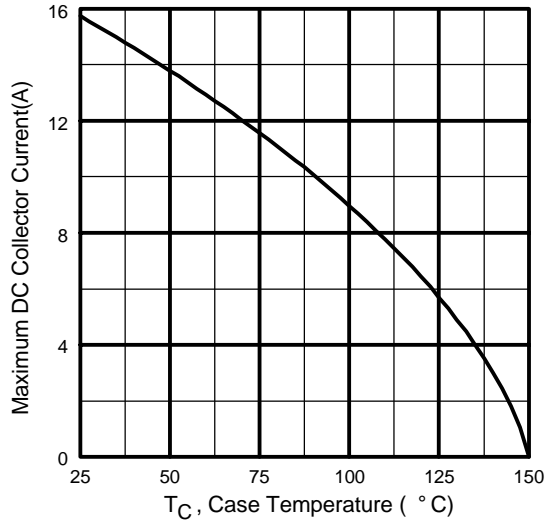


**Fig. 2 - Typical Output Characteristics**  
www.irf.com

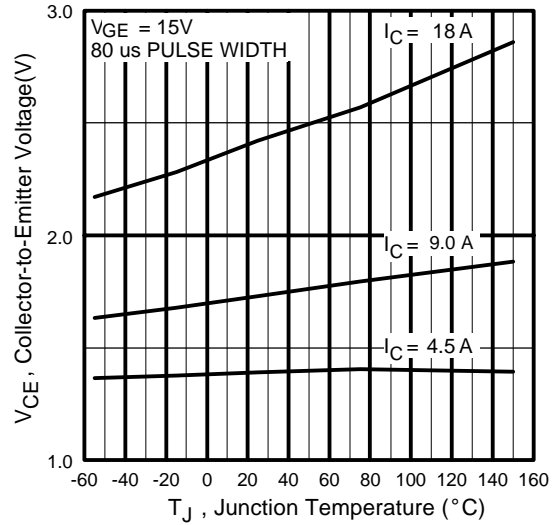


**Fig. 3 - Typical Transfer Characteristics**

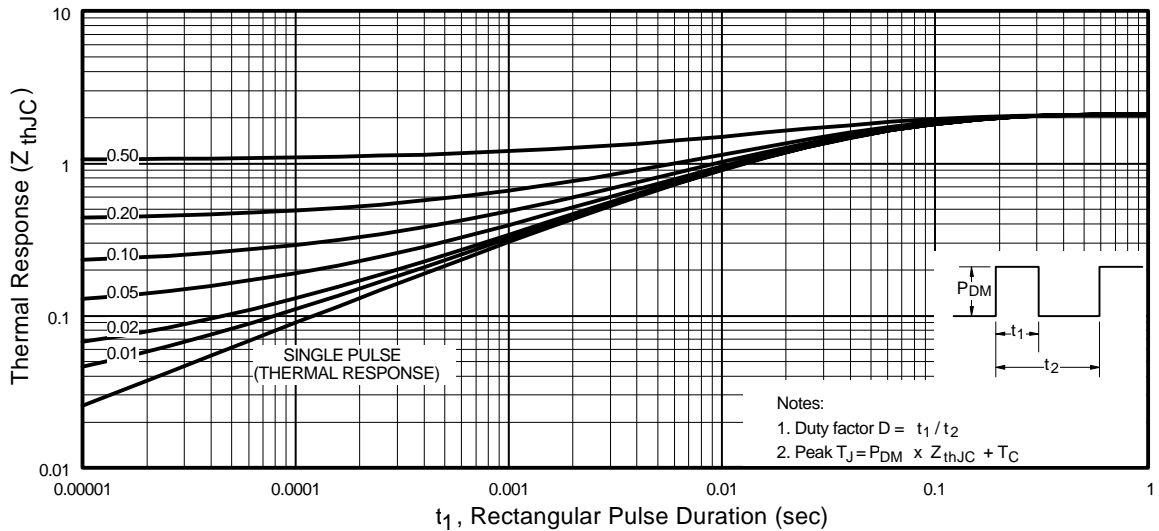
# IRG4BC20FD-S



**Fig. 4** - Maximum Collector Current vs. Case Temperature

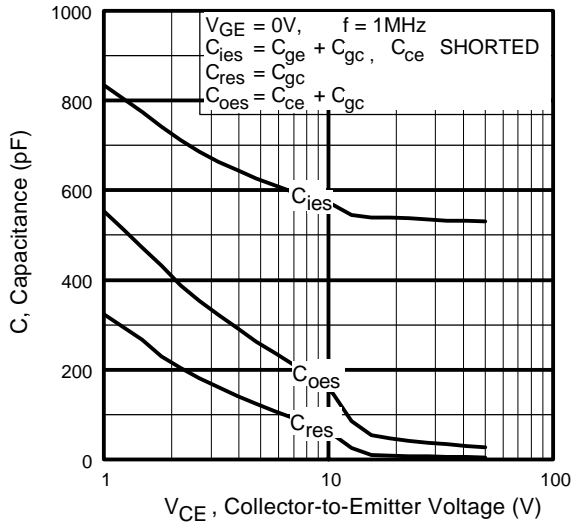


**Fig. 5** - Typical Collector-to-Emitter Voltage vs. Junction Temperature

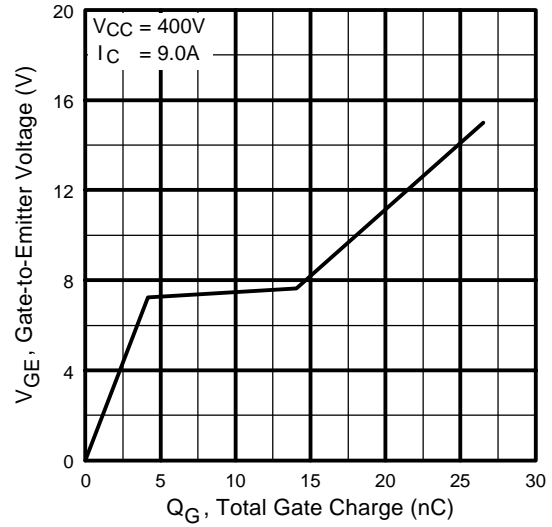


**Fig. 6** - Maximum Effective Transient Thermal Impedance, Junction-to-Case

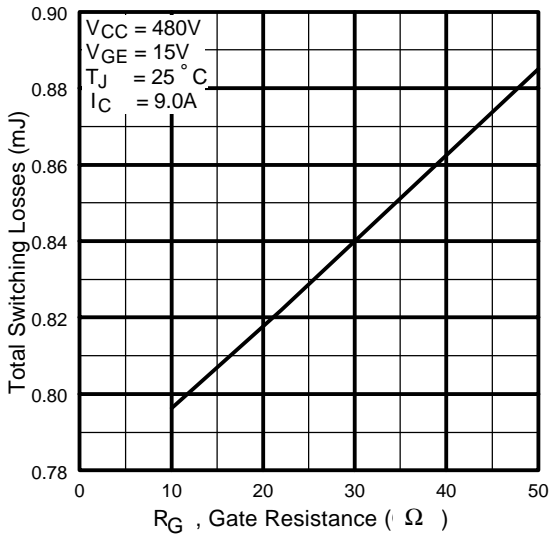
# IRG4BC20FD-S



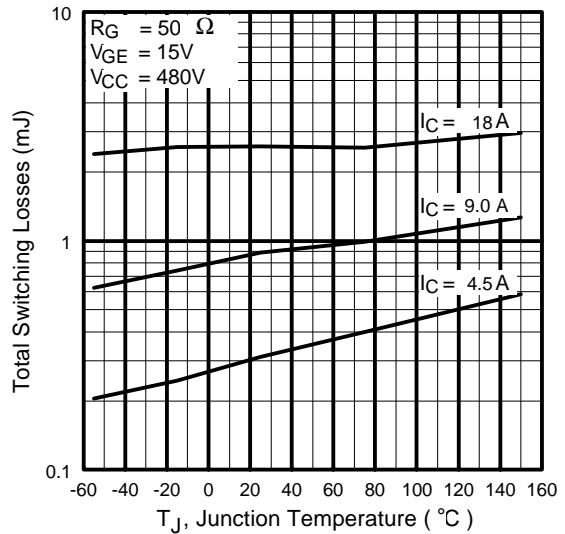
**Fig. 7** - Typical Capacitance vs. Collector-to-Emitter Voltage



**Fig. 8** - Typical Gate Charge vs. Gate-to-Emitter Voltage



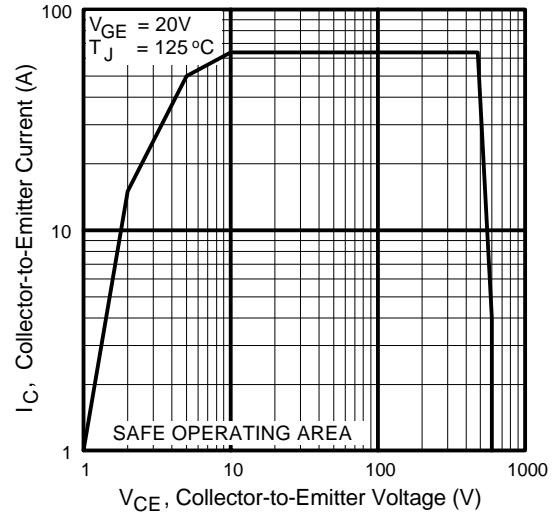
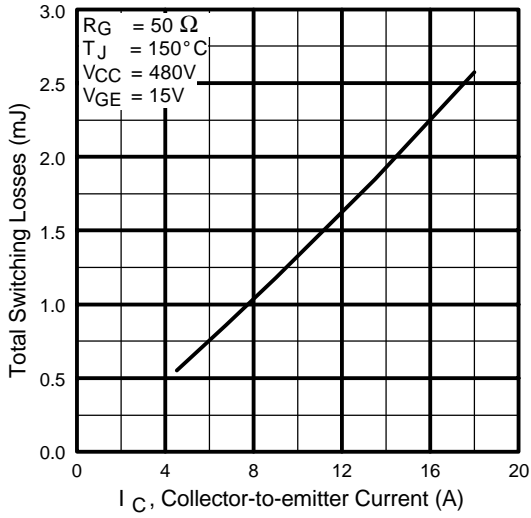
**Fig. 9** - Typical Switching Losses vs. Gate Resistance



**Fig. 10** - Typical Switching Losses vs. Junction Temperature

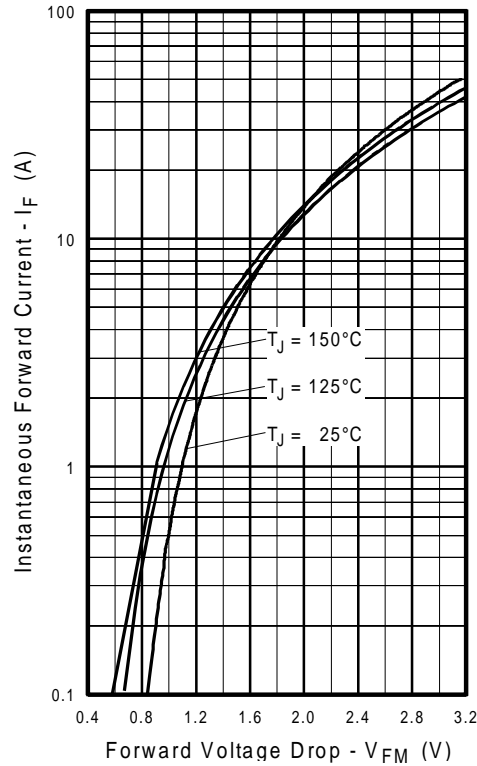
# IRG4BC20FD-S

International  
**IR** Rectifier



**Fig. 11** - Typical Switching Losses vs. Collector-to-Emitter Current

**Fig. 12** - Turn-Off SOA



**Fig. 13** - Maximum Forward Voltage Drop vs. Instantaneous Forward Current

# IRG4BC20FD-S

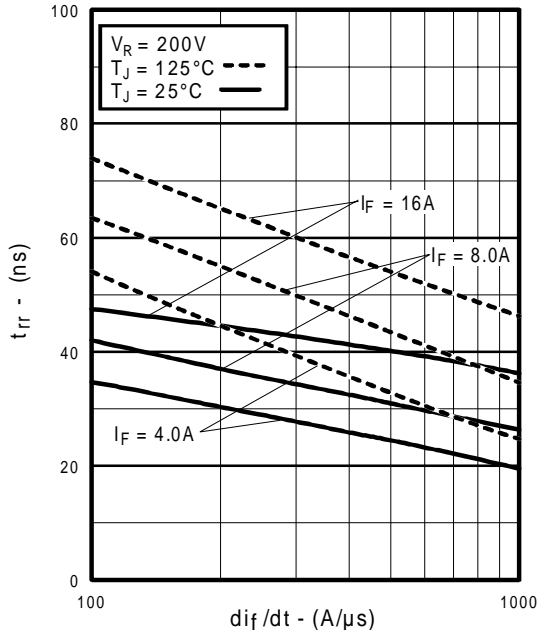


Fig. 14 - Typical Reverse Recovery vs.  $di_f/dt$

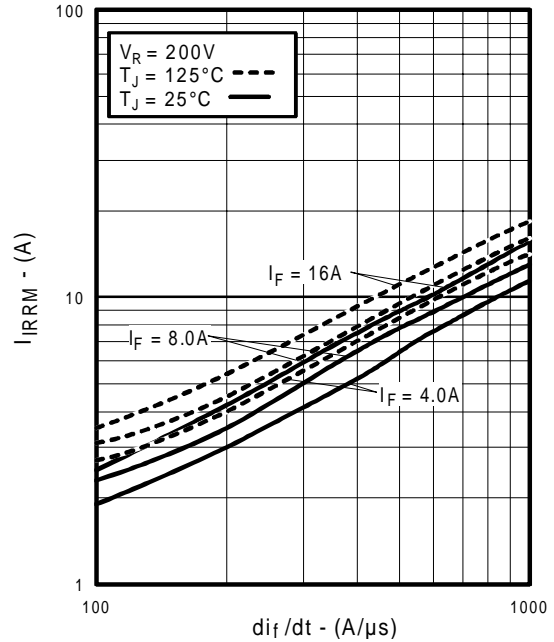


Fig. 15 - Typical Recovery Current vs.  $di_f/dt$

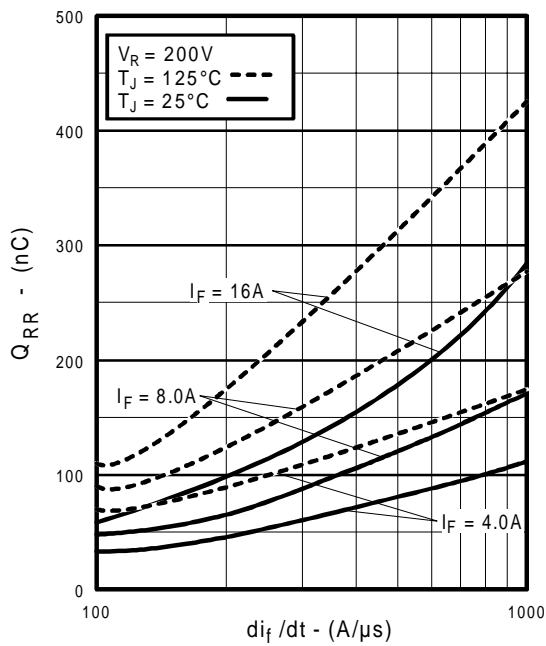


Fig. 16 - Typical Stored Charge vs.  $di_f/dt$

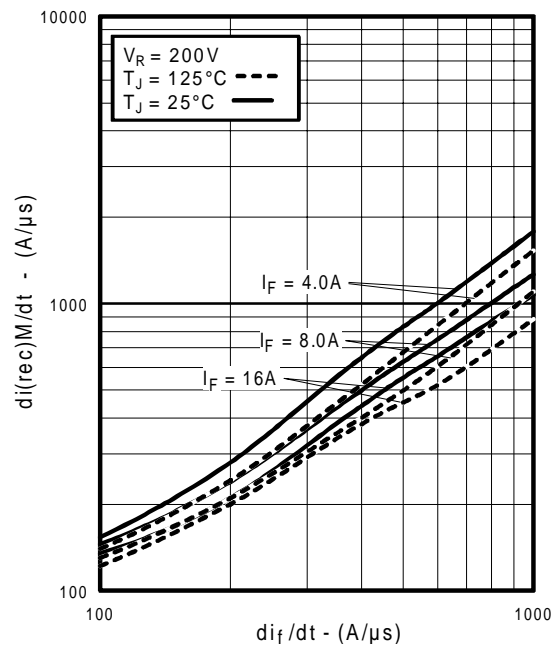
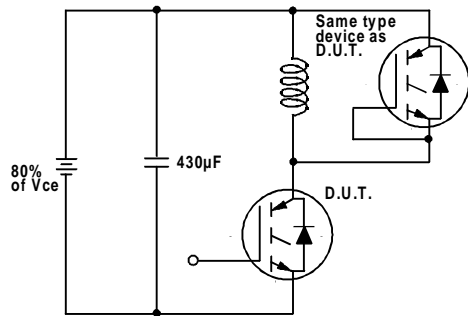
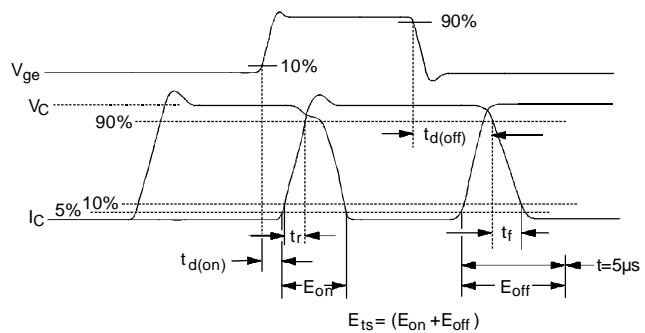


Fig. 17 - Typical  $di_{(rec)M}/dt$  vs.  $di_f/dt$

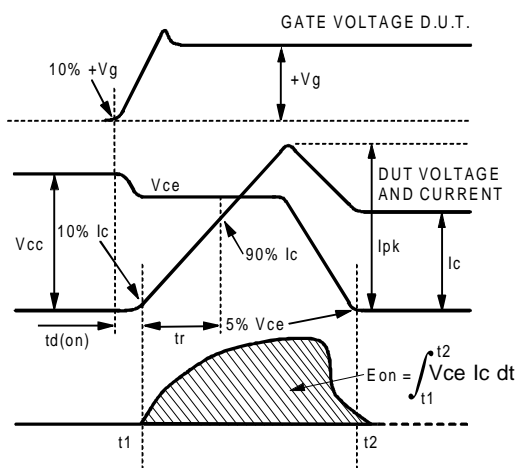
# IRG4BC20FD-S



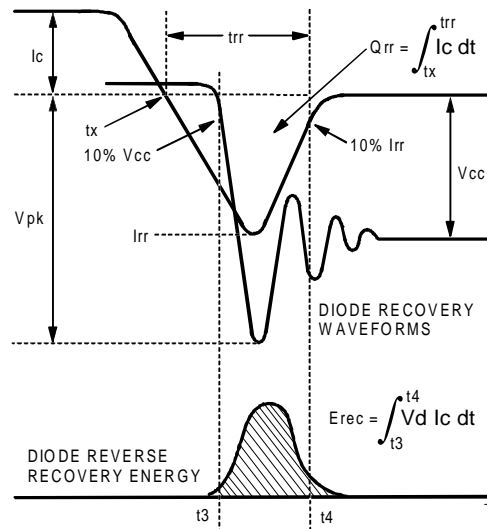
**Fig. 18a** - Test Circuit for Measurement of  $I_{LM}$ ,  $E_{on}$ ,  $E_{off}(\text{diode})$ ,  $t_{rr}$ ,  $Q_{rr}$ ,  $I_{rr}$ ,  $t_{d(on)}$ ,  $t_r$ ,  $t_{d(off)}$ ,  $t_f$



**Fig. 18b** - Test Waveforms for Circuit of Fig. 18a, Defining  $E_{off}$ ,  $t_{d(off)}$ ,  $t_f$



**Fig. 18c** - Test Waveforms for Circuit of Fig. 18a, Defining  $E_{on}$ ,  $t_{d(on)}$ ,  $t_r$



**Fig. 18d** - Test Waveforms for Circuit of Fig. 18a, Defining  $E_{rec}$ ,  $t_{rr}$ ,  $Q_{rr}$ ,  $I_{rr}$



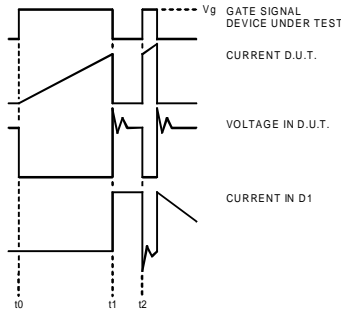


Figure 18e. Macro Waveforms for Figure 18a's Test Circuit

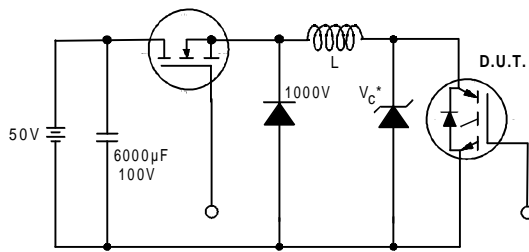


Figure 19. Clamped Inductive Load Test Circuit

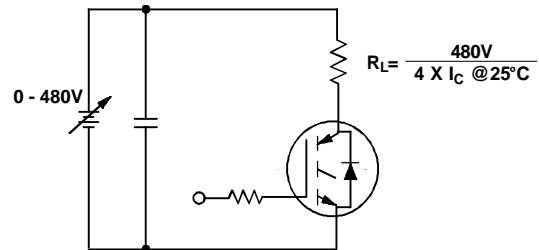
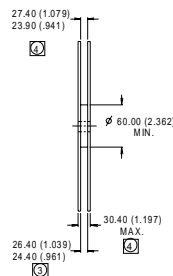
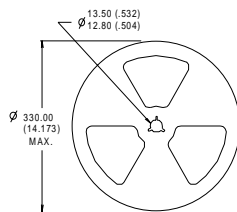
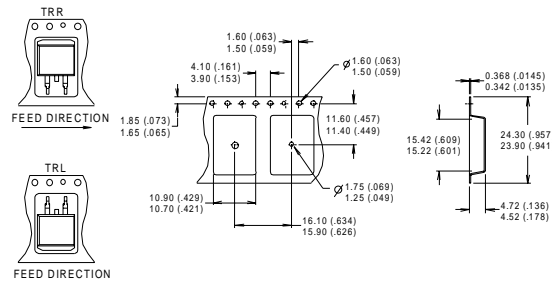


Figure 20. Pulsed Collector Current Test Circuit

## Tape & Reel Information

### D<sup>2</sup>Pak



- NOTES:  
 1. CONFORMS TO EIA-418.  
 2. CONTROLLING DIMENSION: MILLIMETER.  
 3. DIMENSION MEASURED @ HUB.  
 4. INCLUDES FLANGE DISTORTION @ OUTER EDGE.

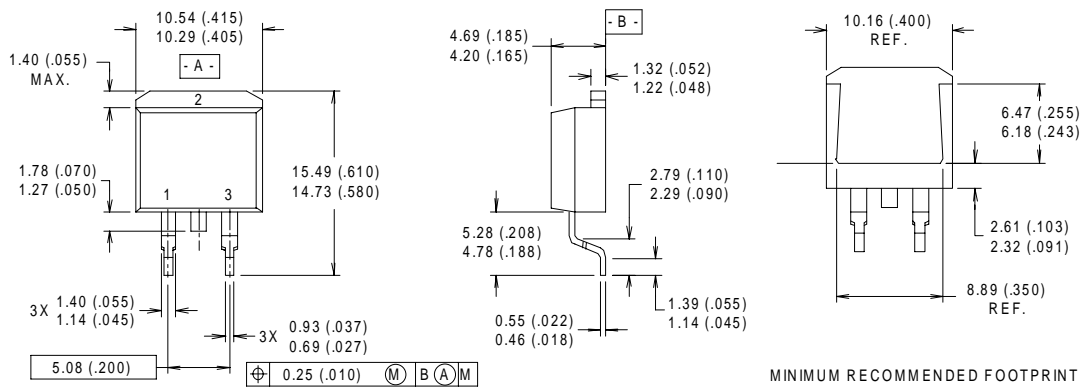
# IRG4BC20FD-S

International  
**IR** Rectifier

## Notes:

- ① Repetitive rating:  $V_{GE}=20V$ ; pulse width limited by maximum junction temperature (figure 20)
- ②  $V_{CC}=80\%(V_{CES})$ ,  $V_{GE}=20V$ ,  $L=10\mu H$ ,  $R_G = 50\Omega$  (figure 19)
- ③ Pulse width  $\leq 80\mu s$ ; duty factor  $\leq 0.1\%$ .
- ④ Pulse width  $5.0\mu s$ , single shot.

## D<sup>2</sup>Pak Package Outline



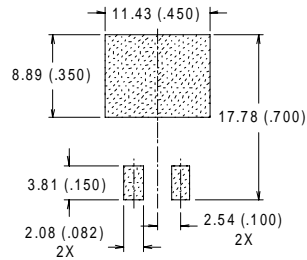
### NOTES:

- 1 DIMENSIONS AFTER SOLDER DIP.
- 2 DIMENSIONING & TOLERANCING PER ANS IY 14.5M, 1982.
- 3 CONTROLLING DIMENSION : INCH.
- 4 HEATSINK & LEAD DIMENSIONS DO NOT INCLUDE BURRS.

### LEAD ASSIGNMENTS

- 1 - GATE
- 2 - DRAIN
- 3 - SOURCE

### MINIMUM RECOMMENDED FOOTPRINT



International  
**IR** Rectifier

**IR WORLD HEADQUARTERS:** 233 Kansas St., El Segundo, California 90245, USA Tel: (310) 252-7105  
**IR EUROPEAN REGIONAL CENTRE:** 439/445 Godstone Rd, Whyteleafe, Surrey CR3 OBL, UK Tel: ++ 44 (0)20 8645 8000  
**IR CANADA:** 15 Lincoln Court, Brampton, Ontario L6T3Z2, Tel: (905) 453 2200  
**IR GERMANY:** Saalburgstrasse 157, 61350 Bad Homburg Tel: ++ 49 (0) 6172 96590  
**IR ITALY:** Via Liguria 49, 10071 Borgaro, Torino Tel: ++ 39 011 451 0111  
**IR JAPAN:** K&H Bldg., 2F, 30-4 Nishi-Ikebukuro 3-Chome, Toshima-Ku, Tokyo 171 Tel: 81 (0)3 3983 0086  
**IR SOUTHEAST ASIA:** 1 Kim Seng Promenade, Great World City West Tower, 13-11, Singapore 237994 Tel: ++ 65 (0)838 4630  
**IR TAIWAN:** 16 Fl. Suite D. 207, Sec. 2, Tun Haw South Road, Taipei, 10673 Tel: 886-(0)2 2377 9936  
*Data and specifications subject to change without notice. 4/00*