

APED3820SURC

HYPER RED

Features

- 3.8mmx2.0mm SMT LED,3.2mm THICKNESS.
- LOW POWER CONSUMPTION.
- IDEAL FOR BACKLIGHT AND INDICATOR.
- VARIOUS COLORS AND LENS TYPES AVAILABLE.
- PACKAGE :500PCS / REEL.

Description

The Hyper Red source color devices are made with DH InGaAlP on GaAs substrate Light Emitting Diode.

Package Dimensions

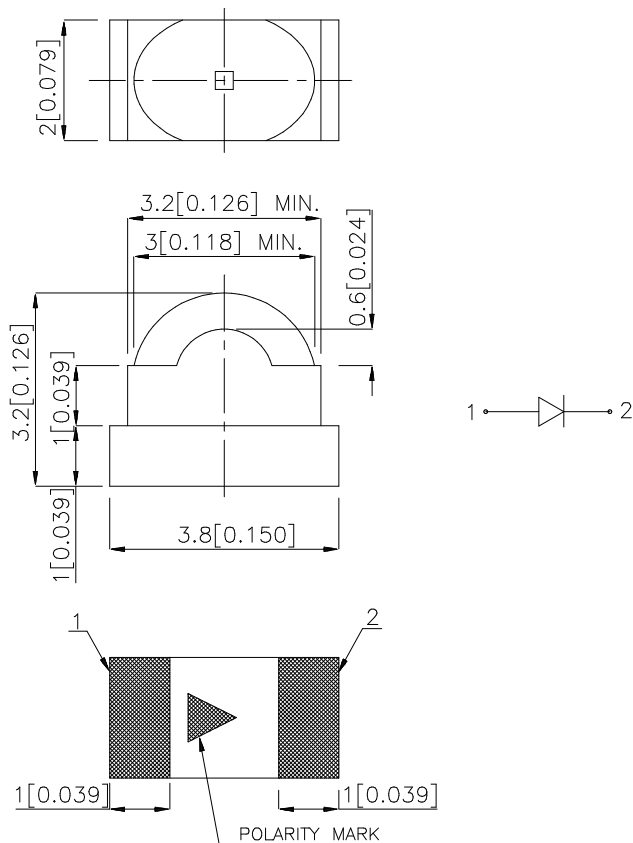

Notes:

1. All dimensions are in millimeters (inches).
2. Tolerance is ± 0.2 (0.008") unless otherwise noted.
3. Specifications are subject to change without notice.

Selection Guide

Part No.	Dice	Lens Type	Iv (mcd) @ 20 mA		Viewing Angle
			Min.	Typ.	2θ1/2
APED3820SURC	HYPER RED(InGaAlP)	WATER CLEAR	180	500	60° (H) 35° (V)

Note:

1. θ1/2 is the angle from optical centerline where the luminous intensity is 1/2 the optical centerline value.

Electrical / Optical Characteristics at T_A=25°C

Symbol	Parameter	Device	Typ.	Max.	Units	Test Conditions
λ _{peak}	Peak Wavelength	Hyper Red	640		nm	I _F =20mA
λ _D	Dominate Wavelength	Hyper Red	628		nm	I _F =20mA
Δλ _{1/2}	Spectral Line Half-width	Hyper Red	27		nm	I _F =20mA
C	Capacitance	Hyper Red	45		pF	V _F =0V;f=1MHz
V _F	Forward Voltage	Hyper Red	1.9	2.5	V	I _F =20mA
I _R	Reverse Current	Hyper Red		10	μA	V _R = 5V

Absolute Maximum Ratings at T_A=25°C

Parameter	Hyper Red	Units
Power dissipation	170	mW
DC Forward Current	30	mA
Peak Forward Current [1]	185	mA
Reverse Voltage	5	V
Operating / Storage Temperature	-40°C To +85°C	

Note:

1. 1/10 Duty Cycle, 0.1ms Pulse Width.

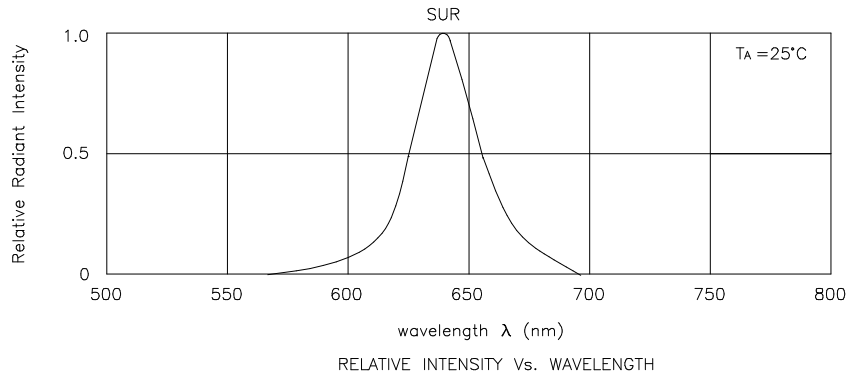

Hyper Red

APED3820SURC

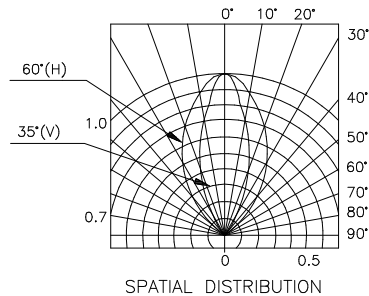
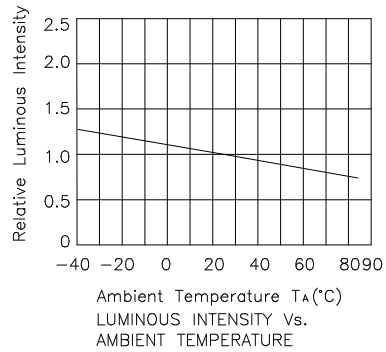
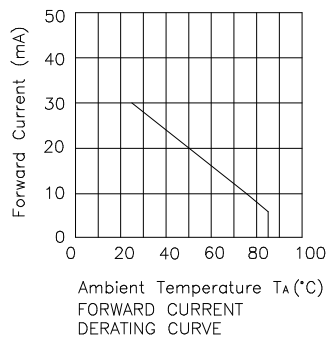
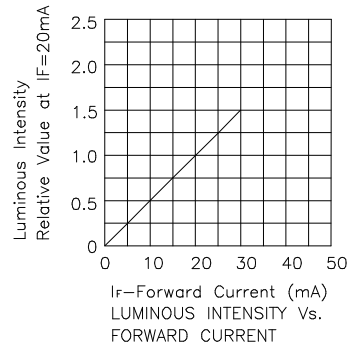
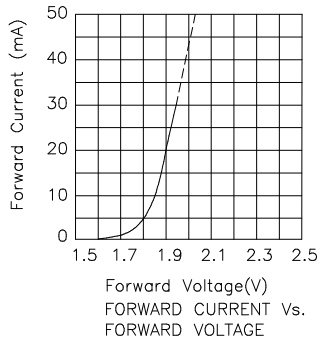

APED3820SURC SMT Reflow Soldering Instructions

Number of reflow process shall be less than 2 times and cooling process to normal temperature is required between first and second soldering process.

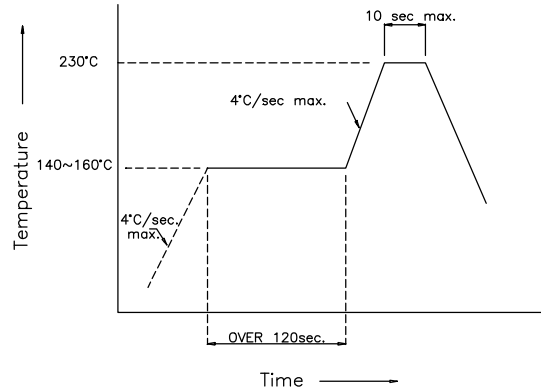

Recommended Soldering Pattern (Units : mm)

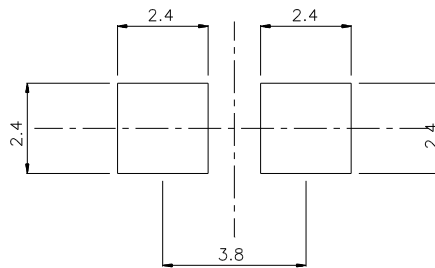

Tape Specifications (Units : mm)

