

Bias Resistor Transistor

NPN Silicon Surface Mount Transistor with Monolithic Bias Resistor Network

This new series of digital transistors is designed to replace a single device and its external resistor bias network. The BRT (Bias Resistor Transistor) contains a single transistor with a monolithic bias network consisting of two resistors; a series base resistor and a base-emitter resistor. The BRT eliminates these individual components by integrating them into a single device. The use of a BRT can reduce both system cost and board space. The device is housed in the SOT-23 package which is designed for low power surface mount applications.

- Simplifies Circuit Design
- Reduces Board Space and Component Count
- The SOT-23 package can be soldered using wave or reflow. The modified gull-winged leads absorb thermal stress during soldering eliminating the possibility of damage to the die.
- Available in 8 mm embossed tape and reel. Use the Device Number to order the 7 inch/3000 unit reel. Replace “T1” with “T3” in the Device Number to order the 13 inch/10,000 unit reel.

MAXIMUM RATINGS (T_A = 25°C unless otherwise noted)

Rating	Symbol	Value	Unit
Collector-Base Voltage	V _{CBO}	50	Vdc
Collector-Emitter Voltage	V _{CEO}	50	Vdc
Collector Current	I _C	100	mAdc
Total Power Dissipation @ T _A = 25°C (Note 1.) Derate above 25°C	P _D	200 1.6	mW mW/°C

DEVICE MARKING AND RESISTOR VALUES

Device	Marking	R1(K)	R2(K)
MMUN2211LT1	A8A	10	10
MMUN2212LT1	A8B	22	22
MMUN2213LT1	A8C	47	47
MMUN2214LT1	A8D	10	47
MMUN2215LT1	A8E	10	∞
MMUN2216LT1	A8F	4.7	∞
MMUN2230LT1	A8G	1.0	1.0
MMUN2231LT1	A8H	2.2	2.2
MMUN2232LT1	A8J	4.7	4.7
MMUN2233LT1	A8K	4.7	47
MMUN2234LT1	A8L	22	47
MMUN2235LT1	A8M	2.2	47
MMUN2238LT1	A8R	2.2	∞
MMUN2241LT1	A8U	100	∞

1. Device mounted on a FR-4 glass epoxy printed circuit board using the minimum recommended footprint.

MMUN2211LT1 SERIES

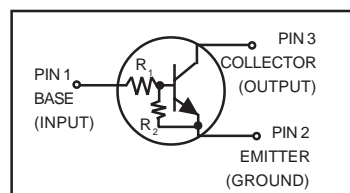
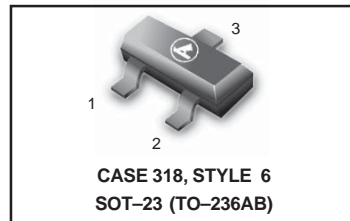

MARKING DIAGRAM

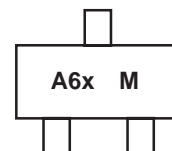

A6x = Device Marking
x = A - L (See Page 2)
M = Date Code

ORDERING INFORMATION

Device	Package	Shipping
MMUN2211LT1	SOT-23	3000/Tape & Reel
MMUN2212LT1	SOT-23	3000/Tape & Reel
MMUN2213LT1	SOT-23	3000/Tape & Reel
MMUN2214LT1	SOT-23	3000/Tape & Reel
MMUN2215LT1	SOT-23	3000/Tape & Reel
MMUN2216LT1	SOT-23	3000/Tape & Reel
MMUN2230LT1	SOT-23	3000/Tape & Reel
MMUN2231LT1	SOT-23	3000/Tape & Reel
MMUN2232LT1	SOT-23	3000/Tape & Reel
MMUN2233LT1	SOT-23	3000/Tape & Reel
MMUN2234LT1	SOT-23	3000/Tape & Reel
MMUN2235LT1	SOT-23	3000/Tape & Reel
MMUN2238LT1	SOT-23	3000/Tape & Reel
MMUN2241LT1	SOT-23	3000/Tape & Reel

MMUN2211LT1 Series

THERMAL CHARACTERISTICS

Rating	Symbol	Value	Unit
Thermal Resistance – Junction-to-Ambient (surface mounted)	$R_{\theta JA}$	625	°C/W
Operating and Storage Temperature Range	T_J, T_{stg}	-65 to +150	°C
Maximum Temperature for Soldering Purposes, Time in Solder Bath	T_L	260 10	°C Sec

ELECTRICAL CHARACTERISTICS ($T_A = 25^\circ\text{C}$ unless otherwise noted)

Characteristic	Symbol	Min	Typ	Max	Unit
----------------	--------	-----	-----	-----	------

OFF CHARACTERISTICS

Collector-Base Cutoff Current ($V_{CB} = 50\text{ V}, I_E = 0$)	I_{CBO}	–	–	100	nAdc
Collector-Emitter Cutoff Current ($V_{CE} = 50\text{ V}, I_B = 0$)	I_{CEO}	–	–	500	nAdc
Emitter-Base Cutoff Current ($V_{EB} = 6.0\text{ V}, I_C = 0$)	I_{EBO}	–	–	0.5	mAdc
MMUN2211LT1		–	–	0.2	
MMUN2212LT1		–	–	0.1	
MMUN2213LT1		–	–	0.2	
MMUN2214LT1		–	–	0.9	
MMUN2215LT1		–	–	1.9	
MMUN2216LT1		–	–	4.3	
MMUN2230LT1		–	–	2.3	
MMUN2231LT1		–	–	1.5	
MMUN2232LT1		–	–	0.18	
MMUN2233LT1		–	–	0.13	
MMUN2234LT1		–	–	0.2	
MMUN2235LT1		–	–	4.0	
MMUN2238LT1		–	–	0.1	
MMUN2241LT1		–	–		
Collector-Base Breakdown Voltage ($I_C = 10\ \mu\text{A}, I_E = 0$)	$V_{(BR)CBO}$	50	–	–	Vdc
Collector-Emitter Breakdown Voltage (Note 2.), ($I_C = 2.0\text{ mA}, I_B = 0$)	$V_{(BR)CEO}$	50	–	–	Vdc

ON CHARACTERISTICS (Note 2.)

DC Current Gain ($V_{CE} = 10\text{ V}, I_C = 5.0\text{ mA}$)	h_{FE}	35	60	–	
MMUN2211LT1		60	100	–	
MMUN2212LT1		80	140	–	
MMUN2213LT1		80	140	–	
MMUN2214LT1		160	350	–	
MMUN2215LT1		160	350	–	
MMUN2216LT1		3.0	5.0	–	
MMUN2230LT1		8.0	15	–	
MMUN2231LT1		15	30	–	
MMUN2232LT1		80	200	–	
MMUN2233LT1		80	150	–	
MMUN2234LT1		80	140	–	
MMUN2235LT1		160	350	–	
MMUN2238LT1		160	350	–	
MMUN2241LT1				–	
Collector-Emitter Saturation Voltage ($I_C = 10\text{ mA}, I_B = 0.3\text{ mA}$) ($I_C = 10\text{ mA}, I_B = 5\text{ mA}$) MMUN2230LT1/MMUN2231LT1 ($I_C = 10\text{ mA}, I_B = 1\text{ mA}$) MMUN2215LT1/MMUN2216LT1 MMUN2232LT1/MMUN2233LT1/MMUN2234LT1/ MMUN2235LT1/MMUN2238LT1	$V_{CE(sat)}$	–	–	0.25	Vdc

2. Pulse Test: Pulse Width < 300 μs , Duty Cycle < 2.0%.

MMUN2211LT1 Series

ELECTRICAL CHARACTERISTICS ($T_A = 25^\circ\text{C}$ unless otherwise noted) (Continued)

Characteristic	Symbol	Min	Typ	Max	Unit
ON CHARACTERISTICS (Note 3.)					
Output Voltage (on) ($V_{CC} = 5.0\text{ V}$, $V_B = 2.5\text{ V}$, $R_L = 1.0\text{ k}\Omega$)	V_{OL}	–	–	0.2	Vdc
MMUN2211LT1		–	–	0.2	
MMUN2212LT1		–	–	0.2	
MMUN2214LT1		–	–	0.2	
MMUN2215LT1		–	–	0.2	
MMUN2216LT1		–	–	0.2	
MMUN2230LT1		–	–	0.2	
MMUN2231LT1		–	–	0.2	
MMUN2232LT1		–	–	0.2	
MMUN2233LT1		–	–	0.2	
MMUN2234LT1		–	–	0.2	
MMUN2235LT1		–	–	0.2	
MMUN2238LT1		–	–	0.2	
($V_{CC} = 5.0\text{ V}$, $V_B = 3.5\text{ V}$, $R_L = 1.0\text{ k}\Omega$)		–	–	0.2	
($V_{CC} = 5.0\text{ V}$, $V_B = 5.0\text{ V}$, $R_L = 1.0\text{ k}\Omega$)		–	–	0.2	
MMUN2213LT1		–	–	0.2	
MMUN2241LT1		–	–	0.2	
Output Voltage (off) ($V_{CC} = 5.0\text{ V}$, $V_B = 0.5\text{ V}$, $R_L = 1.0\text{ k}\Omega$) ($V_{CC} = 5.0\text{ V}$, $V_B = 0.050\text{ V}$, $R_L = 1.0\text{ k}\Omega$) ($V_{CC} = 5.0\text{ V}$, $V_B = 0.25\text{ V}$, $R_L = 1.0\text{ k}\Omega$)	V_{OH}	4.9	–	–	Vdc
MMUN2230LT1					
MMUN2215LT1					
MMUN2216LT1					
MMUN2233LT1					
MMUN2238LT1					
Input Resistor	R_1	7.0	10	13	$\text{k}\Omega$
MMUN2211LT1		15.4	22	28.6	
MMUN2212LT1		32.9	47	61.1	
MMUN2213LT1		7.0	10	13	
MMUN2214LT1		7.0	10	13	
MMUN2215LT1		3.3	4.7	6.1	
MMUN2216LT1		0.7	1.0	1.3	
MMUN2230LT1		1.5	2.2	2.9	
MMUN2231LT1		3.3	4.7	6.1	
MMUN2232LT1		3.3	4.7	6.1	
MMUN2233LT1		15.4	22	28.6	
MMUN2234LT1		1.54	2.2	2.86	
MMUN2235LT1		1.54	2.2	2.88	
MMUN2238LT1		70	100	130	
MMUN2241LT1					
Resistor Ratio	R_1/R_2	0.8	1.0	1.2	
MMUN2211LT1/MMUN2212LT1/MMUN2213LT1		0.17	0.21	0.25	
MMUN2214LT1		–	–	–	
MMUN2215LT1/MMUN2216LT1/MMUN2238LT1		–	–	–	
MMUN2241LT1		–	–	–	
MMUN2230LT1/MMUN2231LT1/MMUN2232LT1		0.8	1.0	1.2	
MMUN2233LT1		0.055	0.1	0.185	
MMUN2234LT1		0.38	0.47	0.56	
MMUN2235LT1		0.038	0.047	0.056	

3. Pulse Test: Pulse Width < 300 μs , Duty Cycle < 2.0%.

MMUN2211LT1 Series

TYPICAL ELECTRICAL CHARACTERISTICS
MMUN2211LT1

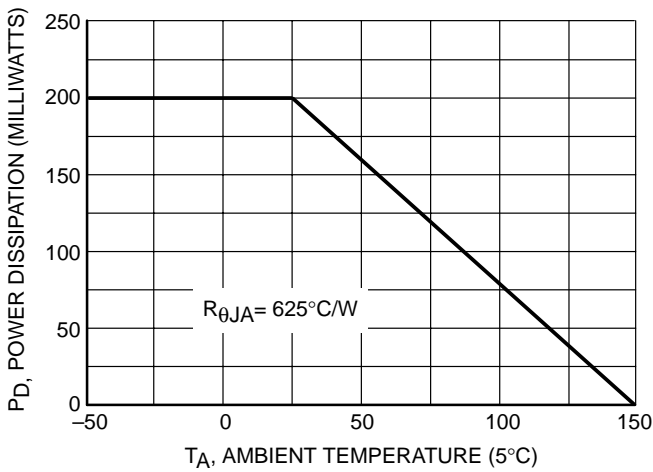

Figure 1. Derating Curve

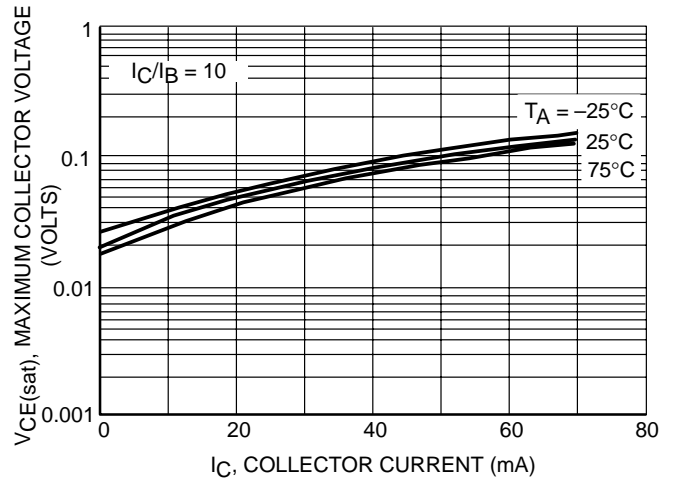

Figure 2. $V_{CE(sat)}$ vs. I_C

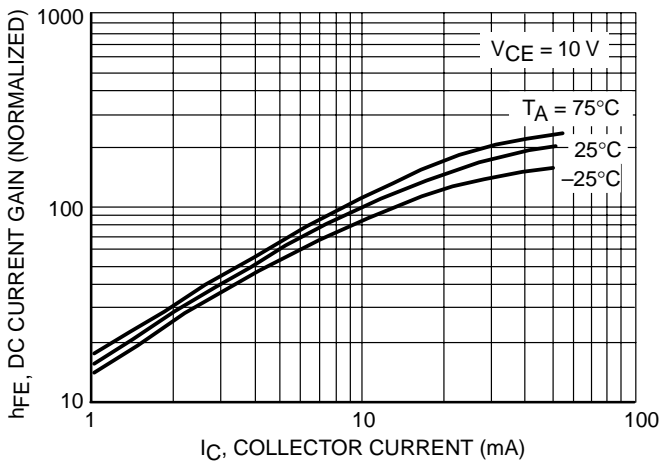

Figure 3. DC Current Gain

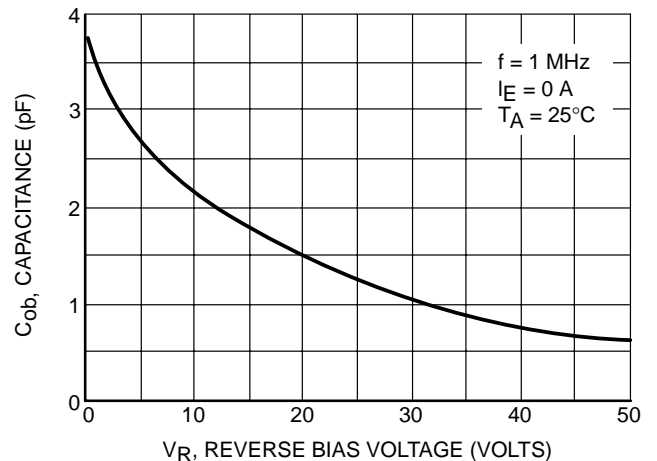

Figure 4. Output Capacitance

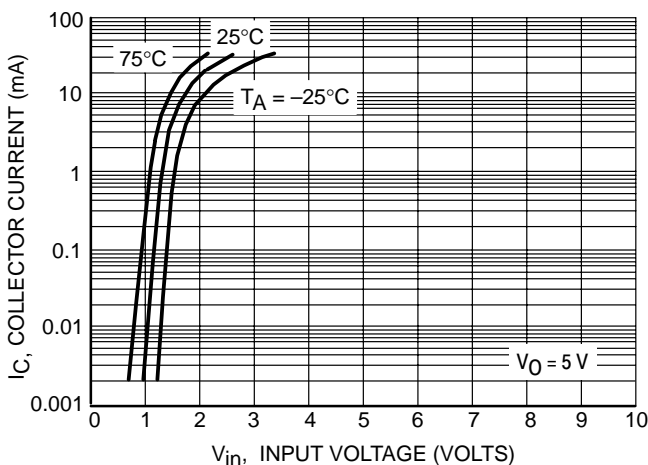

Figure 5. Output Current vs. Input Voltage

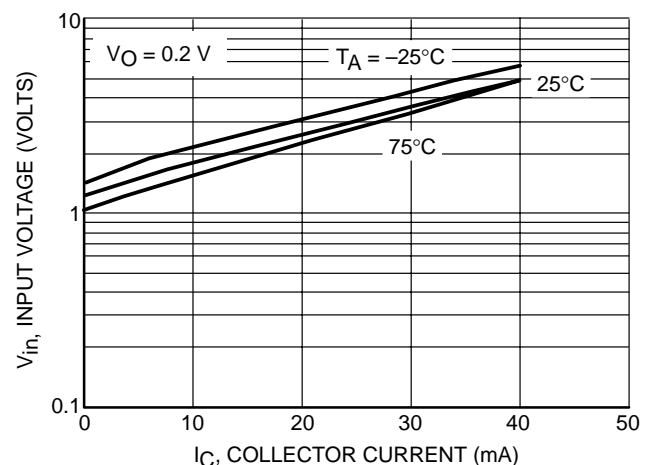

Figure 6. Input Voltage vs. Output Current

MMUN2211LT1 Series

TYPICAL ELECTRICAL CHARACTERISTICS
MMUN2212LT1

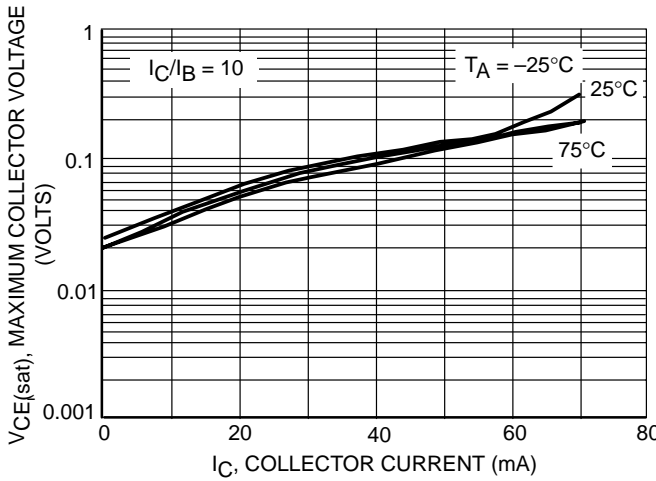

Figure 7. $V_{CE(sat)}$ vs. I_C

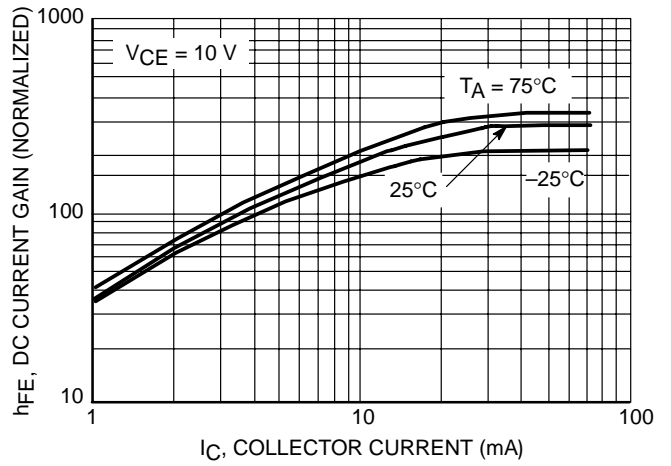

Figure 8. DC Current Gain

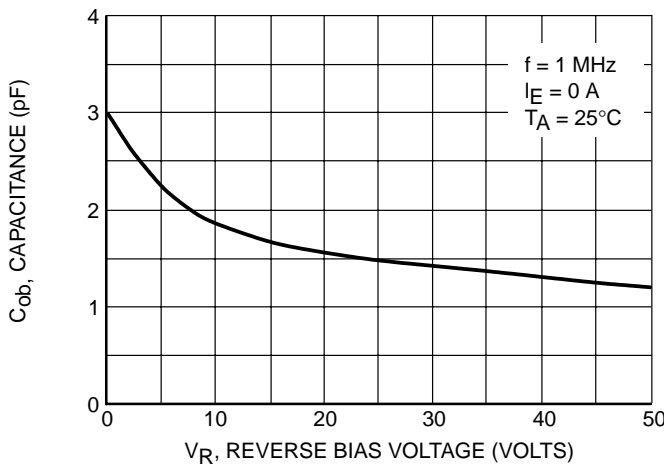

Figure 9. Output Capacitance

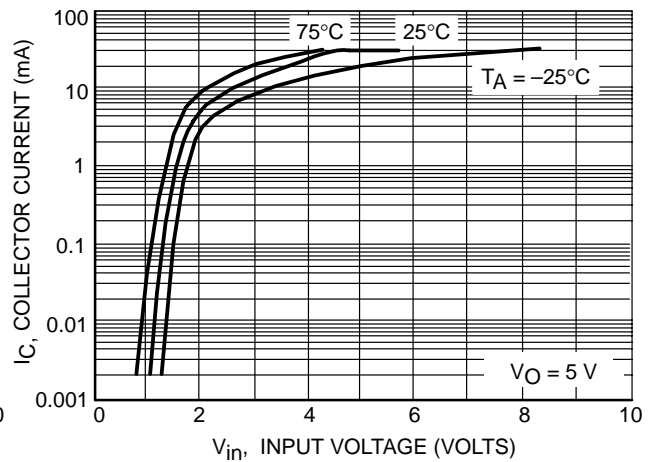

Figure 10. Output Current vs. Input Voltage

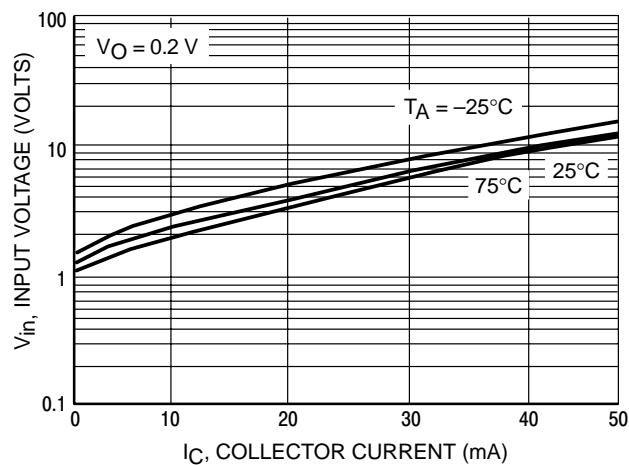

Figure 11. Input Voltage vs. Output Current

MMUN2211LT1 Series

TYPICAL ELECTRICAL CHARACTERISTICS
MMUN2213LT1

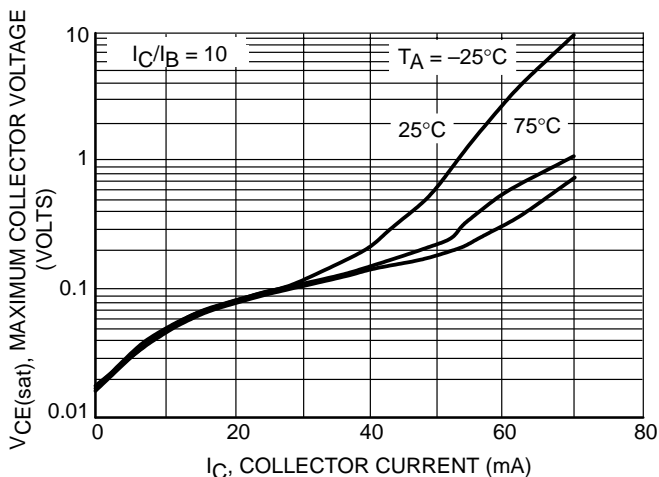

Figure 12. $V_{CE(sat)}$ vs. I_C

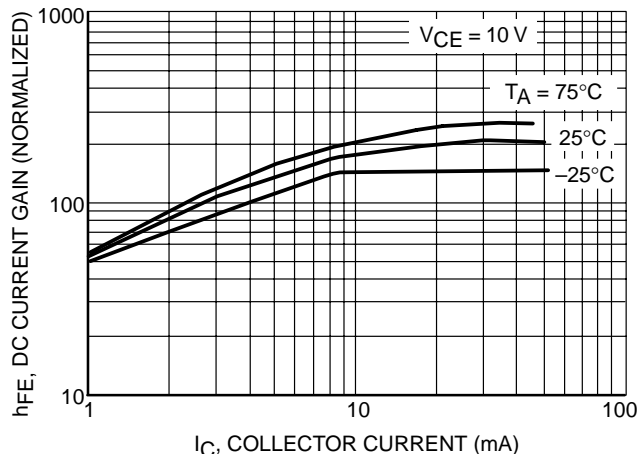

Figure 13. DC Current Gain

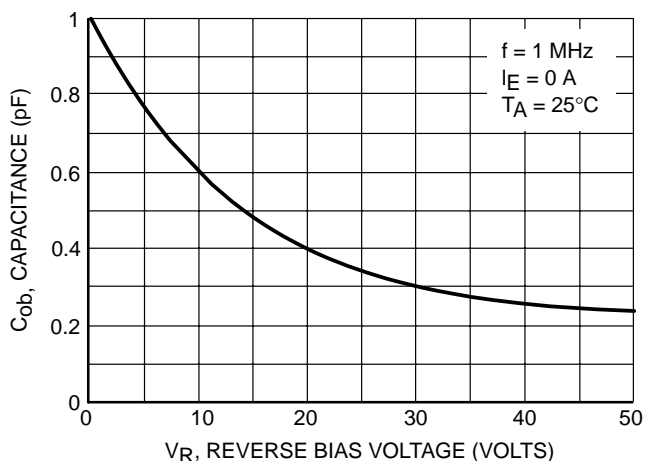

Figure 14. Output Capacitance

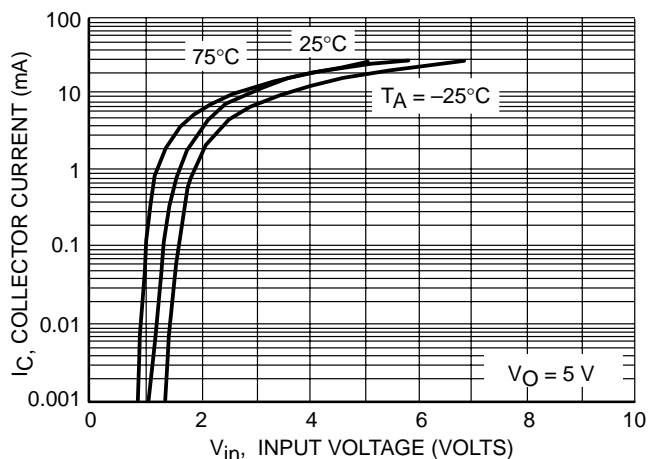

Figure 15. Output Current vs. Input Voltage

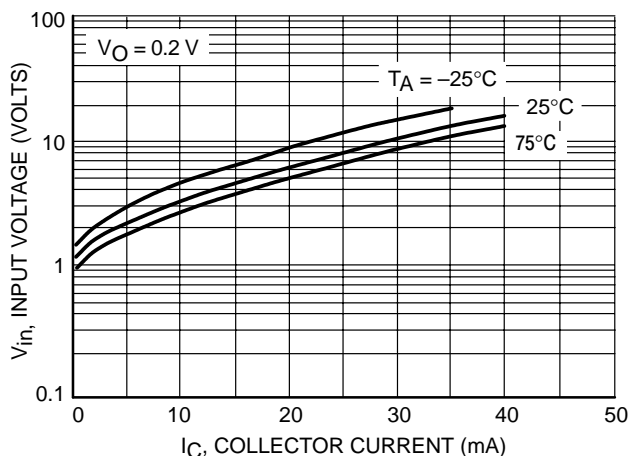

Figure 16. Input Voltage vs. Output Current

MMUN2211LT1 Series

TYPICAL ELECTRICAL CHARACTERISTICS
MMUN2214LT1

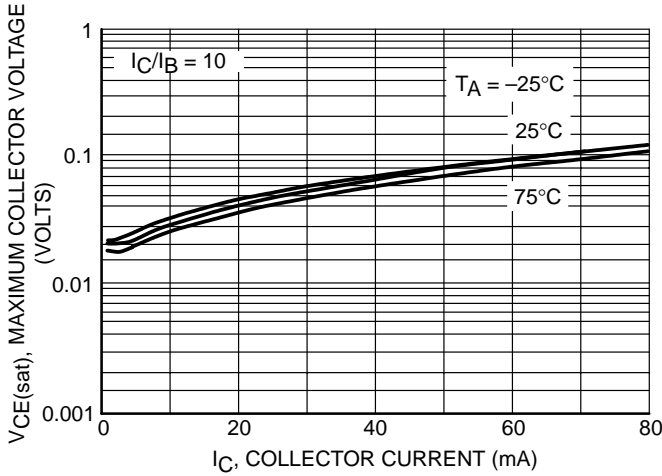

Figure 17. $V_{CE(sat)}$ vs. I_C

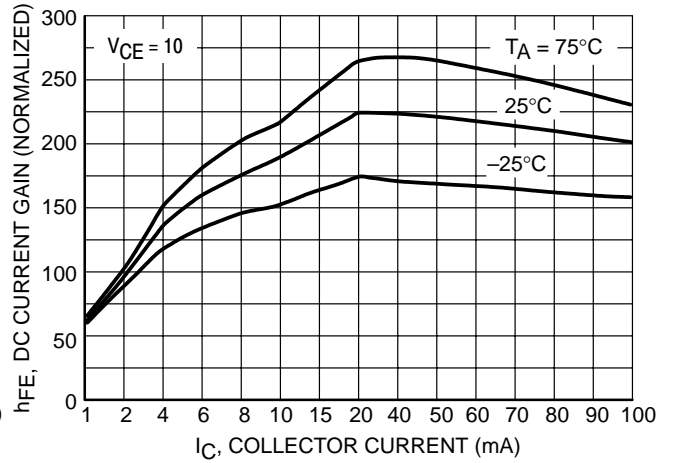

Figure 18. DC Current Gain

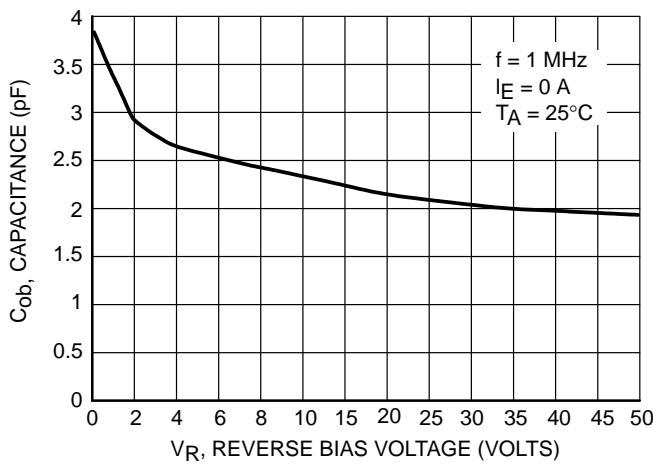

Figure 19. Output Capacitance

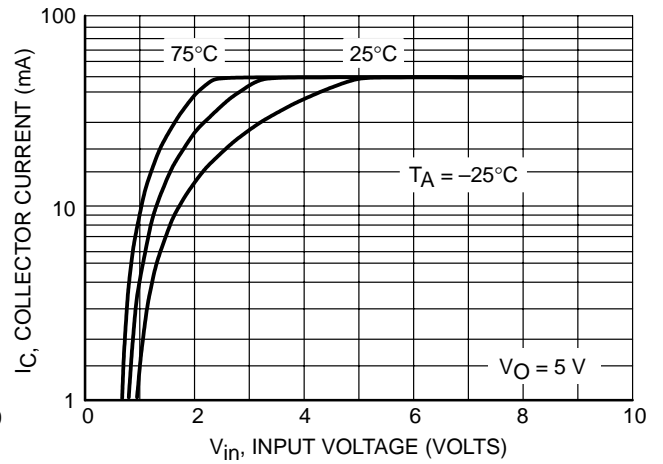

Figure 20. Output Current vs. Input Voltage

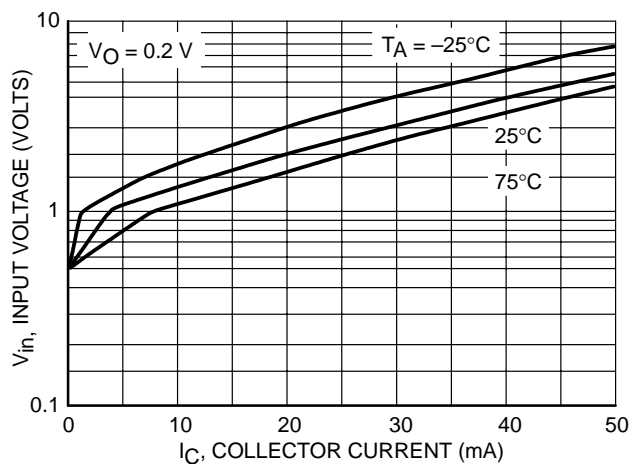

Figure 21. Input Voltage vs. Output Current

MMUN2211LT1 Series

TYPICAL ELECTRICAL CHARACTERISTICS
MMUN2232LT1

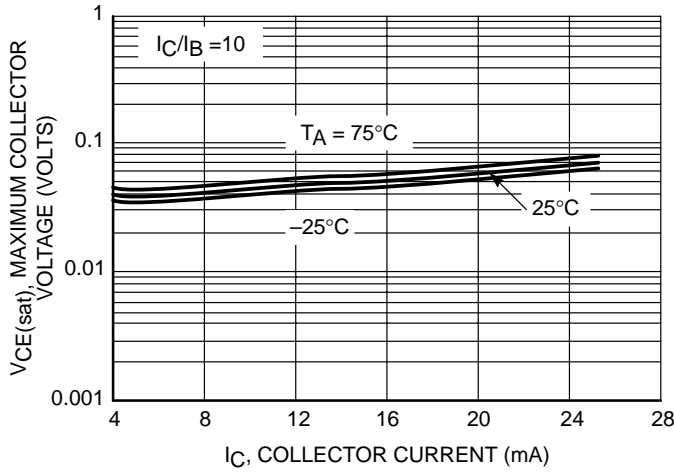

Figure 22. $V_{CE(sat)}$ vs. I_C

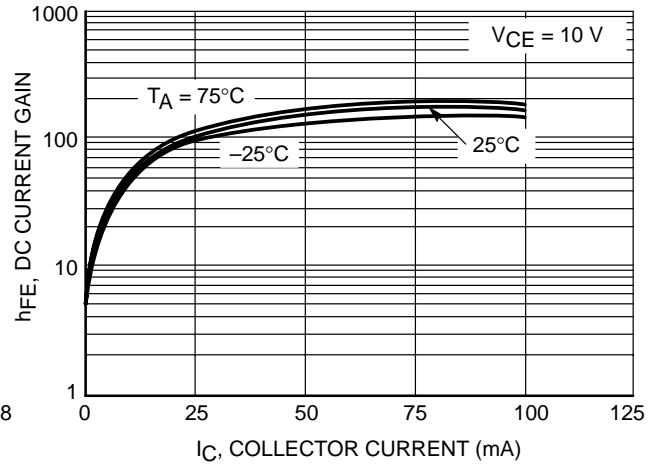

Figure 23. DC Current Gain

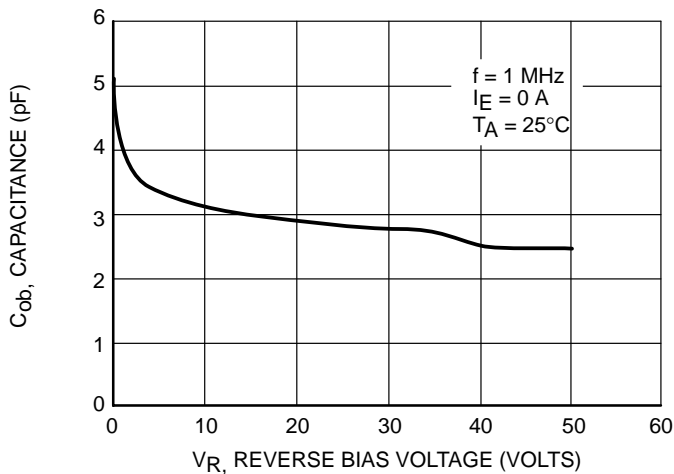

Figure 24. Output Capacitance

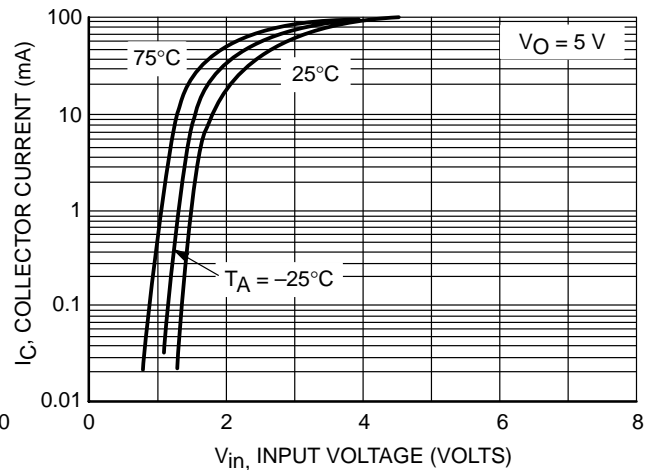

Figure 25. Output Current vs. Input Voltage

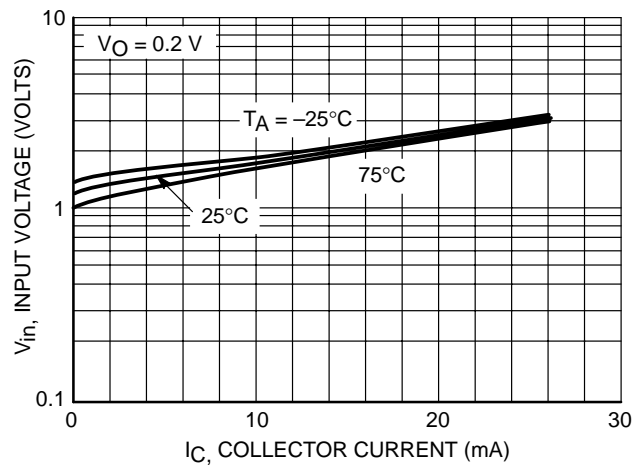

Figure 26. Output Voltage vs. Input Current

MMUN2211LT1 Series

TYPICAL ELECTRICAL CHARACTERISTICS
MMUN2233LT1

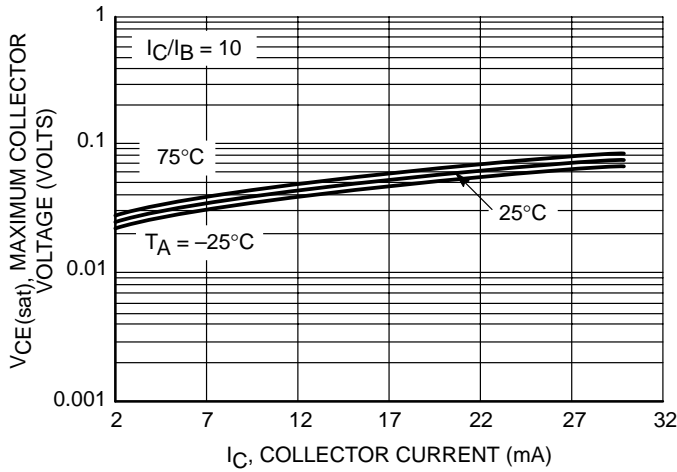

Figure 27. $V_{CE(sat)}$ vs. I_C

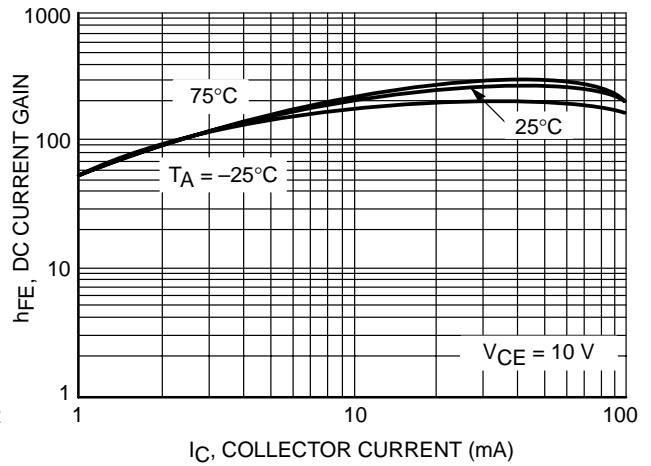

Figure 28. DC Current Gain

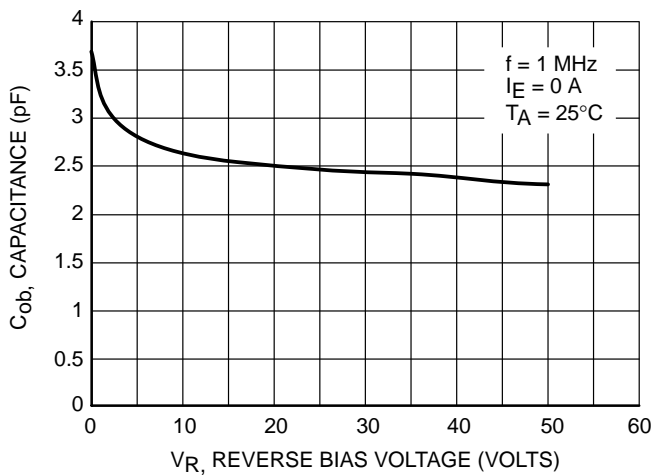

Figure 29. Output Capacitance

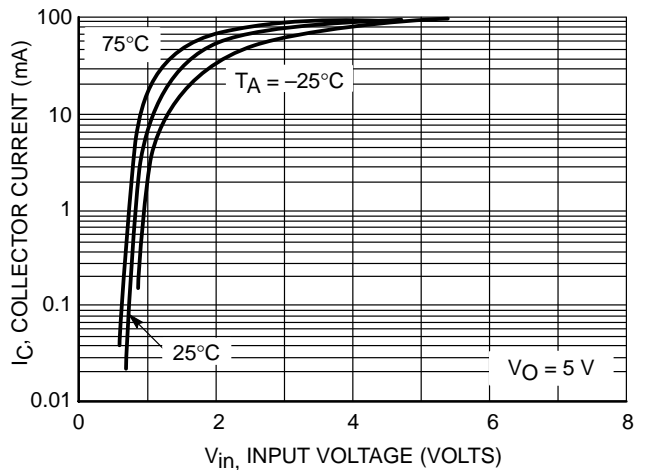

Figure 30. Output Current vs. Input Voltage

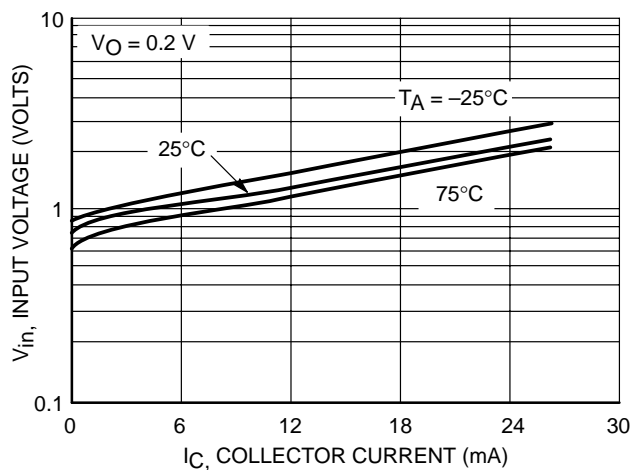

Figure 31. Input Voltage vs. Output Current

MMUN2211LT1 Series

TYPICAL APPLICATIONS FOR NPN BRTs

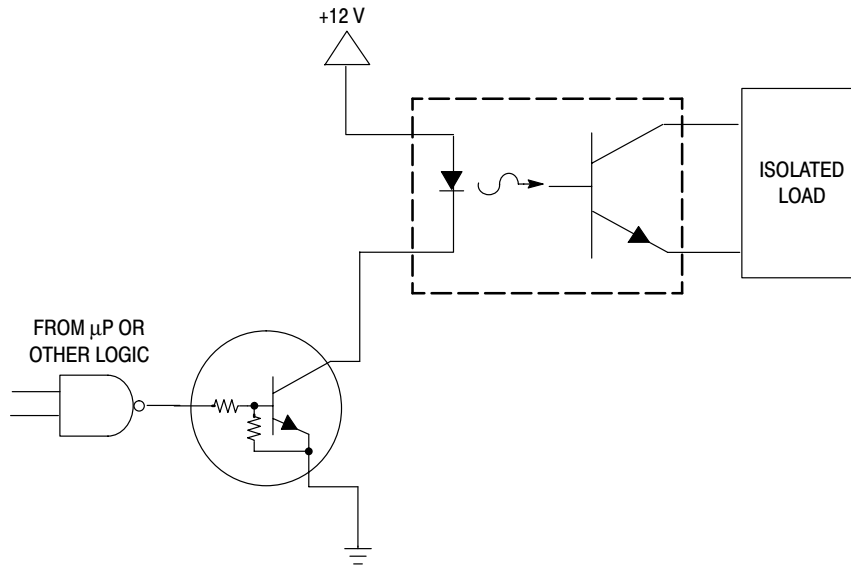

Figure 32. Level Shifter: Connects 12 or 24 Volt Circuits to Logic

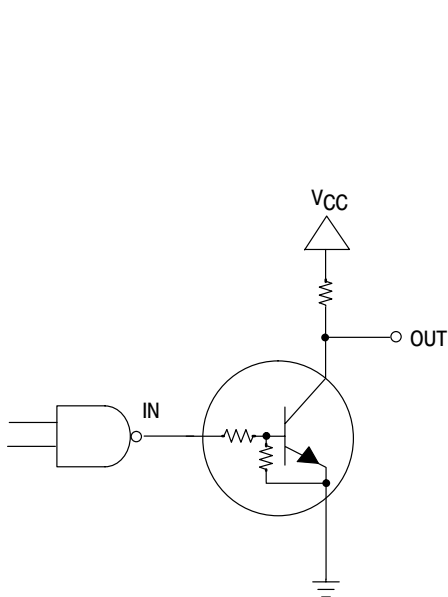

Figure 33. Open Collector Inverter: Inverts the Input Signal

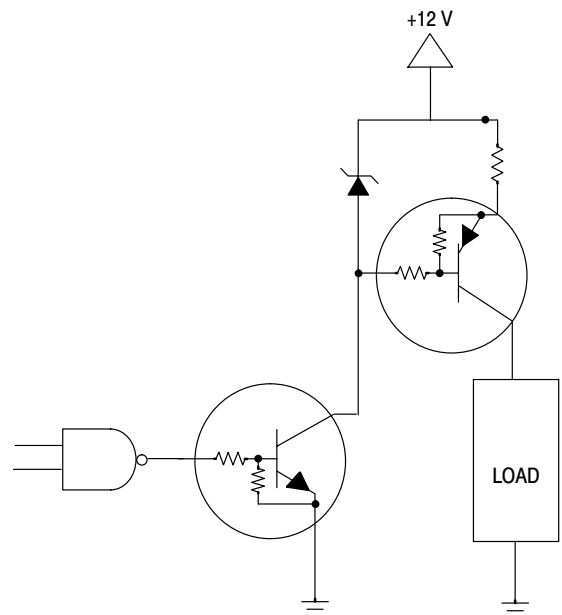

Figure 34. Inexpensive, Unregulated Current Source