



The Infinite Bandwidth Company™

# MIC4685

## 3A SPAK SuperSwitcher™ Buck Regulator

Final

### General Description

The MIC4685 is a high-efficiency 200kHz stepdown (buck) switching regulator. Power conversion efficiency of above 85% is easily obtainable for a wide variety of applications. The MIC4685 achieves 3A of continuous current in the 7-lead SPAK package.

The thermal performance of the SPAK allows it to replace TO-220s and TO-263s (D<sup>2</sup> PAKs) in many applications. The SPAK saves board space with a 36% smaller footprint than TO-263.

High efficiency is maintained over a wide output current range by utilizing a boost capacitor to increase the voltage available to saturate the internal power switch. As a result of this high efficiency, only the ground plane of the PCB is needed for a heat sink.

The MIC4685 allows for a high degree of safety. It has a wide input voltage range of 4V to 30V (34V transient), allowing it to be used in applications where input voltage transients may be present. Built-in safety features include over-current protection, frequency-foldback short-circuit protection, and thermal shutdown.

The MIC4685 is available in an 7-lead SPAK package with a junction temperature range of -40°C to +125°C.

### Features

- Low 2mm profile SPAK package
- 3A continuous output current
- Wide 4V to 30V input voltage range (34V transient)
- Fixed 200kHz PWM operation
- Over 85% efficiency
- Output voltage adjustable to 1.235V
- All surface mount solution
- Internally compensated with fast transient response
- Over-current protection
- Frequency foldback short-circuit protection
- Thermal shutdown

### Applications

- Point of load power supplies
- Simple high-efficiency step-down regulators
- 5V to 3.3V/2A conversion
- 12V to 5V/3.3V/2.5V/1.8V 3A conversion
- Dual-output ±5V conversion
- Base stations
- LCD power supplies
- Battery chargers

### Ordering Information

Part Number	Voltage	Junction Temperature Range	Package
MIC4685BR	Adj	-40°C to +125°C	SPAK-07L

### Typical Applications

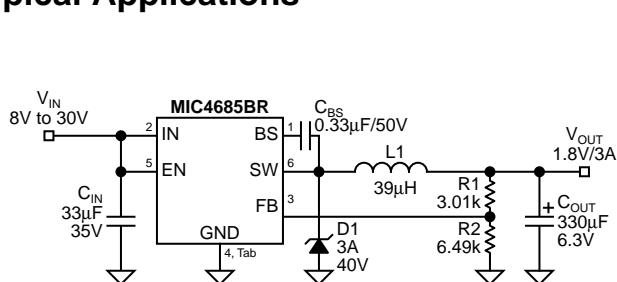

1.8V Output Converter

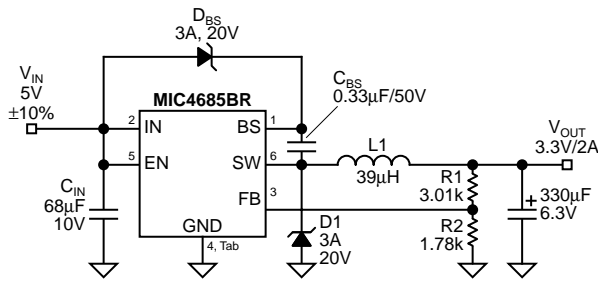

5V to 3.3V Converter

## Pin Configuration

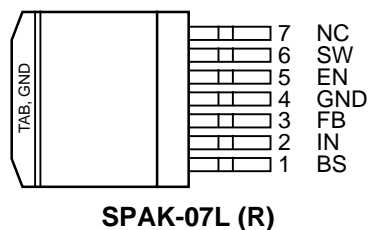

## Pin Description

Pin Number	Pin Name	Pin Function
1	BS	Bootstrap Voltage Node (External Component): Connect to external boost capacitor.
2	IN	Supply (Input): Unregulated +4V to 30V supply voltage (34V transient)
3	FB	Feedback (Input): Outback voltage feedback to regulator. Connect to 1.235V tap of resistive divider.
4, Tab	GND	Ground
5	EN	Enable (Input): Logic high = enable; logic low = shutdown
6	SW	Switch (Output): Emitter of NPN output switch. Connect to external storage inductor and Schottky diode.
7	NC	No Connect. Tie this pin to ground.

## Detailed Pin Description

### Switch (SW, Pin 6)

The switch pin is tied to the emitter of the main internal NPN transistor. This pin is biased up to the input voltage minus the  $V_{SAT}$  of the main NPN pass element. The emitter is also driven negative when the output inductor's magnetic field collapses at turn-off. During the OFF time the SW pin is clamped by the output Schottky diode to a  $-0.5V$  typically.

### Ground (GND, Pin 4, Tab)

There are two main areas of concern when it comes to the ground pin, EMI and ground current. In a buck regulator or any other non-isolated switching regulator the output capacitor(s) and diode(s) ground is referenced back to the switching regulator's or controller's ground pin. Any resistance between these reference points causes an offset voltage/IR drop proportional to load current and poor load regulation. This is why its important to keep the output grounds placed as close as possible to the switching regulator's ground pin. To keep radiated EMI to a minimum it is necessary to place the input capacitor ground lead as close as possible to the switching regulator's ground pin.

### Input Voltage ( $V_{IN}$ , Pin 2)

The  $V_{IN}$  pin is the collector of the main NPN pass element. This pin is also connected to the internal regulator. The output diode or clamping diode should have its cathode as close as possible to this point to avoid voltage spikes adding to the voltage across the collector.

### Bootstrap (BS, Pin 1)

The bootstrap pin in conjunction with the external bootstrap capacitor provides a bias voltage higher than the input voltage to the MIC4685's main NPN pass element. The bootstrap capacitor sees the  $dv/dt$  of the switching action at the SW pin as an AC voltage. The bootstrap capacitor then couples the AC voltage back to the BS pin plus the dc offset of  $V_{IN}$  where it is rectified and used to provide additional drive to the main switch, in this case a NPN transistor.

This additional drive reduces the NPN's saturation voltage and increases efficiency, from a  $V_{SAT}$  of 1.8V, and 75% efficiency to a  $V_{SAT}$  of 0.5V and 88% efficiency respectively.

### Feedback (FB, Pin 3)

The feedback pin is tied to the inverting side of an error amplifier. The noninverting side is tied to a 1.235V bandgap reference. An external resistor voltage divider is required from the output to ground, with the center tied to the feedback pin.

### Enable (EN, Pin 5)

The enable (EN) input is used to turn on the regulator and is TTL compatible. Note: connect the enable pin to the input if unused. A logic-high enables the regulator. A logic-low shuts down the regulator and reduces the stand-by quiescent input current to typically  $150\mu A$ . The enable pin has an upper threshold of 2.0V minimum and lower threshold of 0.8V maximum. The hysteresis provided by the upper and lower thresholds acts as an UVLO and prevents unwanted turn on of the regulator due to noise.

**Absolute Maximum Ratings (Note 1)**

Supply Voltage ( $V_{IN}$ ), <b>Note 1</b> .....	+34V
Enable Voltage ( $V_{EN}$ ) .....	-0.3V to $+V_{IN}$
Steady-State Output Switch Voltage ( $V_{SW}$ ) .....	-1V to $V_{IN}$
Feedback Voltage ( $V_{FB}$ ) .....	+12V
Storage Temperature ( $T_S$ ) .....	-65°C to +150°C
ESD Rating <b>Note 3</b> .....	2kV

**Operating Ratings (Note 2)**

Supply Voltage ( $V_{IN}$ ) <b>Note 4</b> .....	+4V to +30V
Junction Temperature ( $T_J$ ) .....	-40°C to +125°C
Package Thermal Resistance	
$\theta_{JA}$ , SPAK-7 Lead .....	11.8°C/W
$\theta_{JC}$ , SPAK-7 Lead .....	2.2°C/W

**Electrical Characteristics**

$V_{IN} = V_{EN} = 12V$ ,  $V_{OUT} = 5V$ ;  $I_{OUT} = 500mA$ ;  $T_A = 25^\circ C$ , unless otherwise noted. **Bold** values indicate  $-40^\circ C \leq T_J \leq +125^\circ C$ .

Parameter	Condition	Min	Typ	Max	Units
Feedback Voltage	( $\pm 2\%$ )	1.210	1.235	1.260	V
	( $\pm 3\%$ )	<b>1.198</b>		<b>1.272</b>	V
	$8V \leq V_{IN} \leq 30V$ , $0.1A \leq I_{LOAD} \leq 1A$ , $V_{OUT} = 5V$ , <b>Note 4</b>	1.186	1.235	1.284	V
		<b>1.173</b>		<b>1.297</b>	V
Feedback Bias Current			50		nA
Maximum Duty Cycle	$V_{FB} = 1.0V$		94		%
Output Leakage Current	$V_{IN} = 30V$ , $V_{EN} = 0V$ , $V_{SW} = 0V$		5	500	$\mu A$
	$V_{IN} = 30V$ , $V_{EN} = 0V$ , $V_{SW} = -1V$		1.4	20	mA
Quiescent Current	$V_{FB} = 1.5V$		6	<b>12</b>	mA
Bootstrap Drive Current	$V_{FB} = 1.5V$ , $V_{SW} = 0V$	250	380		mA
Bootstrap Voltage	$I_{BS} = 10mA$ , $V_{FB} = 1.5V$ , $V_{SW} = 0V$	5.5	6.2		V
Frequency Fold Back	$V_{FB} = 0V$	30	70	120	kHz
Oscillator Frequency		180	200	225	kHz
Saturation Voltage	$I_{OUT} = 1A$		0.59		V
Short Circuit Current Limit	$V_{FB} = 0V$ , See <i>Test Circuit</i>	3.5		6	A
Shutdown Current	$V_{EN} = 0V$		150	200	$\mu A$
Enable Input Logic Level	regulator on	2			V
	regulator off			0.8	V
Enable Pin Input Current	$V_{EN} = 0V$ (regulator off)		16	50	$\mu A$
	$V_{EN} = 12V$ (regulator on)	-1	-0.83		mA
Thermal Shutdown @ $T_J$			160		$^\circ C$

**Note 1.** Exceeding the absolute maximum rating may damage the device.

**Note 2.** The device is not guaranteed to function outside its operating rating.

**Note 3.** Devices are ESD sensitive. Handling precautions recommended. Human body model, 1.5k $\Omega$  in series with 100pF.

**Note 4.** 2.5V of headroom is required between  $V_{IN}$  and  $V_{OUT}$ . The headroom can be reduced by implementing a bootstrap diode as seen on the 5V to 3.3V circuit on page 1.

## Test Circuit

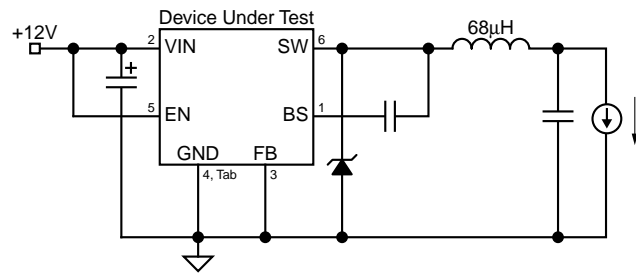

**Current Limit Test Circuit**

## Shutdown Input Behavior

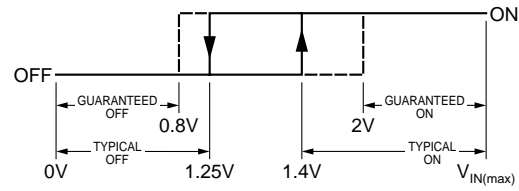

**Enable Hysteresis**

# Typical Characteristics

( $T_A = 25^\circ\text{C}$  unless otherwise noted)

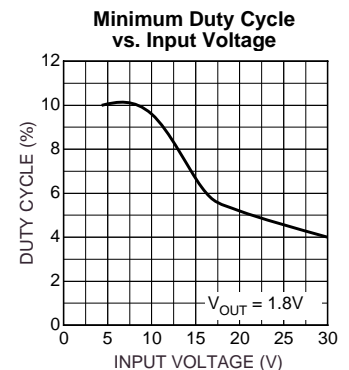
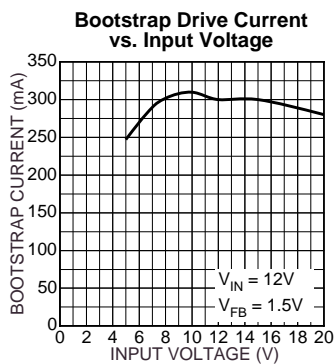
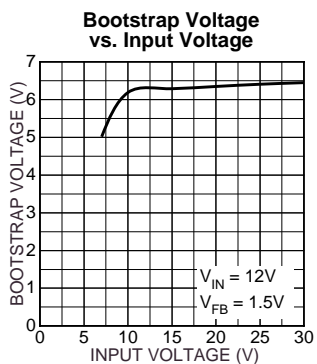
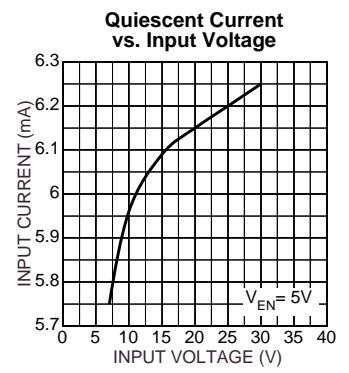
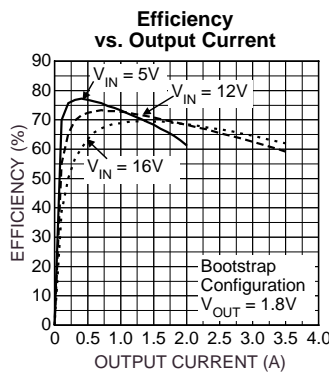
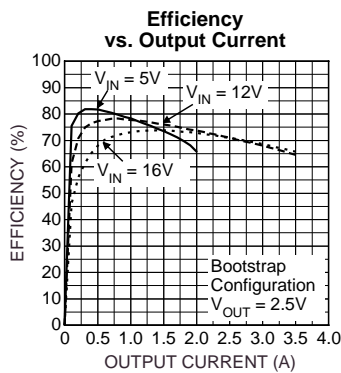
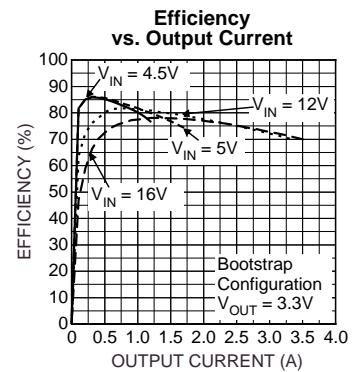
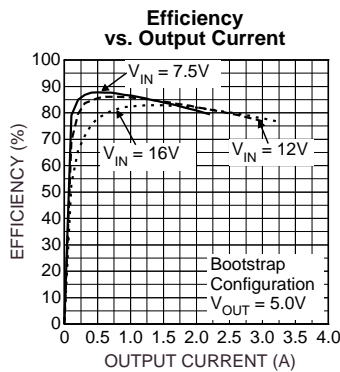
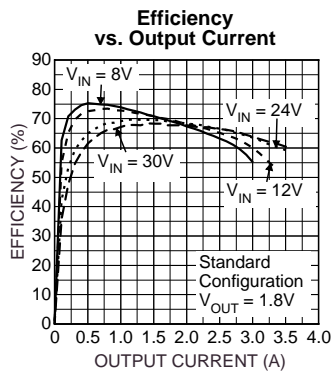
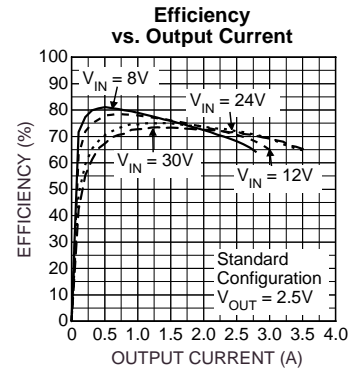
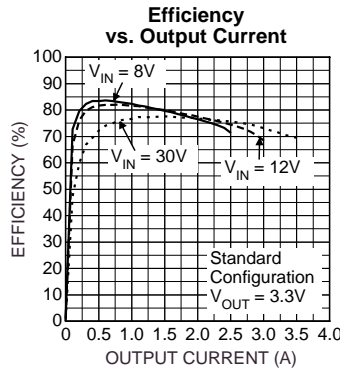
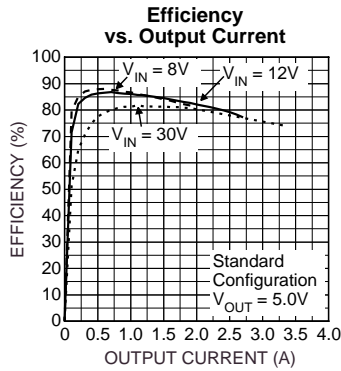

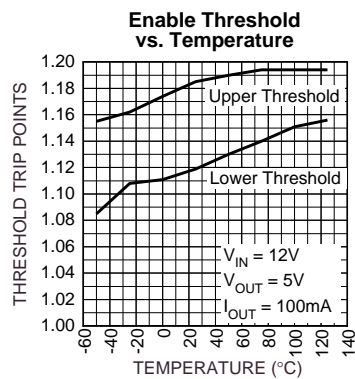
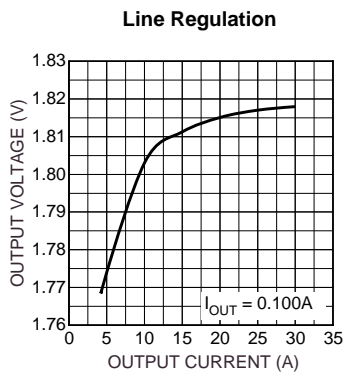
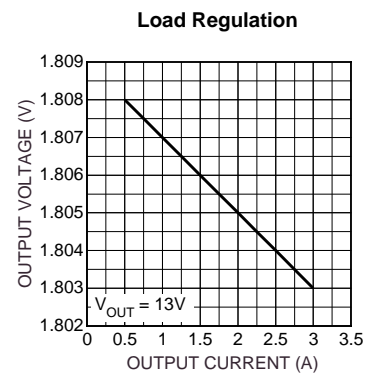
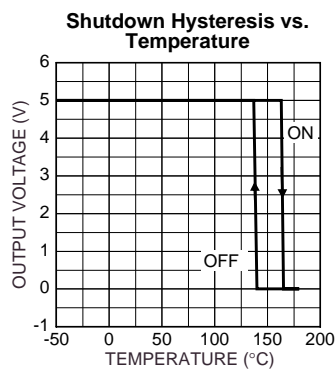
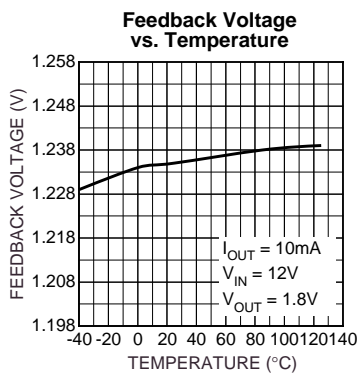
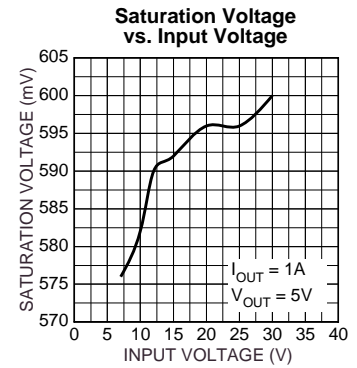
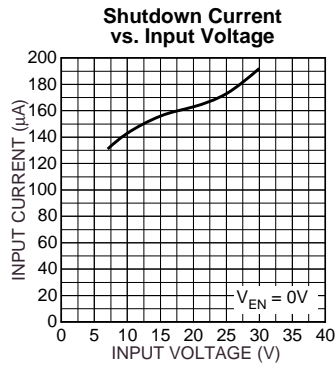
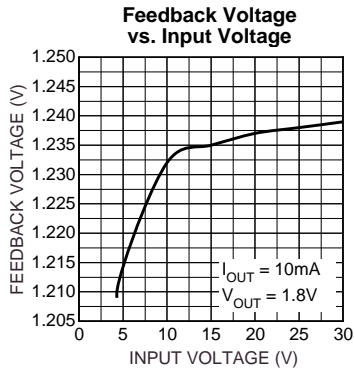

# Typical Safe Operating Area (SOA)

(SOA measured on the MIC4685 Evaluation Board\*)

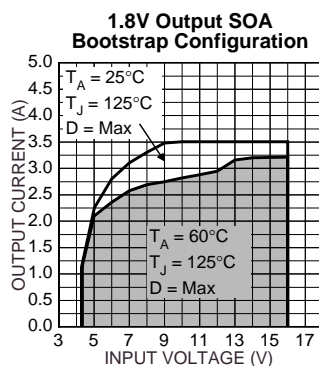
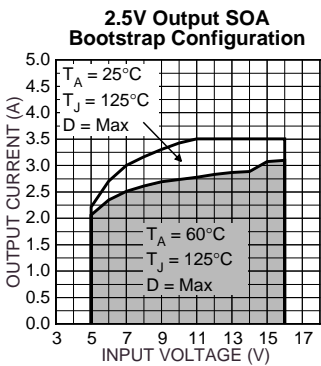
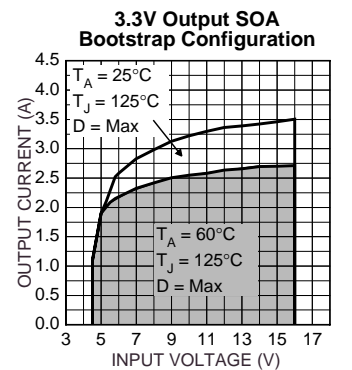
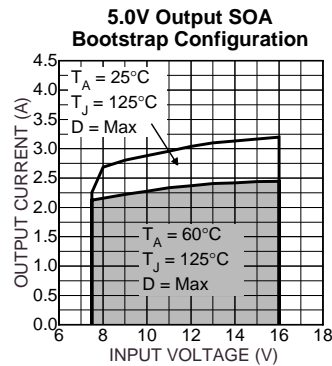
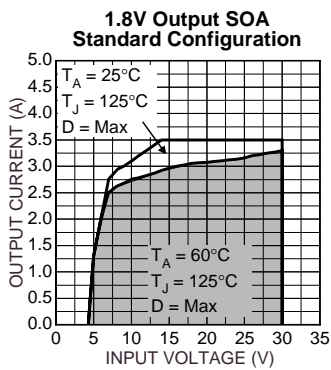
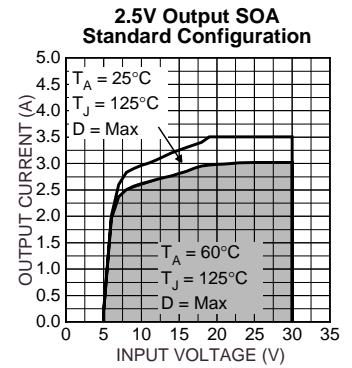
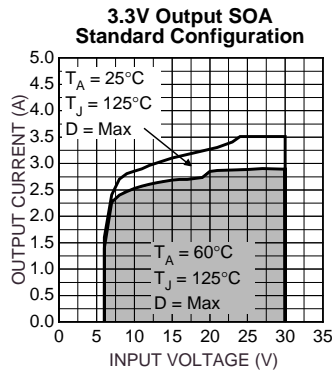
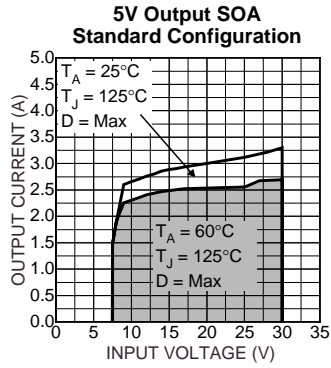

\*  $I_{OUT} < 3A$ , D1: Diode Inc. B340 (3A/40V)  
 $I_{OUT} > 3A$ , D1: SBM1040 (10A/40V)

## Functional Characteristics

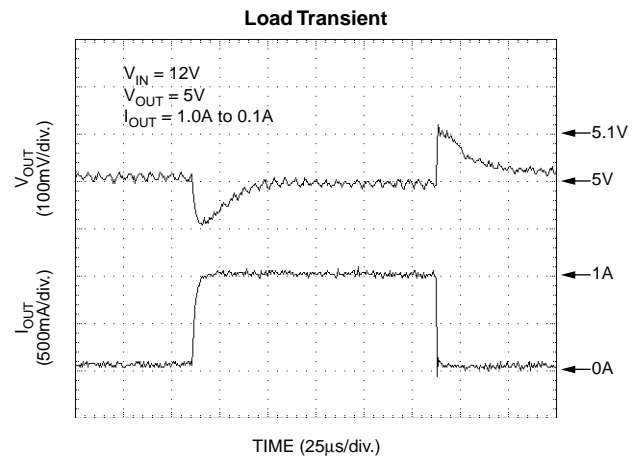
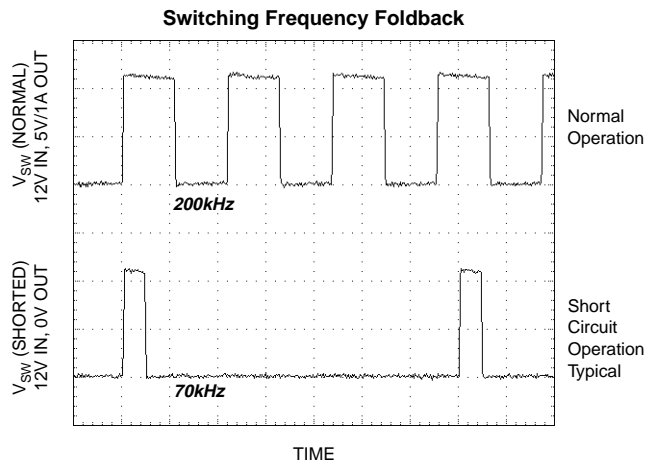

### Frequency Foldback

The MIC4685 folds the switching frequency back during a hard short circuit condition to reduce the energy per cycle and protect the device.



## Block Diagrams

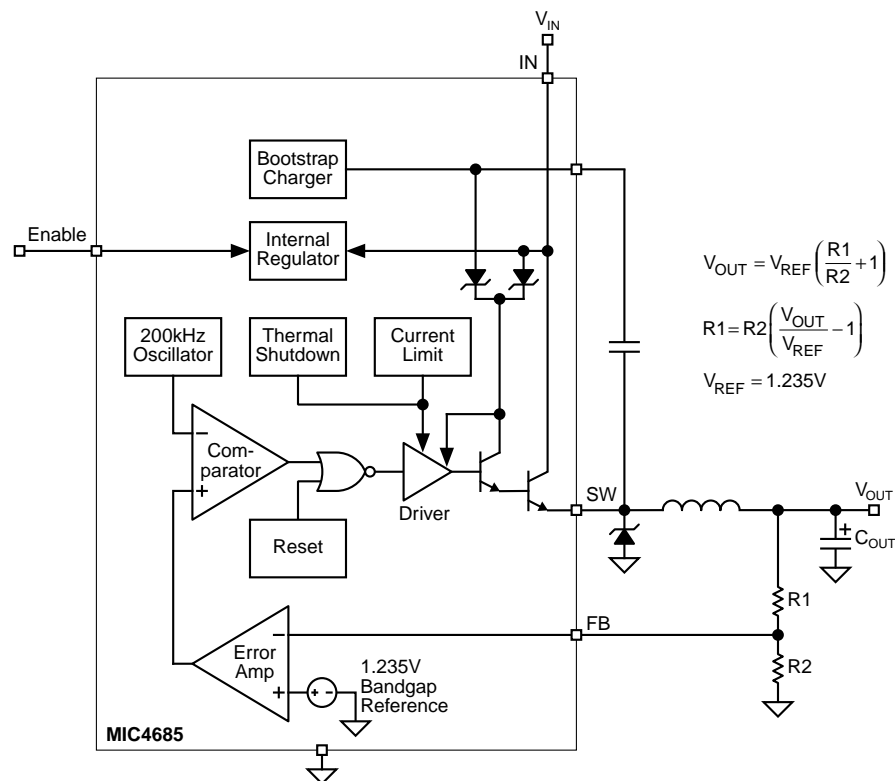

Figure 1. Adjustable Regulator

## Functional Description

The MIC4685 is a variable duty cycle switch-mode regulator with an internal power switch. Refer to the above block diagram.

### Supply Voltage

The MIC4685 operates from a +4V to +30V (34V transient) unregulated input. Highest efficiency operation is from a supply voltage around +12V. See the efficiency curves in the *Typical Characteristics* section on page 5.

### Enable/Shutdown

The enable (EN) input is TTL compatible. Tie the input high if unused. A logic-high enables the regulator. A logic-low shuts down the internal regulator which reduces the current to typically 150 $\mu$ A when  $V_{EN} = 0V$ .

### Feedback

An external resistive voltage divider is required from the output voltage to ground, center tapped to the FB pin. See Table 1 and Table 2 for recommended resistor values.

### Duty Cycle Control

A fixed-gain error amplifier compares the feedback signal with a 1.235V bandgap voltage reference. The resulting error amplifier output voltage is compared to a 200kHz sawtooth waveform to produce a voltage controlled variable duty cycle output.

A higher feedback voltage increases the error amplifier output voltage. A higher error amplifier voltage (comparator inverting input) causes the comparator to detect only the peaks of the sawtooth, reducing the duty cycle of the comparator output. A lower feedback voltage increases the duty cycle. The MIC4685 uses a voltage-mode control architecture.

### Output Switching

When the internal switch is ON, an increasing current flows from the supply  $V_{IN}$  through external storage inductor  $L1$ , to output capacitor  $C_{OUT}$  and the load. Energy is stored in the inductor as the current increases with time.

When the internal switch is turned OFF, the collapse of the magnetic field in  $L1$  forces current to flow through fast recovery diode  $D1$ , charging  $C_{OUT}$ .

### Output Capacitor

External output capacitor  $C_{OUT}$  provides stabilization and reduces ripple.

### Return Paths

During the ON portion of the cycle, the output capacitor and load currents return to the supply ground. During the OFF portion of the cycle, current is being supplied to the output capacitor and load by storage inductor  $L1$ , which means that  $D1$  is part of the high-current return path.

## Applications Information

### Adjustable Regulators

Adjustable regulators require a 1.235V feedback signal. Recommended voltage-divider resistor values for common output voltages are included in Table 1.

For other voltages, the resistor values can be determined using the following formulas:

$$V_{OUT} = V_{REF} \left( \frac{R1}{R2} + 1 \right)$$

$$R1 = R2 \left( \frac{V_{OUT}}{V_{REF}} - 1 \right)$$

$$V_{REF} = 1.235V$$

### Thermal Considerations

The MIC4685 is capable of high current due to the thermally optimized SPAK package.

One limitation of the maximum output current on any MIC4685 design is the junction-to-ambient thermal resistance ( $\theta_{JA}$ ) of the design (package and ground plane).

Examining  $\theta_{JA}$  in more detail:

$$\theta_{JA} = (\theta_{JC} + \theta_{CA})$$

where:

$\theta_{JC}$  = junction-to-case thermal resistance

$\theta_{CA}$  = case-to-ambient thermal resistance

$\theta_{JC}$  is a relatively constant 2.2°C/W for a 7-lead SPAK.

$\theta_{CA}$  is dependent on layout and is primarily governed by the connection of pins 4, and Tab to the ground plane. The purpose of the ground plane is to function as a heat sink.

#### Checking the Maximum Junction Temperature:

For this example, with an output power ( $P_{OUT}$ ) of 7.5W, (5V output at 1.5A with  $V_{IN} = 12V$ ) and 60°C maximum ambient temperature, what is the junction temperature?

Referring to the "Typical Characteristics: 5V Output Efficiency" graph, read the efficiency ( $\eta$ ) for 1.5A output current at  $V_{IN} = 12V$  or perform your own measurement.

$$\eta = 84\%$$

The efficiency is used to determine how much of the output power ( $P_{OUT}$ ) is dissipated in the regulator circuit ( $P_D$ ).

$$P_D = \frac{P_{OUT}}{\eta} - P_{OUT}$$

$$P_D = \frac{7.5W}{0.84} - 7.5W$$

$$P_D = 1.43W$$

A worst-case rule of thumb is to assume that 80% of the total output power dissipation is in the MIC4685 ( $P_{D(IC)}$ ) and 20% is in the diode-inductor-capacitor circuit.

$$P_{D(IC)} = 0.8 P_D$$

$$P_{D(IC)} = 0.8 \times 1.43W$$

$$P_{D(IC)} = 1.14W$$

Calculate the worst-case junction temperature:

$$T_J = P_{D(IC)} \theta_{JC} + (T_C - T_A) + T_{A(max)}$$

where:

$T_J$  = MIC4685 junction temperature

$P_{D(IC)}$  = MIC4685 power dissipation

$\theta_{JC}$  = junction-to-case thermal resistance.

The  $\theta_{JC}$  for the MIC4685's 7-lead SPAK is approximately 2.2°C/W.

$T_C$  = "pin" temperature measurement taken at the Tab.

$T_A$  = ambient temperature

$T_{A(max)}$  = maximum ambient operating temperature for the specific design.

Calculating the maximum junction temperature given a maximum ambient temperature of 60°C:

$$T_J = 1.14 \times 2.2^\circ C + (46^\circ C - 25^\circ C) + 60^\circ C$$

$$T_J = 83.5^\circ C$$

This value is within the allowable maximum operating junction temperature of 125°C as listed in "Operating Ratings." Typical thermal shutdown is 160°C and is listed in *Electrical Characteristics*. Also see *Typical Safe Operating Area (SOA)* graphs on page 7.

## Layout Considerations

Layout is very important when designing any switching regulator. Rapidly changing currents through the printed circuit board traces and stray inductance can generate voltage transients which can cause problems.

To minimize stray inductance and ground loops, keep trace lengths as short as possible. For example, keep D1 close to pin 6 and pin 4, and Tab, keep L1 away from sensitive node FB, and keep  $C_{IN}$  close to pin 2 and pin 4, and Tab. See *Applications Information: Thermal Considerations* for ground plane layout.

The feedback pin should be kept as far away from the switching elements (usually L1 and D1) as possible.

A circuit with sample layouts are provided. See Figure 7. Gerber files are available upon request.

## Bootstrap Diode

The bootstrap diode provides an external bias source directly to the main pass element, this reduces  $V_{SAT}$  thus allowing the MIC4685 to be used in very low head-room applications i.e.  $5V_{IN}$  to  $3.3V_{OUT}$  with high efficiencies. Bootstrap diode not for use if  $V_{IN}$  exceeds 16V,  $V_{IN}$ . See Figure 3.

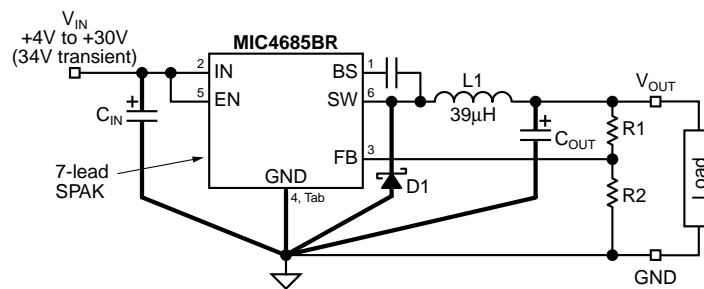

Figure 2. Critical Traces for Layout

## Recommended Components for a Given Output Voltage (Bootstrap Configuration)

$V_{OUT}$	$I_{OUT}^*$	R1	R2	$V_{IN}$	C1	D1	D2	L1	C4
5.0V	2.1A	3.01k	976 $\Omega$	7.5V–16V	47 $\mu$ F, 20V Vishay-Dale 595D476X0020D2T	3A, 30V Schottky B330A	1A, 20V Schottky MBRX120	39 $\mu$ H Sumida CDRH127R-390MC	330 $\mu$ F, 6.3V Vishay-Dale 594D337X06R3D2T
3.3V	2.2A	3.01k	1.78k	6.0V–16V	47 $\mu$ F, 20V Vishay-Dale 595D476X0020D2T	3A, 30V Schottky B330A	1A, 20V Schottky MBRX120	39 $\mu$ H Sumida CDRH127R-390MC	330 $\mu$ F, 6.3V Vishay-Dale 594D337X06R3D2T
2.5V	2.0A	3.01k	2.94k	5.0V–16V	47 $\mu$ F, 20V Vishay-Dale 595D476X0020D2T	3A, 30V Schottky B330A	1A, 20V Schottky MBRX120	39 $\mu$ H Sumida CDRH127R-390MC	330 $\mu$ F, 6.3V Vishay-Dale 594D337X06R3D2T
1.8V	2.0A	3.01k	6.49k	5.0V–16V	47 $\mu$ F, 20V Vishay-Dale 595D476X0020D2T	3A, 30V Schottky B330A	1A, 20V Schottky MBRX120	39 $\mu$ H Sumida CDRH127R-390MC	330 $\mu$ F, 6.3V Vishay-Dale 594D337X06R3D2T

\* Maximum output current at minimum input voltage. See SOA curves for maximum output current vs. input voltage.

**Table 1. Recommended Components for Common Output Voltages**

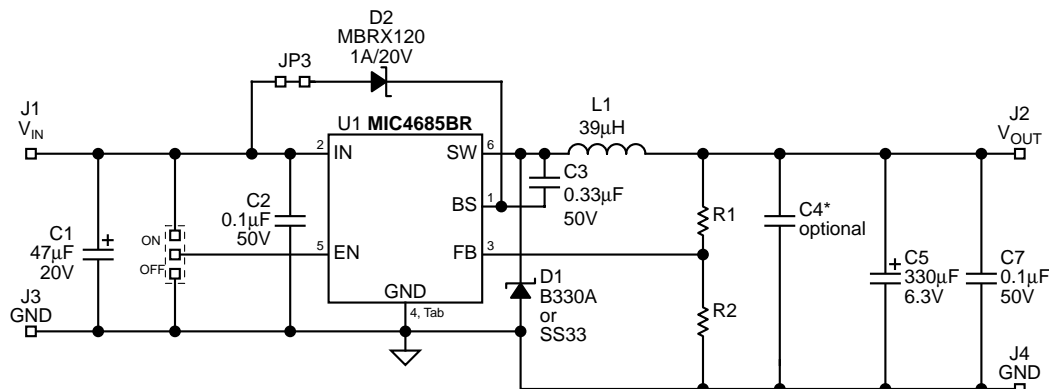

\* C4 can be used to provide additional stability and improved transient response.  
Note: optimized for 5V<sub>OUT</sub>

**Figure 3. Schematic Diagram**



## Printed Circuit Board

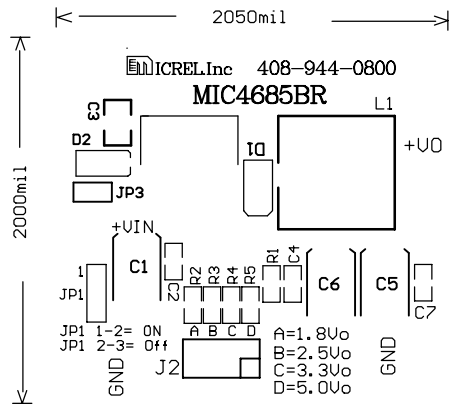

Figure 5a. Top Silk Screen

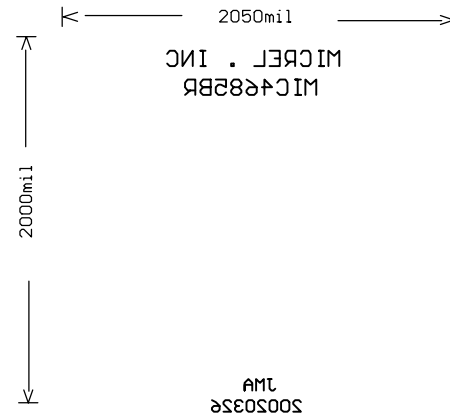

Figure 5b. Bottom Silk Screen

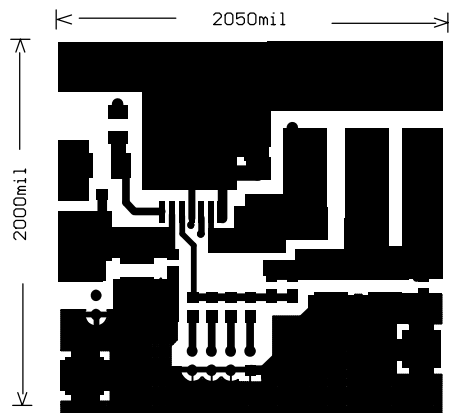

Figure 5c. Top Side Copper

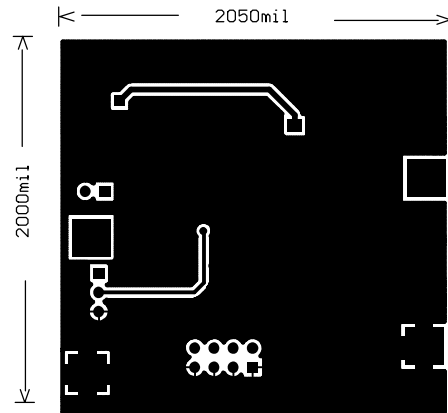

Figure 5d. Bottom Side Copper

## Abbreviated Bill of Material (Critical Components)

Reference	Part Number	Manufacturer	Description	Qty
C1	594D336X0035R2T	Vishay Sprague <sup>1</sup>	33 $\mu$ F 35V	1
C2, C7	VJ0805Y104KXAAB	Vitramon	0.1 $\mu$ F 50V	2
C3	GRM426X7R334K50	Murata	0.33 $\mu$ F, 50V ceramic capacitor	
C4*	Optional		1800pF, 50V ceramic	(1)
C5	594D337X06R3D2T	Vishay Sprague <sup>1</sup>	330 $\mu$ F, 6.3V, tantalum	1
D1	B340A	Diode Inc <sup>2</sup>	Schottky 3A 40V	1
D2	B340A MBRX120	Diode Inc <sup>2</sup> Micro Commercial Component <sup>5</sup>	Schottky 3A 40V Schottky 1A 22V	1
L1	CDRH127-390MC	Sumida <sup>3</sup>	39 $\mu$ H	1
U1	<b>MIC4685BR</b>	Micrel Semiconductor <sup>4</sup>	3A 200kHz SPAK buck regulator	1

<sup>1</sup> Vishay Sprague, Inc., tel: 207-490-7256, <http://www.vishay.com>

<sup>2</sup> Diodes Inc, tel: 805-446-4800, <http://www.diodes.com>

<sup>3</sup> Sumida, tel: 510-668-0660, <http://www.sumida.com>

<sup>4</sup> Micrel, tel: 408-944-0800, <http://www.micrel.com>

<sup>5</sup> Micro Commercial Component, tel: 818-701-4933, <http://www.mccsemi.com>

Package Information

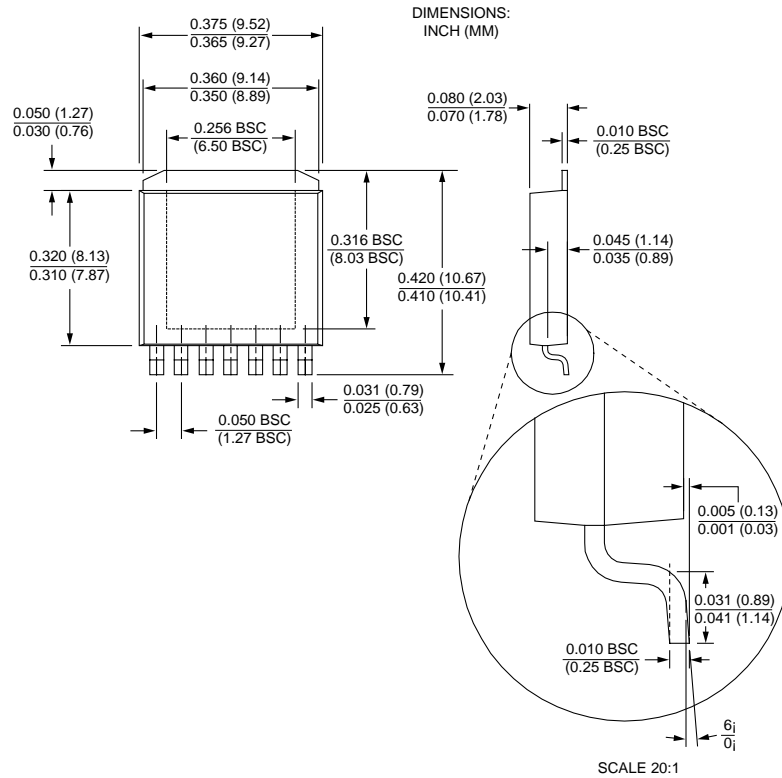

SPAK-07L (R)

MICREL INC. 1849 FORTUNE DRIVE SAN JOSE, CA 95131 USA

TEL + 1 (408) 944-0800 FAX + 1 (408) 944-0970 WEB <http://www.micrel.com>

This information is believed to be accurate and reliable, however no responsibility is assumed by Micrel for its use nor for any infringement of patents or other rights of third parties resulting from its use. No license is granted by implication or otherwise under any patent or patent right of Micrel Inc.

© 2002 Micrel Incorporated