

Complementary Plastic Silicon Power Transistors

... designed for lower power audio amplifier and low current, high-speed switching applications.

- Low Collector-Emitter Sustaining Voltage — $V_{CEO(sus)}$ 60 Vdc (Min) — BD787, BD788
- High Current-Gain — Bandwidth Product — $f_T = 50$ MHz (Min) @ $I_C = 100$ mAdc
- Collector-Emitter Saturation Voltage Specified at 0.5, 1.0, 2.0 and 4.0 Adc

MAXIMUM RATINGS

Rating	Symbol	BD787 BD788	Unit
Collector-Emitter Voltage	V_{CEO}	60	Vdc
Collector-Base Voltage	V_{CBO}	80	Vdc
Emitter-Base Voltage	V_{EBO}	6.0	Vdc
Collector Current — Continuous — Peak	I_C	4.0 8.0	Adc Adc
Base Current	I_B	1.0	Adc
Total Power Dissipation @ $T_C = 25^\circ\text{C}$ Derate Above 25°C	P_D	15 0.12	Watts W/ $^\circ\text{C}$
Operating and Storage Junction Temperature Range	T_J, T_{stg}	-65 to +150	$^\circ\text{C}$

THERMAL CHARACTERISTICS

Characteristic	Symbol	Max	Unit
Thermal Resistance, Junction to Case	$R_{\theta JC}$	8.34	$^\circ\text{C/W}$

**NPN
BD787
PNP
BD788**

**4 AMPERE
POWER TRANSISTORS
COMPLEMENTARY
SILICON
60 VOLTS
15 WATTS**

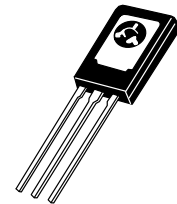

**CASE 77-08
TO-225AA TYPE**

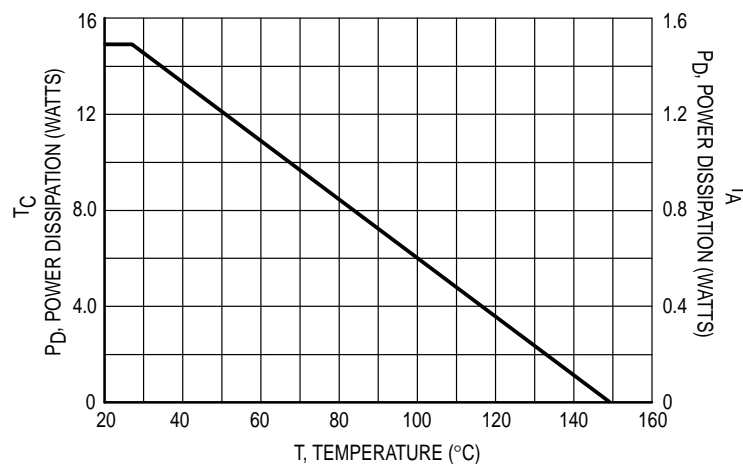

Figure 1. Power Derating

BD787 BD788

*ELECTRICAL CHARACTERISTICS ($T_C = 25^\circ\text{C}$ unless otherwise noted)

Characteristic	Symbol	Min	Max	Unit
OFF CHARACTERISTICS				
Collector–Emitter Sustaining Voltage (1) ($I_C = 10\text{ mAdc}$, $I_B = 0$)	$V_{CEO(sus)}$	60	—	Vdc
Collector Cutoff Current ($V_{CE} = 20\text{ Vdc}$, $I_B = 0$) ($V_{CE} = 30\text{ Vdc}$, $I_B = 0$)	I_{CEO}	—	100	μAdc
Collector Cutoff Current ($V_{CE} = 80\text{ Vdc}$, $V_{BE(off)} = 1.5\text{ Vdc}$) ($V_{CE} = 40\text{ Vdc}$, $V_{BE(off)} = 1.5\text{ Vdc}$, $T_C = 125^\circ\text{C}$)	I_{CEX}	—	1.0 0.1	μAdc mAdc
Emitter Cutoff Current ($V_{EB} = 6.0\text{ Vdc}$, $I_C = 0$)	I_{EBO}	—	1.0	μAdc

ON CHARACTERISTICS(1)

DC Current Gain ($I_C = 200\text{ mAdc}$, $V_{CE} = 3.0\text{ Vdc}$) ($I_C = 1.0\text{ Adc}$, $V_{CE} = 3.0\text{ Vdc}$) ($I_C = 2.0\text{ Adc}$, $V_{CE} = 3.0\text{ Vdc}$) ($I_C = 4.0\text{ Adc}$, $V_{CE} = 3.0\text{ Vdc}$)	h_{FE}	40 25 20 5.0	250 — — —	—
Collector–Emitter Saturation Voltage ($I_C = 500\text{ mAdc}$, $I_B = 50\text{ mAdc}$) ($I_C = 1.0\text{ Adc}$, $I_B = 100\text{ mAdc}$) ($I_C = 2.0\text{ Adc}$, $I_B = 200\text{ mAdc}$) ($I_C = 4.0\text{ Adc}$, $I_B = 800\text{ mAdc}$)	$V_{CE(sat)}$	— — — —	0.4 0.6 0.8 2.5	Vdc
Base–Emitter Saturation Voltage ($I_C = 2.0\text{ Adc}$, $I_B = 200\text{ mAdc}$)	$V_{BE(sat)}$	—	2.0	Vdc
Base–Emitter On Voltage ($I_C = 2.0\text{ Adc}$, $V_{CE} = 3.0\text{ Vdc}$)	$V_{BE(on)}$	—	1.8	Vdc

DYNAMIC CHARACTERISTICS

Current–Gain — Bandwidth Product ($I_C = 100\text{ mAdc}$, $V_{CE} = 10\text{ Vdc}$, $f = 10\text{ MHz}$)	f_T	50	—	MHz
Output Capacitance ($V_{CB} = 10\text{ Vdc}$, $I_C = 0$) ($f = 0.1\text{ MHz}$)	C_{ob}	—	50 70	pF
Small–Signal Current Gain ($I_C = 200\text{ mAdc}$, $V_{CE} = 10\text{ Vdc}$, $f = 1.0\text{ kHz}$)	h_{fe}	10	—	—

* Indicates JEDEC Registered Data

(1) Pulse Test; Pulse Width $\leq 300\ \mu\text{s}$, Duty Cycle $\leq 2.0\%$.

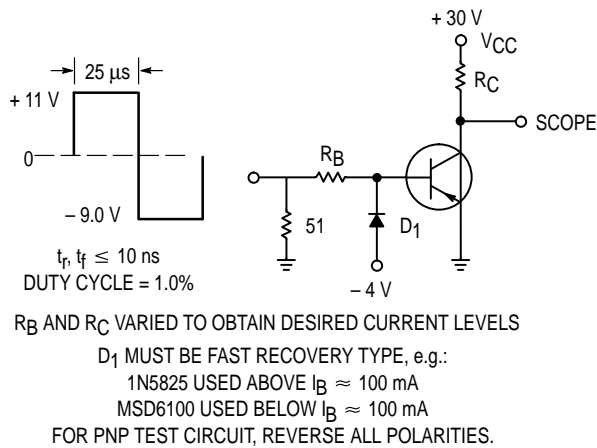

Figure 2. Switching Time Test Circuit

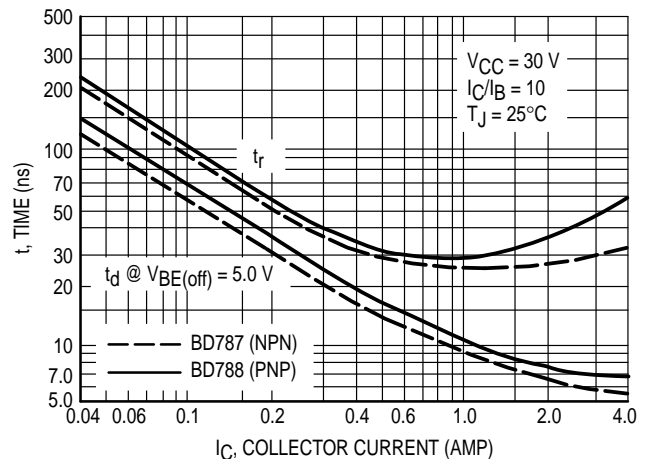

Figure 3. Turn–On Time

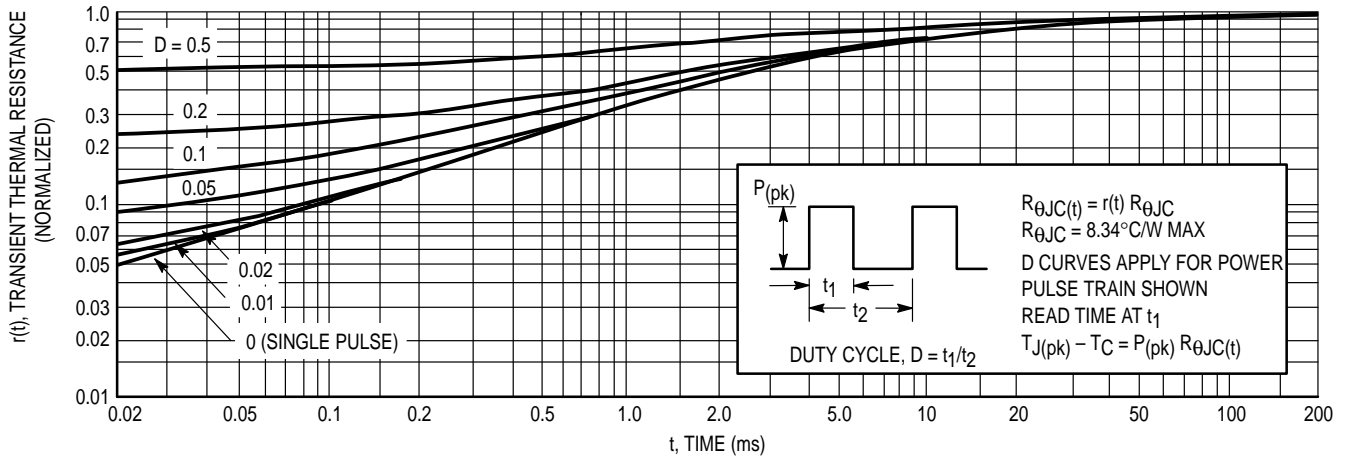

Figure 4. Thermal Response

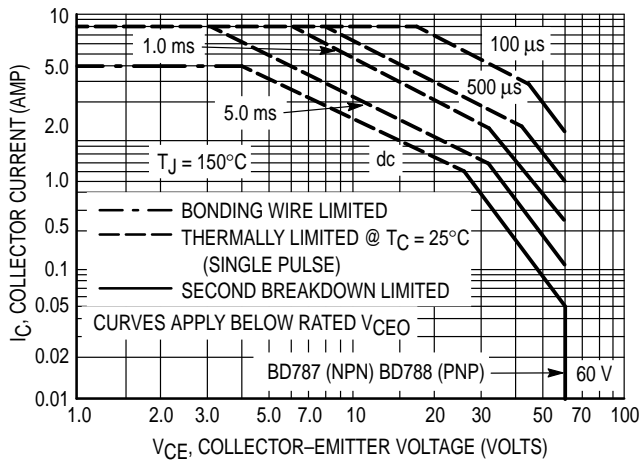

Figure 5. Active Region Safe Operating Area

There are two limitations on the power handling ability of a transistor: average junction temperature and second breakdown. Safe operating area curves indicate $I_C - V_{CE}$ limits of the transistor that must be observed for reliable operation, i.e., the transistor must not be subjected to greater dissipation than the curves indicate.

The data of Figure 5 is based on $T_J(pk) = 150^\circ\text{C}$: T_C is variable depending on conditions. Second breakdown pulse limits are valid for duty cycles to 10% provided $T_J(pk) \leq 150^\circ\text{C}$. $T_J(pk)$ may be calculated from the data in Figure 4. At high case temperatures, thermal limitations will reduce the power that can be handled to values less than the limitations imposed by second breakdown.

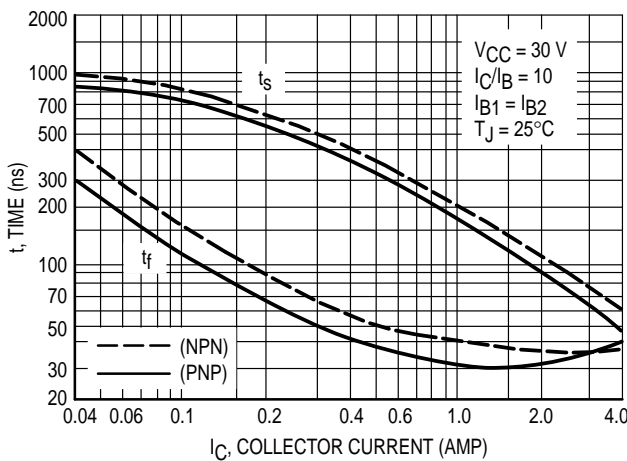

Figure 6. Turn-Off Time

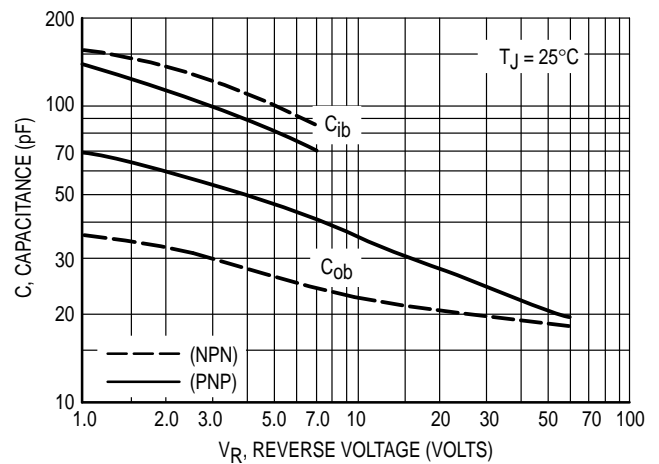

Figure 7. Capacitance

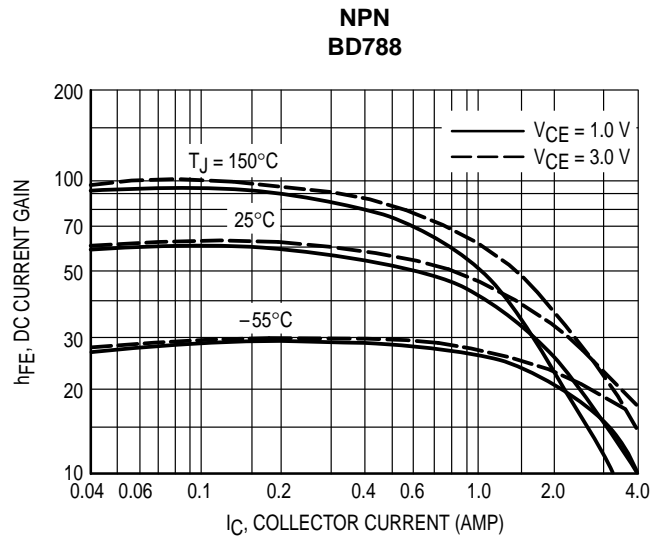
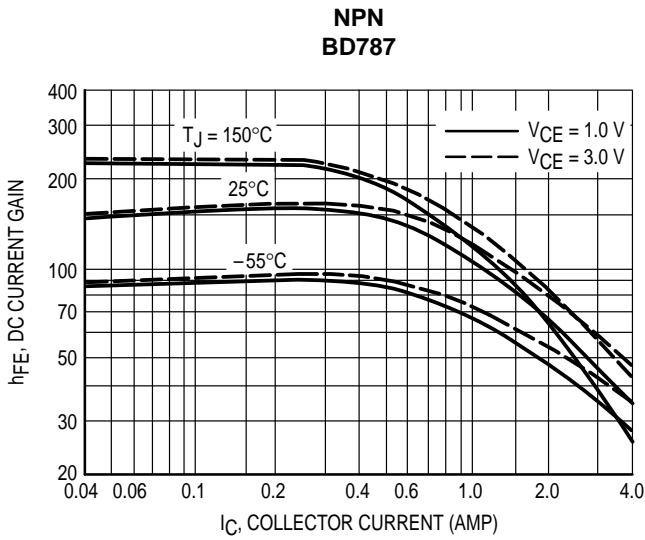

Figure 8. DC Current Gain

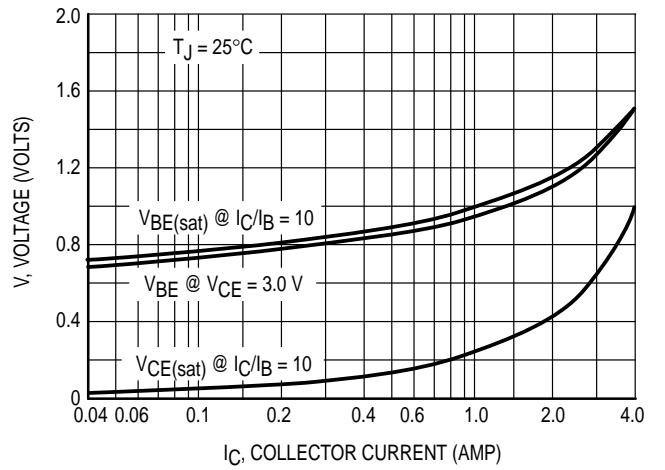
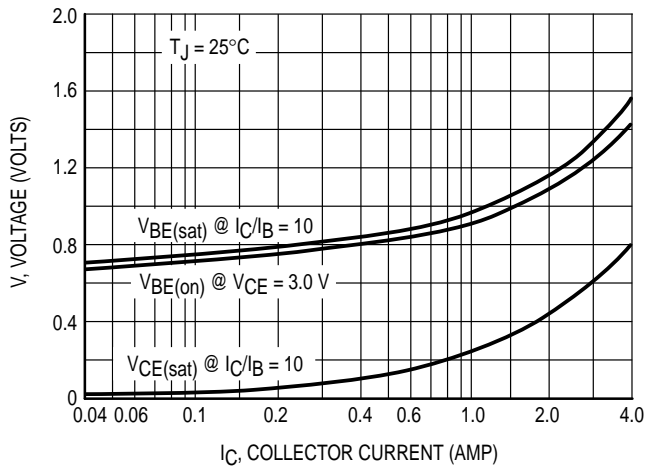

Figure 9. "On" Voltages

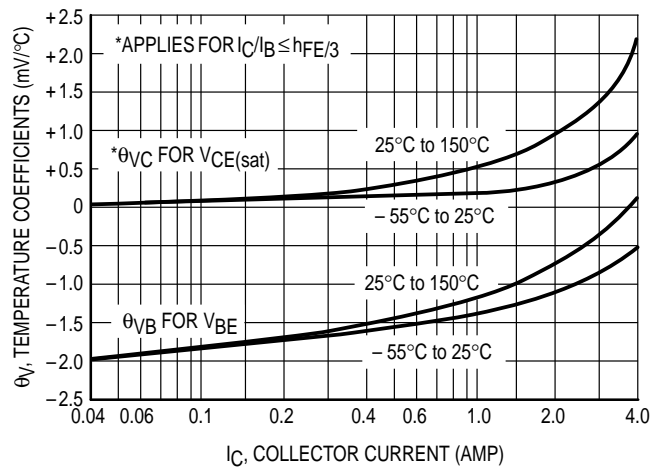
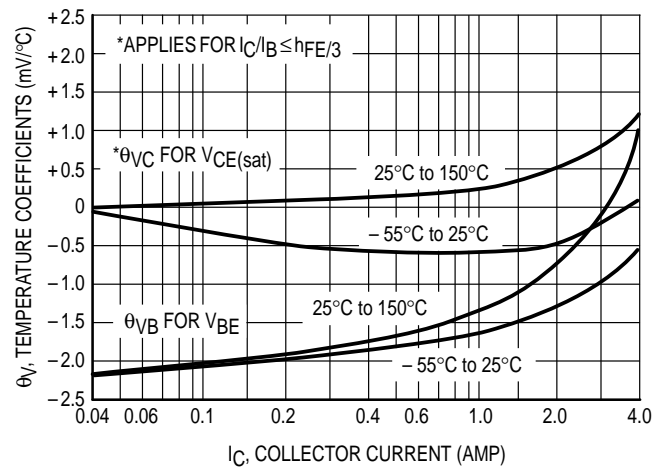
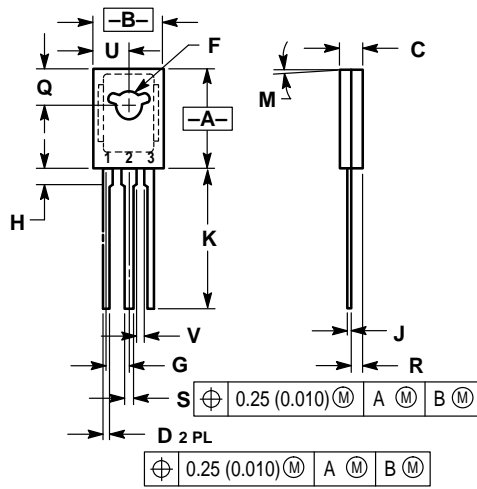

Figure 10. Temperature Coefficients

PACKAGE DIMENSIONS



- NOTES:
 1. DIMENSIONING AND TOLERANCING PER ANSI Y14.5M, 1982.
 2. CONTROLLING DIMENSION: INCH.

DIM	INCHES		MILLIMETERS	
	MIN	MAX	MIN	MAX
A	0.425	0.435	10.80	11.04
B	0.295	0.305	7.50	7.74
C	0.095	0.105	2.42	2.66
D	0.020	0.026	0.51	0.66
F	0.115	0.130	2.93	3.30
G	0.094 BSC		2.39 BSC	
H	0.050	0.095	1.27	2.41
J	0.015	0.025	0.39	0.63
K	0.575	0.655	14.61	16.63
M	5° TYP		5° TYP	
Q	0.148	0.158	3.76	4.01
R	0.045	0.055	1.15	1.39
S	0.025	0.035	0.64	0.88
U	0.145	0.155	3.69	3.93
V	0.040	—	1.02	—

- STYLE 1:
 PIN 1. EMITTER
 2. COLLECTOR
 3. BASE

CASE 77-08
 TO-225AA TYPE
 ISSUE V

Motorola reserves the right to make changes without further notice to any products herein. Motorola makes no warranty, representation or guarantee regarding the suitability of its products for any particular purpose, nor does Motorola assume any liability arising out of the application or use of any product or circuit, and specifically disclaims any and all liability, including without limitation consequential or incidental damages. "Typical" parameters can and do vary in different applications. All operating parameters, including "Typicals" must be validated for each customer application by customer's technical experts. Motorola does not convey any license under its patent rights nor the rights of others. Motorola products are not designed, intended, or authorized for use as components in systems intended for surgical implant into the body, or other applications intended to support or sustain life, or for any other application in which the failure of the Motorola product could create a situation where personal injury or death may occur. Should Buyer purchase or use Motorola products for any such unintended or unauthorized application, Buyer shall indemnify and hold Motorola and its officers, employees, subsidiaries, affiliates, and distributors harmless against all claims, costs, damages, and expenses, and reasonable attorney fees arising out of, directly or indirectly, any claim of personal injury or death associated with such unintended or unauthorized use, even if such claim alleges that Motorola was negligent regarding the design or manufacture of the part. Motorola and  are registered trademarks of Motorola, Inc. Motorola, Inc. is an Equal Opportunity/Affirmative Action Employer.

How to reach us:

USA / EUROPE: Motorola Literature Distribution;
P.O. Box 20912; Phoenix, Arizona 85036. 1-800-441-2447

JAPAN: Nippon Motorola Ltd.; Tatsumi-SPD-JLDC, Toshikatsu Otsuki,
6F Seibu-Butsuryu-Center, 3-14-2 Tatsumi Koto-Ku, Tokyo 135, Japan. 03-3521-8315

MFAX: RMFAX0@email.sps.mot.com - TOUCHTONE (602) 244-6609
INTERNET: <http://Design-NET.com>

HONG KONG: Motorola Semiconductors H.K. Ltd.; 8B Tai Ping Industrial Park,
51 Ting Kok Road, Tai Po, N.T., Hong Kong. 852-26629298

