

**NPN SILICON EPITAXIAL TWIN TRANSISTOR
(WITH BUILT-IN 2 × 2SC5010)
FLAT-LEAD 6-PIN THIN -TYPE ULTRA SUPER MINIMOLD**

FEATURES

- Low noise and high gain
- Operable at low voltage
- Small feedback capacitance: $C_{re} = 0.4$ pF TYP.
- Flat-lead 6-pin thin-type ultra super minimold package
- Built-in 2 transistors (2 × 2SC5010)

ORDERING INFORMATION

Part Number	Package	Quantity	Supplying Form
μPA826TC	Flat-lead 6-pin thin-type ultra super minimold	Loose products (50 pcs)	Embossed tape 8 mm wide. Pin 6 (Q1 Base), Pin 5 (Q2 Emitter), Pin 4 (Q2 Base) face to perforation side of the tape.
μPA826TC-T1		Taping products (3 kp/reel)	

Remark To order evaluation samples, please contact your local NEC sales office. (Part number for sample order: μPA826TC. Unit sample quantity is 50 pcs).

ABSOLUTE MAXIMUM RATINGS (T_A = +25°C)

Parameter	Symbol	Ratings	Unit
Collector to Base Voltage	V _{CB0}	9	V
Collector to Emitter Voltage	V _{CE0}	6	V
Emitter to Base Voltage	V _{EBO}	2	V
Collector Current	I _c	30	mA
Total Power Dissipation	P _T ^{Note}	180 in 1 element 230 in 2 elements	mW
Junction Temperature	T _j	150	°C
Storage Temperature	T _{stg}	-65 to 150	°C

Note Mounted on 1.08 cm² × 1.0 mm glass epoxy substrate.

Caution Electro-static sensitive devices

The information in this document is subject to change without notice. Before using this document, please confirm that this is the latest version.
Not all devices/types available in every country. Please check with local NEC representative for availability and additional information.

ELECTRICAL CHARACTERISTICS (T_A = +25 °C)

Parameter	Symbol	Conditions	MIN.	TYP.	MAX.	Unit
Collector Cutoff Current	I _{CB0}	V _{CB} = 10 V, I _E = 0	–	–	0.1	μA
Emitter Cutoff Current	I _{EB0}	V _{EB} = 1 V, I _C = 0	–	–	0.1	μA
DC Current Gain	h _{FE}	V _{CE} = 3 V, I _C = 7 mA ^{Note 1}	75	–	150	
Gain Bandwidth Product	f _T	V _{CE} = 3 V, I _C = 7 mA, f = 1 GHz	10.0	12.0	–	GHz
Feedback Capacitance	C _{re}	V _{CB} = 3 V, I _E = 0, f = 1 MHz ^{Note 2}	–	0.4	0.7	pF
Insertion Power Gain	S _{21e} ²	V _{CE} = 3 V, I _C = 7 mA, f = 1 GHz	7.0	8.5	–	dB
Noise Figure	NF	V _{CE} = 3 V, I _C = 7 mA, f = 1 GHz	–	1.5	2.5	dB

- Notes 1.** Pulse Measurement: PW ≤ 350 μs, Duty Cycle ≤ 2%
- 2.** Capacitance between collector and base measured with a capacitance meter (auto-balancing bridge method). Emitter should be connected to the guard pin of capacitance meter.

h_{FE} CLASSIFICATION

Rank	KB
Marking	83
h _{FE} Value	75 to 150

TYPICAL CHARACTERISTICS ($T_A = +25\text{ }^\circ\text{C}$)

TOTAL POWER DISSIPATION vs. AMBIENT TEMPERATURE

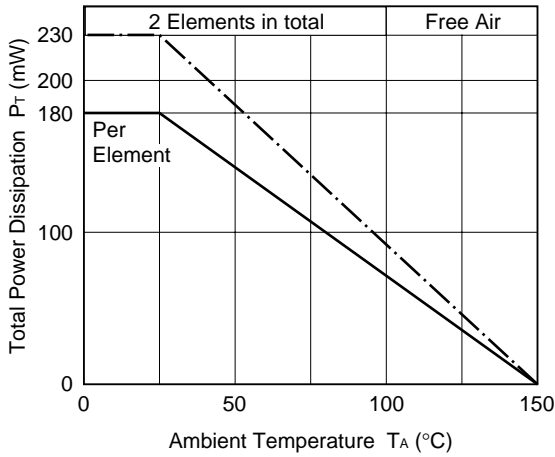

COLLECTOR CURRENT vs. DC BASE VOLTAGE

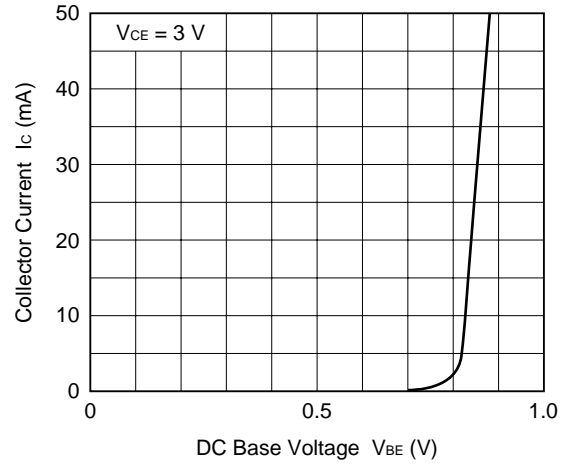

COLLECTOR CURRENT vs. COLLECTOR TO EMITTER VOLTAGE

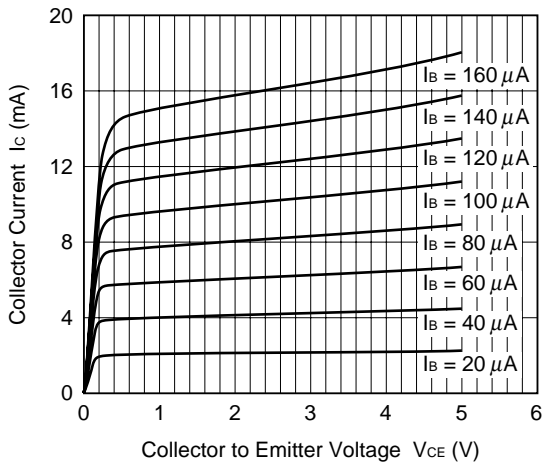

DC CURRENT GAIN vs. COLLECTOR CURRENT

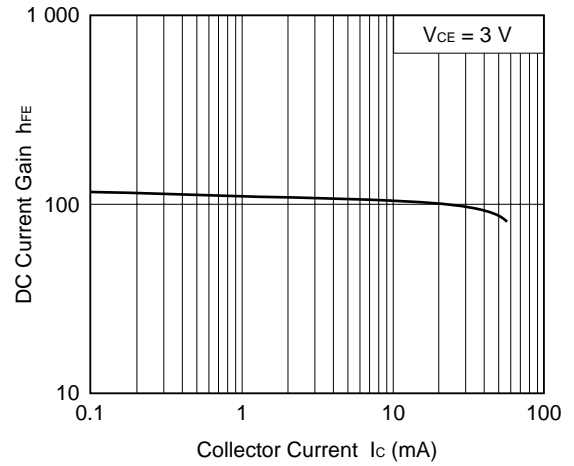

GAIN BANDWIDTH PRODUCT vs. COLLECTOR CURRENT

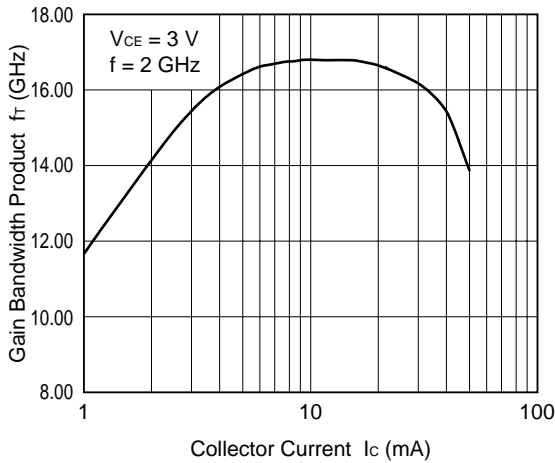

INSERTION POWER GAIN vs. COLLECTOR CURRENT

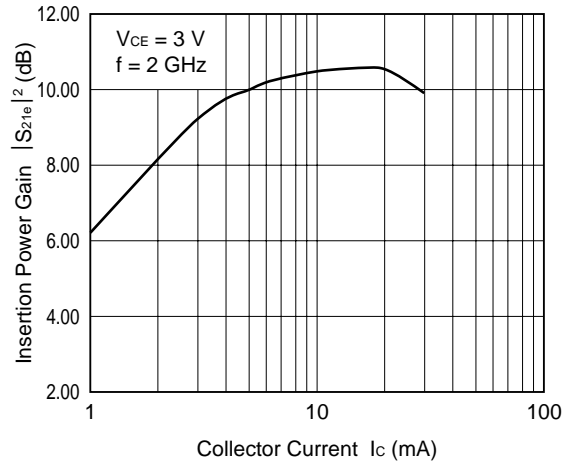

NOISE FIGURE vs. COLLECTOR CURRENT

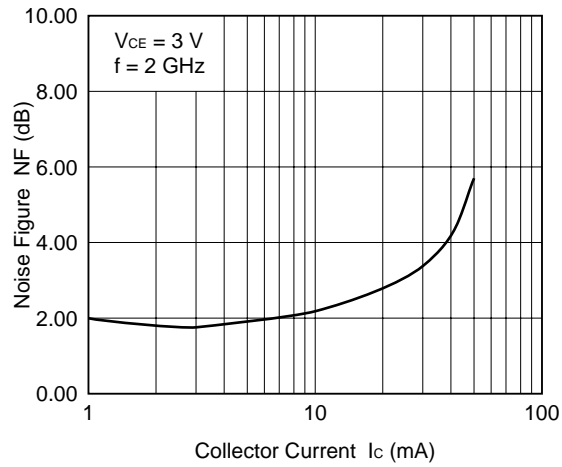

FEEDBACK CAPACITANCE vs. COLLECTOR TO BASE VOLTAGE

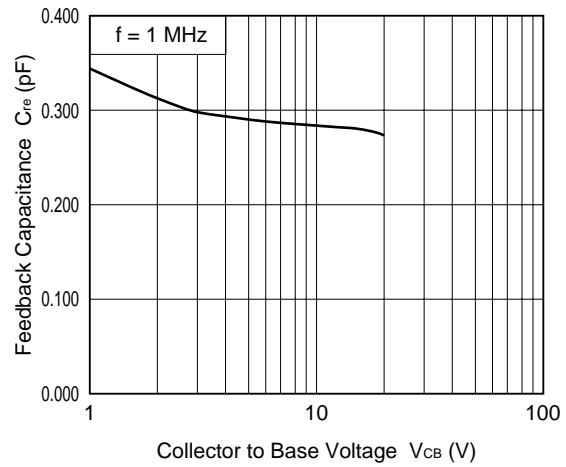

INSERTION POWER GAIN vs. FREQUENCY

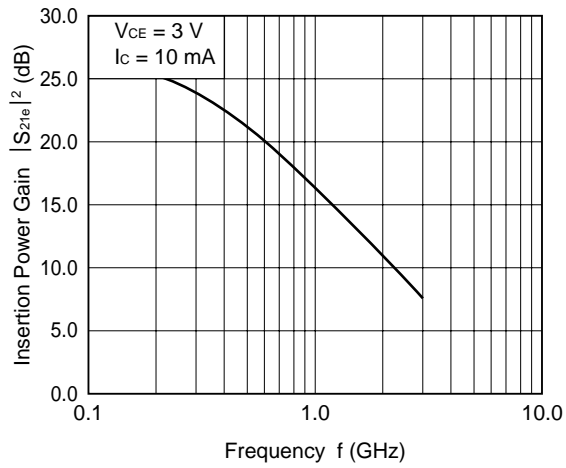

S-PARAMETERS Q1

V_{CE} = 3 V, I_c = 1 mA

FREQUENCY GHz	S ₁₁		S ₂₁		S ₁₂		S ₂₂	
	MAG.	ANG.	MAG.	ANG.	MAG.	ANG.	MAG.	ANG.
0.1	0.962	-14.0	3.900	166.5	0.031	34.7	1.012	-9.6
0.2	0.939	-25.6	3.769	154.0	0.044	70.0	0.986	-19.1
0.3	0.925	-38.2	3.657	142.4	0.058	61.6	0.980	-28.7
0.4	0.900	-51.3	3.558	130.1	0.075	48.7	0.965	-38.0
0.5	0.887	-63.0	3.505	118.5	0.089	39.6	0.941	-47.0
0.6	0.841	-75.3	3.365	106.7	0.105	30.7	0.918	-56.1
0.7	0.809	-88.2	3.262	94.8	0.115	20.4	0.889	-64.7
0.8	0.774	-100.0	3.176	83.8	0.127	10.5	0.865	-73.4
0.9	0.737	-111.6	3.064	72.8	0.140	3.2	0.838	-82.0
1.0	0.695	-123.9	2.954	61.9	0.144	-6.4	0.806	-90.6
1.1	0.656	-135.9	2.843	51.6	0.155	-15.5	0.775	-98.6
1.2	0.622	-147.4	2.760	41.1	0.162	-23.4	0.753	-106.5
1.3	0.591	-159.8	2.660	30.8	0.170	-30.9	0.726	-114.6
1.4	0.557	-171.5	2.579	21.0	0.175	-38.4	0.705	-122.4
1.5	0.528	176.8	2.491	11.1	0.178	-46.0	0.679	-130.1
1.6	0.501	164.3	2.414	1.0	0.185	-53.6	0.655	-137.7
1.7	0.477	151.6	2.333	-8.7	0.186	-61.2	0.635	-145.6
1.8	0.453	139.1	2.267	-18.1	0.191	-68.4	0.613	-153.2
1.9	0.434	126.6	2.196	-27.3	0.196	-75.6	0.594	-160.6
2.0	0.416	114.2	2.120	-37.0	0.196	-82.6	0.573	-168.1
2.1	0.400	100.9	2.060	-46.1	0.197	-89.9	0.557	-175.3
2.2	0.389	88.4	1.988	-55.7	0.199	-95.5	0.535	176.8
2.3	0.381	75.3	1.930	-64.5	0.197	-102.9	0.515	169.2
2.4	0.372	62.9	1.866	-73.7	0.200	-108.7	0.494	161.7
2.5	0.364	50.9	1.801	-82.2	0.200	-115.5	0.478	154.7
2.6	0.369	39.1	1.753	-90.6	0.203	-119.5	0.468	147.9
2.7	0.371	27.4	1.706	-99.1	0.202	-126.2	0.465	140.3
2.8	0.374	16.2	1.662	-107.7	0.204	-132.3	0.456	131.9
2.9	0.380	5.3	1.622	-115.8	0.203	-138.6	0.445	124.1
3.0	0.387	-5.7	1.575	-124.6	0.207	-144.4	0.438	115.8

V_{CE} = 3 V, I_c = 3 mA

FREQUENCY GHz	S ₁₁		S ₂₁		S ₁₂		S ₂₂	
	MAG.	ANG.	MAG.	ANG.	MAG.	ANG.	MAG.	ANG.
0.1	0.897	-19.4	9.548	161.9	0.017	64.0	0.985	-13.5
0.2	0.852	-34.6	8.940	146.2	0.038	62.6	0.955	-25.7
0.3	0.811	-50.0	8.404	131.7	0.059	54.4	0.918	-37.0
0.4	0.753	-66.7	7.863	117.0	0.066	44.1	0.864	-48.0
0.5	0.693	-81.0	7.381	103.8	0.072	36.3	0.804	-58.1
0.6	0.630	-94.7	6.795	91.1	0.082	25.6	0.754	-67.8
0.7	0.572	-109.1	6.304	78.9	0.088	14.9	0.707	-76.1
0.8	0.520	-121.6	5.842	67.8	0.095	7.6	0.662	-84.3
0.9	0.477	-135.0	5.452	56.8	0.107	2.4	0.623	-92.6
1.0	0.430	-147.6	5.076	46.4	0.110	-5.0	0.587	-100.0
1.1	0.396	-160.5	4.745	36.3	0.117	-12.0	0.559	-107.5
1.2	0.364	-173.4	4.475	26.7	0.122	-18.8	0.529	-114.8
1.3	0.338	173.4	4.206	17.2	0.129	-26.4	0.504	-122.1
1.4	0.313	160.3	3.973	8.1	0.133	-32.3	0.481	-129.2
1.5	0.298	147.3	3.765	-0.9	0.137	-38.6	0.463	-136.2
1.6	0.281	133.4	3.574	-9.9	0.144	-44.6	0.443	-143.5
1.7	0.271	120.0	3.416	-18.8	0.147	-50.0	0.425	-150.7
1.8	0.262	106.3	3.252	-27.4	0.154	-56.2	0.406	-157.9
1.9	0.258	93.2	3.122	-36.0	0.159	-63.2	0.393	-165.3
2.0	0.255	80.2	2.976	-44.6	0.165	-68.0	0.376	-172.0
2.1	0.258	66.4	2.868	-52.9	0.168	-75.3	0.361	-179.6
2.2	0.260	54.1	2.743	-61.4	0.172	-81.5	0.348	173.0
2.3	0.265	42.4	2.644	-69.6	0.176	-87.4	0.334	165.3
2.4	0.275	31.1	2.548	-77.8	0.183	-93.4	0.321	157.6
2.5	0.280	19.4	2.455	-85.9	0.188	-99.6	0.308	149.7
2.6	0.293	9.2	2.380	-94.1	0.194	-104.8	0.298	141.6
2.7	0.301	-1.5	2.301	-101.8	0.198	-110.8	0.285	133.8
2.8	0.312	-11.1	2.223	-109.9	0.203	-118.0	0.274	125.6
2.9	0.324	-20.5	2.163	-117.8	0.208	-123.6	0.266	116.6
3.0	0.335	-29.5	2.090	-125.7	0.214	-129.9	0.257	108.0

V_{CE} = 3 V, I_C = 5 mA

FREQUENCY GHz	S ₁₁		S ₂₁		S ₁₂		S ₂₂	
	MAG.	ANG.	MAG.	ANG.	MAG.	ANG.	MAG.	ANG.
0.1	0.826	-21.1	14.048	158.2	0.034	61.3	0.983	-15.5
0.2	0.768	-41.4	12.791	140.1	0.038	63.4	0.917	-29.2
0.3	0.698	-59.8	11.643	123.8	0.048	50.7	0.848	-42.4
0.4	0.621	-76.6	10.439	108.1	0.054	41.1	0.770	-53.7
0.5	0.550	-92.4	9.468	94.4	0.062	35.2	0.699	-63.0
0.6	0.481	-105.8	8.453	81.9	0.075	23.9	0.643	-72.1
0.7	0.424	-120.4	7.645	70.2	0.077	16.2	0.590	-79.7
0.8	0.378	-134.0	6.978	59.2	0.085	13.4	0.549	-87.0
0.9	0.337	-146.8	6.337	49.0	0.092	5.2	0.514	-94.7
1.0	0.301	-159.9	5.839	39.1	0.099	-1.0	0.484	-101.5
1.1	0.271	-173.9	5.407	29.6	0.103	-6.9	0.455	-108.4
1.2	0.248	172.7	5.042	20.6	0.112	-12.8	0.435	-114.4
1.3	0.232	159.0	4.697	11.6	0.116	-19.1	0.415	-121.9
1.4	0.217	145.0	4.423	2.9	0.124	-24.5	0.396	-128.5
1.5	0.210	131.7	4.184	-5.7	0.130	-30.4	0.383	-135.8
1.6	0.200	115.3	3.921	-14.2	0.135	-36.9	0.365	-142.3
1.7	0.200	102.9	3.724	-22.7	0.143	-43.1	0.349	-149.7
1.8	0.199	88.9	3.544	-31.1	0.152	-49.2	0.335	-156.6
1.9	0.202	75.8	3.400	-38.9	0.156	-55.4	0.322	-163.7
2.0	0.207	62.7	3.229	-47.3	0.162	-61.6	0.312	-171.0
2.1	0.216	49.7	3.095	-55.3	0.168	-68.4	0.296	-178.7
2.2	0.223	38.6	2.968	-63.7	0.174	-73.7	0.283	-173.5
2.3	0.233	28.1	2.860	-71.4	0.180	-80.5	0.272	-166.3
2.4	0.244	17.2	2.751	-79.4	0.187	-87.0	0.261	-158.1
2.5	0.254	6.4	2.652	-87.3	0.193	-92.9	0.247	-149.5
2.6	0.266	-2.5	2.567	-95.1	0.199	-99.3	0.238	-141.5
2.7	0.281	-11.9	2.471	-102.7	0.206	-105.5	0.228	-132.0
2.8	0.290	-20.6	2.392	-110.5	0.212	-112.9	0.221	-123.1
2.9	0.301	-29.6	2.321	-118.3	0.218	-118.4	0.209	-114.6
3.0	0.317	-37.3	2.251	-125.9	0.225	-125.7	0.203	-104.7

V_{CE} = 3 V, I_C = 10 mA

FREQUENCY GHz	S ₁₁		S ₂₁		S ₁₂		S ₂₂	
	MAG.	ANG.	MAG.	ANG.	MAG.	ANG.	MAG.	ANG.
0.1	0.733	-29.0	21.168	152.6	0.019	22.5	0.956	-19.9
0.2	0.629	-52.2	18.320	130.8	0.033	55.6	0.842	-36.2
0.3	0.531	-73.1	15.647	112.6	0.046	47.9	0.739	-49.3
0.4	0.433	-91.9	13.294	96.9	0.046	38.3	0.638	-59.6
0.5	0.368	-107.2	11.506	83.8	0.049	39.7	0.564	-67.2
0.6	0.314	-122.4	9.992	71.9	0.065	28.2	0.514	-74.7
0.7	0.270	-137.0	8.802	61.3	0.068	23.4	0.469	-80.8
0.8	0.237	-152.3	7.864	51.2	0.073	15.0	0.432	-87.6
0.9	0.210	-165.9	7.091	41.6	0.085	11.8	0.408	-94.1
1.0	0.188	178.6	6.459	32.4	0.090	6.1	0.386	-99.7
1.1	0.171	163.3	5.944	23.5	0.095	0.4	0.368	-106.8
1.2	0.160	148.5	5.495	15.0	0.108	-6.2	0.352	-113.0
1.3	0.160	133.4	5.104	6.4	0.110	-12.2	0.337	-119.9
1.4	0.153	117.1	4.780	-1.8	0.116	-18.5	0.323	-126.2
1.5	0.158	102.8	4.493	-9.9	0.123	-25.1	0.309	-133.5
1.6	0.163	89.3	4.226	-18.5	0.133	-30.2	0.298	-140.5
1.7	0.168	76.9	4.010	-26.2	0.142	-37.7	0.286	-148.0
1.8	0.175	64.2	3.788	-34.4	0.147	-42.9	0.277	-155.0
1.9	0.186	52.7	3.622	-41.8	0.150	-50.5	0.264	-162.5
2.0	0.196	41.6	3.433	-50.0	0.162	-56.5	0.253	-169.5
2.1	0.209	30.7	3.296	-57.9	0.168	-63.1	0.241	-177.5
2.2	0.220	20.8	3.152	-65.9	0.176	-69.6	0.230	-174.4
2.3	0.231	11.5	3.031	-73.5	0.180	-75.9	0.217	-166.3
2.4	0.245	2.5	2.913	-81.1	0.189	-82.3	0.209	-158.1
2.5	0.258	-6.2	2.803	-88.9	0.197	-89.4	0.197	-148.9
2.6	0.270	-14.0	2.711	-96.4	0.203	-96.1	0.188	-139.2
2.7	0.284	-22.6	2.615	-104.1	0.212	-101.9	0.177	-130.3
2.8	0.293	-30.2	2.529	-111.6	0.216	-108.9	0.172	-121.0
2.9	0.305	-38.8	2.453	-119.2	0.222	-115.3	0.161	-110.5
3.0	0.321	-45.8	2.367	-126.8	0.232	-122.2	0.154	-100.0

S-PARAMETERS Q2

V_{CE} = 3 V, I_c = 1 mA

FREQUENCY GHz	S ₁₁		S ₂₁		S ₁₂		S ₂₂	
	MAG.	ANG.	MAG.	ANG.	MAG.	ANG.	MAG.	ANG.
0.1	0.970	-13.8	4.079	166.5	0.029	51.6	1.002	-9.5
0.2	0.946	-25.9	3.922	153.7	0.040	68.9	0.984	-19.3
0.3	0.926	-38.7	3.809	142.2	0.053	60.3	0.974	-29.0
0.4	0.902	-51.6	3.696	129.7	0.069	49.1	0.960	-38.3
0.5	0.878	-64.1	3.620	117.8	0.088	40.2	0.931	-47.3
0.6	0.847	-76.1	3.484	106.0	0.101	30.8	0.906	-56.1
0.7	0.802	-88.4	3.363	94.4	0.112	22.0	0.880	-64.7
0.8	0.769	-100.4	3.229	83.4	0.122	12.2	0.850	-73.5
0.9	0.737	-112.0	3.120	72.5	0.137	3.4	0.824	-82.0
1.0	0.700	-123.5	3.018	62.0	0.141	-4.9	0.794	-90.0
1.1	0.664	-135.2	2.897	51.5	0.151	-12.8	0.767	-98.2
1.2	0.633	-146.6	2.810	41.3	0.156	-21.6	0.738	-105.9
1.3	0.606	-158.3	2.706	31.3	0.164	-30.1	0.716	-113.9
1.4	0.574	-169.4	2.617	21.6	0.168	-37.7	0.690	-121.2
1.5	0.545	-179.3	2.519	11.9	0.173	-45.0	0.665	-129.1
1.6	0.526	167.4	2.445	1.9	0.179	-51.8	0.642	-136.5
1.7	0.500	156.0	2.361	-7.5	0.182	-58.7	0.623	-144.4
1.8	0.479	144.8	2.291	-16.5	0.184	-65.7	0.601	-151.9
1.9	0.464	133.0	2.224	-25.9	0.188	-73.4	0.580	-159.2
2.0	0.445	121.5	2.152	-35.1	0.192	-79.5	0.568	-166.5
2.1	0.428	109.3	2.091	-44.2	0.191	-87.0	0.543	-173.5
2.2	0.418	98.5	2.028	-53.4	0.194	-92.4	0.532	-178.7
2.3	0.408	87.2	1.970	-62.0	0.196	-99.0	0.511	-171.2
2.4	0.401	75.6	1.916	-70.8	0.197	-105.2	0.498	-163.5
2.5	0.392	64.4	1.862	-79.5	0.200	-111.9	0.482	-155.8
2.6	0.393	52.9	1.814	-88.1	0.202	-117.3	0.469	-147.8
2.7	0.388	42.2	1.763	-96.8	0.204	-122.7	0.456	-139.9
2.8	0.387	32.0	1.715	-105.1	0.207	-129.6	0.444	-132.4
2.9	0.385	21.2	1.671	-113.3	0.207	-135.3	0.430	-124.4
3.0	0.387	10.9	1.628	-121.8	0.210	-140.8	0.421	-116.1

V_{CE} = 3 V, I_c = 3 mA

FREQUENCY GHz	S ₁₁		S ₂₁		S ₁₂		S ₂₂	
	MAG.	ANG.	MAG.	ANG.	MAG.	ANG.	MAG.	ANG.
0.1	0.884	-18.2	9.862	161.4	0.025	51.3	0.990	-13.2
0.2	0.854	-34.8	9.160	145.9	0.033	71.8	0.950	-25.5
0.3	0.811	-50.9	8.603	131.2	0.056	47.3	0.914	-37.0
0.4	0.747	-66.6	8.001	116.6	0.057	44.8	0.853	-48.2
0.5	0.695	-81.2	7.497	103.4	0.075	36.0	0.798	-58.0
0.6	0.631	-94.9	6.889	90.5	0.083	28.0	0.739	-66.8
0.7	0.575	-108.5	6.360	78.5	0.087	18.2	0.692	-75.3
0.8	0.531	-121.2	5.887	67.6	0.099	9.6	0.648	-83.3
0.9	0.484	-133.6	5.475	57.0	0.102	1.8	0.609	-91.3
1.0	0.449	-145.6	5.118	46.6	0.106	-3.9	0.574	-98.2
1.1	0.414	-158.0	4.781	36.7	0.113	-9.9	0.543	-105.7
1.2	0.386	-169.8	4.498	27.2	0.121	-18.4	0.516	-112.7
1.3	0.362	178.3	4.232	17.9	0.127	-22.6	0.493	-119.6
1.4	0.339	166.5	4.008	8.9	0.131	-29.9	0.468	-126.5
1.5	0.324	154.5	3.795	-0.1	0.135	-35.5	0.448	-133.2
1.6	0.309	142.0	3.602	-9.0	0.141	-41.7	0.429	-140.5
1.7	0.301	130.0	3.440	-17.7	0.149	-48.2	0.413	-147.4
1.8	0.286	118.9	3.274	-25.9	0.150	-54.2	0.392	-153.8
1.9	0.280	106.7	3.143	-34.6	0.157	-59.9	0.379	-160.8
2.0	0.277	94.6	3.014	-43.0	0.162	-65.5	0.364	-167.8
2.1	0.274	82.5	2.893	-51.3	0.166	-73.1	0.346	-174.6
2.2	0.273	71.2	2.788	-59.7	0.174	-78.3	0.334	-177.5
2.3	0.276	60.5	2.685	-67.7	0.178	-84.6	0.319	-170.4
2.4	0.276	49.5	2.587	-75.9	0.182	-90.5	0.305	-163.3
2.5	0.279	38.2	2.502	-83.9	0.189	-96.3	0.292	-155.4
2.6	0.287	28.6	2.423	-91.9	0.193	-102.4	0.279	-147.8
2.7	0.289	17.9	2.350	-99.9	0.201	-108.7	0.267	-139.4
2.8	0.297	8.4	2.273	-107.8	0.207	-115.0	0.257	-131.4
2.9	0.303	-0.8	2.208	-115.5	0.210	-120.8	0.243	-123.9
3.0	0.313	-10.1	2.145	-123.3	0.220	-127.3	0.235	-114.8

V_{CE} = 3 V, I_C = 5 mA

FREQUENCY GHz	S ₁₁		S ₂₁		S ₁₂		S ₂₂	
	MAG.	ANG.	MAG.	ANG.	MAG.	ANG.	MAG.	ANG.
0.1	0.844	-22.4	13.863	158.4	0.032	25.1	0.989	-16.2
0.2	0.781	-41.1	12.602	140.6	0.032	63.4	0.916	-29.6
0.3	0.714	-58.5	11.489	124.4	0.046	50.1	0.846	-42.4
0.4	0.635	-76.3	10.332	108.8	0.057	42.6	0.775	-53.2
0.5	0.573	-91.3	9.395	95.1	0.062	33.1	0.696	-62.8
0.6	0.506	-105.5	8.394	82.7	0.072	28.2	0.642	-71.0
0.7	0.454	-119.5	7.618	71.0	0.077	18.4	0.591	-78.8
0.8	0.406	-132.3	6.913	60.0	0.084	10.4	0.548	-85.6
0.9	0.371	-144.2	6.330	50.2	0.093	8.1	0.512	-92.9
1.0	0.340	-156.8	5.828	40.4	0.099	-0.7	0.480	-99.8
1.1	0.310	-169.6	5.402	30.8	0.102	-5.6	0.453	-106.5
1.2	0.286	179.3	5.038	21.9	0.108	-12.4	0.429	-112.6
1.3	0.273	166.3	4.710	12.9	0.116	-17.8	0.411	-119.6
1.4	0.257	154.4	4.429	4.3	0.120	-24.7	0.391	-125.9
1.5	0.248	141.9	4.176	-4.2	0.130	-29.9	0.373	-132.9
1.6	0.238	129.3	3.957	-12.9	0.133	-36.7	0.355	-138.9
1.7	0.236	117.4	3.764	-21.2	0.141	-42.0	0.340	-146.5
1.8	0.232	105.0	3.582	-29.4	0.146	-48.4	0.329	-152.7
1.9	0.233	93.6	3.431	-37.6	0.154	-54.6	0.314	-159.6
2.0	0.229	81.8	3.262	-45.5	0.162	-60.1	0.301	-166.4
2.1	0.233	69.7	3.133	-53.7	0.165	-67.4	0.284	-173.4
2.2	0.236	59.9	3.007	-61.9	0.174	-72.8	0.272	-179.8
2.3	0.242	48.8	2.896	-69.6	0.180	-79.0	0.255	-171.7
2.4	0.246	38.0	2.793	-77.6	0.185	-85.5	0.246	-165.3
2.5	0.250	28.1	2.688	-85.3	0.191	-92.6	0.234	-157.2
2.6	0.262	18.8	2.606	-93.3	0.199	-98.4	0.222	-149.1
2.7	0.271	8.8	2.530	-101.1	0.205	-104.1	0.211	-140.4
2.8	0.279	0.1	2.447	-108.7	0.212	-111.3	0.201	-132.6
2.9	0.289	-9.4	2.366	-116.8	0.217	-117.1	0.187	-124.7
3.0	0.299	-17.6	2.298	-124.2	0.224	-123.5	0.181	-115.3

V_{CE} = 3 V, I_C = 10 mA

FREQUENCY GHz	S ₁₁		S ₂₁		S ₁₂		S ₂₂	
	MAG.	ANG.	MAG.	ANG.	MAG.	ANG.	MAG.	ANG.
0.1	0.722	-28.8	21.436	152.5	0.023	23.1	0.955	-21.3
0.2	0.625	-52.9	18.522	130.8	0.036	60.5	0.836	-36.4
0.3	0.535	-73.7	15.755	112.8	0.038	46.3	0.726	-49.2
0.4	0.443	-91.6	13.325	97.0	0.047	41.9	0.630	-58.7
0.5	0.388	-108.2	11.605	83.9	0.052	33.9	0.555	-66.8
0.6	0.330	-121.2	10.044	72.5	0.062	32.8	0.506	-73.1
0.7	0.291	-136.6	8.855	61.4	0.066	21.3	0.461	-79.8
0.8	0.263	-149.1	7.909	51.6	0.075	15.9	0.424	-85.8
0.9	0.236	-162.4	7.131	42.3	0.083	12.1	0.402	-91.8
1.0	0.215	-175.4	6.521	33.2	0.088	7.1	0.375	-97.2
1.1	0.205	171.2	5.982	24.4	0.095	0.2	0.356	-103.4
1.2	0.194	157.8	5.546	15.9	0.102	-5.7	0.337	-109.3
1.3	0.187	145.7	5.160	7.6	0.110	-10.8	0.323	-116.2
1.4	0.182	133.0	4.823	-0.6	0.116	-18.0	0.308	-121.3
1.5	0.183	120.7	4.518	-8.8	0.123	-23.1	0.299	-128.5
1.6	0.182	108.1	4.283	-16.8	0.128	-30.1	0.281	-134.7
1.7	0.185	97.0	4.049	-24.7	0.140	-35.9	0.271	-142.0
1.8	0.188	85.5	3.842	-32.6	0.145	-41.3	0.259	-148.0
1.9	0.196	74.2	3.670	-40.4	0.151	-48.9	0.246	-154.8
2.0	0.202	64.0	3.508	-48.5	0.160	-55.0	0.234	-161.9
2.1	0.207	53.0	3.356	-56.2	0.167	-62.4	0.222	-168.6
2.2	0.215	43.4	3.207	-64.3	0.173	-68.3	0.210	-175.6
2.3	0.225	34.3	3.092	-71.8	0.182	-74.4	0.195	-176.5
2.4	0.233	24.5	2.977	-79.4	0.189	-81.1	0.187	-169.8
2.5	0.240	15.2	2.869	-87.0	0.195	-87.5	0.173	-161.8
2.6	0.254	6.7	2.764	-94.8	0.202	-94.5	0.161	-152.6
2.7	0.263	-1.8	2.669	-102.3	0.209	-100.5	0.150	-144.6
2.8	0.274	-10.0	2.587	-109.9	0.218	-107.5	0.140	-136.2
2.9	0.282	-18.0	2.507	-117.3	0.223	-113.3	0.124	-128.6
3.0	0.292	-26.1	2.432	-125.0	0.231	-120.3	0.119	-118.4

PACKAGE DIMENSIONS

FLAT-LEAD 6 PIN THIN-TYPE ULTRA SUPER MINIMOLD (UNIT: mm)

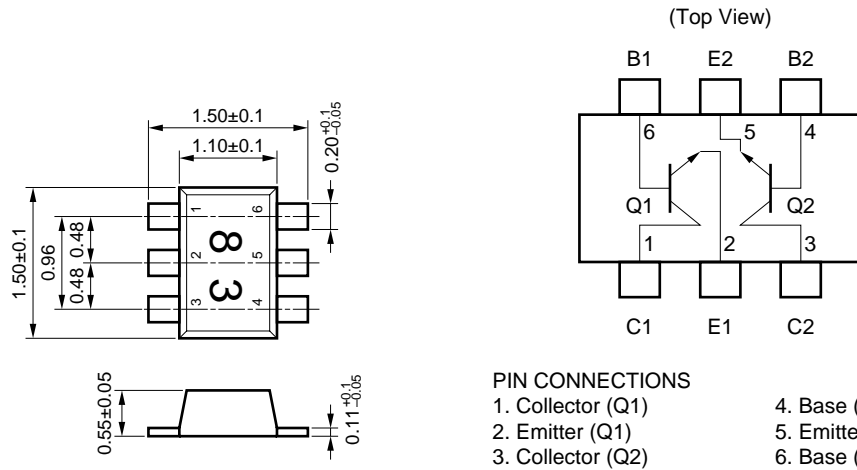

[MEMO]

[MEMO]

- **The information in this document is subject to change without notice. Before using this document, please confirm that this is the latest version.**
 - No part of this document may be copied or reproduced in any form or by any means without the prior written consent of NEC Corporation. NEC Corporation assumes no responsibility for any errors which may appear in this document.
 - NEC Corporation does not assume any liability for infringement of patents, copyrights or other intellectual property rights of third parties by or arising from use of a device described herein or any other liability arising from use of such device. No license, either express, implied or otherwise, is granted under any patents, copyrights or other intellectual property rights of NEC Corporation or others.
 - Descriptions of circuits, software, and other related information in this document are provided for illustrative purposes in semiconductor product operation and application examples. The incorporation of these circuits, software, and information in the design of the customer's equipment shall be done under the full responsibility of the customer. NEC Corporation assumes no responsibility for any losses incurred by the customer or third parties arising from the use of these circuits, software, and information.
 - While NEC Corporation has been making continuous effort to enhance the reliability of its semiconductor devices, the possibility of defects cannot be eliminated entirely. To minimize risks of damage or injury to persons or property arising from a defect in an NEC semiconductor device, customers must incorporate sufficient safety measures in its design, such as redundancy, fire-containment, and anti-failure features.
 - NEC devices are classified into the following three quality grades:
"Standard", "Special", and "Specific". The Specific quality grade applies only to devices developed based on a customer designated "quality assurance program" for a specific application. The recommended applications of a device depend on its quality grade, as indicated below. Customers must check the quality grade of each device before using it in a particular application.
 - Standard: Computers, office equipment, communications equipment, test and measurement equipment, audio and visual equipment, home electronic appliances, machine tools, personal electronic equipment and industrial robots
 - Special: Transportation equipment (automobiles, trains, ships, etc.), traffic control systems, anti-disaster systems, anti-crime systems, safety equipment and medical equipment (not specifically designed for life support)
 - Specific: Aircraft, aerospace equipment, submersible repeaters, nuclear reactor control systems, life support systems or medical equipment for life support, etc.
- The quality grade of NEC devices is "Standard" unless otherwise specified in NEC's Data Sheets or Data Books. If customers intend to use NEC devices for applications other than those specified for Standard quality grade, they should contact an NEC sales representative in advance.