

LP3992

Micropower 1.5V CMOS Voltage Regulator with Shutdown Control

General Description

The LP3992 regulator is designed to meet the requirements of portable, battery-powered systems providing an accurate output voltage, low noise, and low quiescent current. Battery life will be prolonged by the ability of the LP3992 to provide a 1.5V output from the low input voltage of 1.9V. Additionally, when switched to a shutdown mode via a logic signal at the shutdown pin, the power consumption is reduced to virtually zero. The LP3992 also features short-circuit and thermal-shutdown protection.

The LP3992 is designed to be stable with space saving ceramic capacitors as small as 1.0 μ F.

The device is available in an SOT23-5 package. Performance is specified for a -40°C to 125°C temperature range.

For output voltages other than 1.5V and alternative package options, please contact your local NSC sales office.

Key Specifications

- 1.9 to 5.2V input range
- Accurate 1.5V \pm 0.09V output voltage
- Less than 1.5 μ A quiescent current in shutdown
- Stable with a 1 μ F output capacitor
- Guaranteed 30mA output current
- Low output voltage Noise; 300 μ V_{RMS}

Features

- Operation from a low input voltage; 1.9V
- Low quiescent current; 29 μ A typical
- Stable with a ceramic capacitor
- Logic controlled shutdown
- Fast turn ON and OFF
- Thermal-overload and short circuit protection
- 5 pin package, SOT23
- -40°C to +125°C junction temperature range

Typical Application Circuit

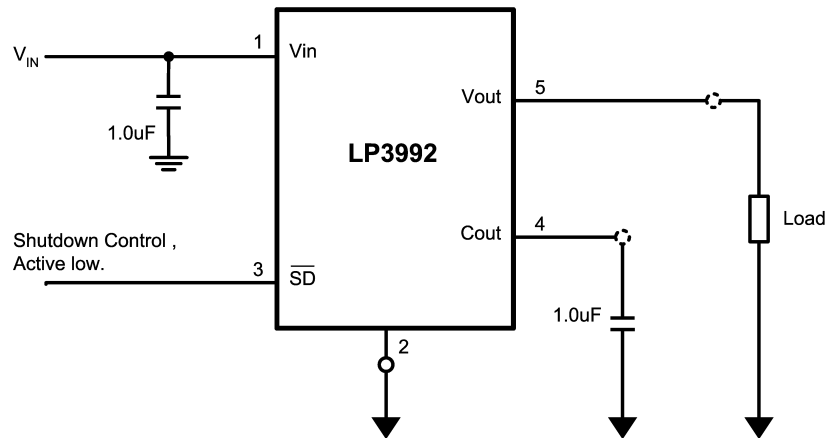

20041201

Pin Descriptions

Pin No	Symbol	Name and Function
1	V_{IN}	Voltage Supply Input
2	GND	Common Ground
3	SD	Shutdown input; Disables the regulator when $\leq 0.4V$. Enables the regulator when $\geq 1.15V$.
4	C_{OUT}	Output capacitor connection. Internally Connected to V_{OUT} connection. This is the recommended device connection for the 1.0 μF output capacitor to guarantee a stable output.
5	V_{OUT}	Voltage output. Connect this output to the load circuit.

Connection Diagram

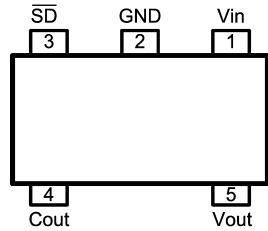

20041202

SOT23 - 5 Package (MF)
Top View
See NS package number MF05A

Ordering Information

Output Voltage (V)	Grade	LP3992 Supplied as 1000 Units, Tape and Reel	LP3992 Supplied as 3000 Units, Tape and Reel	Package Marking
1.5	STD	LP3992IMF-1.5	LP3992IMFX-1.5	
1.5	STD	LP3992IMF-1.5/E4000193	LP3992IMFX-1.5/S4000170	

Absolute Maximum Ratings

(Notes 1, 2)

If Military/Aerospace specified devices are required, please contact the National Semiconductor Sales Office/Distributors for availability and specifications.

Input Voltage	-0.3 to 6.5V
Output Voltage	-0.3 to ($V_{IN} + 0.3V$) to 6.5V (max)
Shutdown Input Voltage	-0.3 to 6.5V
Junction Temperature	150°C
Lead Temp. (Note 3)	260°C
Storage Temperature	-65 to 150°C

Thermal Resistance (Note 4)

 θ_{JA}

220°C/W

Maximum Power Dissipation at 25°C

568mW

ESD (Note 5)

Human Body Model

2KV

Machine Model

200V

Operating Conditions (Note 1)

Input Voltage	1.9 to 5.2V
Shutdown Input Voltage	0 to 6.0V
Junction Temperature	-40°C to 125°C
Power Dissipation at 25°C	454mW

Electrical Characteristics

Unless otherwise noted, $V_{SD} = 1.15V$, $V_{IN} = V_{OUT} + 1.0V$, $C_{IN} = 1\mu F$, $I_{OUT} = 1mA$, $C_{OUT} = 1\mu F$. Typical values and limits appearing in normal type apply for $T_J = 25^\circ C$. Limits appearing in **boldface** type apply over the full temperature range for operation, -40 to +125°C. (Note 13)

Symbol	Parameter	Conditions	Typ	Limit		Units
				Min	Max	
V_{IN}	Input Voltage			1.9	5.2	V
ΔV_{OUT}	Output Voltage Tolerance	Over full line and load regulation.		-90	+90	mV
	Line Regulation Error	$V_{IN} = (V_{OUT(NOM)} + 1.0V)$ to 5.2V, $I_{OUT} = 1mA$		-0.27	+0.27	%/V
	Load Regulation Error	$I_{OUT} = 1mA$ to 30mA	100		220	$\mu V/mA$
I_{LOAD}	Load Current	(Notes 6, 7)		0		μA
I_Q	Quiescent Current	$V_{SD} = 1.15V$, $I_{OUT} = 0mA$	26		50	μA
		$V_{SD} = 1.15V$, $I_{OUT} = 30mA$	29		50	
		$V_{SD} = 0.4V$	0.003		1.5	
I_{SC}	Short Circuit Current Limit	(Note 12)	90			mA
PSRR	Power Supply Rejection Ratio	$f = 1kHz$, $I_{OUT} = 30mA$	40			dB
		$f = 20kHz$, $I_{OUT} = 30mA$	30			
E_{EN}	Output noise Voltage (Note 7)	BW = 10Hz to 1000kHz, $V_{IN} = 4.2V$	300			μV_{RMS}
$T_{SHUTDOWN}$	Thermal Shutdown Temperature		160			°C
	Thermal Shutdown Hysteresis		20			

Enable Control Characteristics

I_{SD}	Maximum Input Current at SD Input	$V_{EN} = 0.0V$ and $V_{IN} = 5.2V$	0.001			μA
V_{IL}	Low Input Threshold	$V_{IN} = 1.8V$ to 5.2V			0.4	V
V_{IH}	High Input Threshold	$V_{IN} = 1.8$ to 5.2V		1.15		V

Timing Characteristics

T_{ON1}	Turn On Time (Note 7)	50 to 85% of $V_{OUT(NOM)}$ (Note 8)			15	μS
T_{ON2}		To 95% Level (Note 9)	40			
T_{OFF1}	Turn Off Time (Note 7)	85 to 50% of $V_{OUT(NOM)}$ (Note 10)			15	μS
T_{OFF2}		95 to 5% Level (Note 11)	40			
Transient Response	Line Transient Response $ \delta V_{OUT} $	$T_{rise} = T_{fall} = 10\mu S$ (Note 7)			60	mV
	Load Transient Response $ \delta V_{OUT} $	$T_{rise} = T_{fall} = 1\mu S$ $I_{OUT} = 100\mu A$ to 5mA (Note 7)			60	

Note 1: Absolute Maximum Ratings are limits beyond which damage can occur. Operating Ratings are conditions under which operation of the device is guaranteed. Operating Ratings do not imply guaranteed performance limits. For guaranteed performance limits and associated test conditions, see the Electrical Characteristics tables.

Note 2: All Voltages are with respect to the potential at the GND pin.

Electrical Characteristics (Continued)

Note 3: The package can pass MSL (moisture sensitivity level) 1 at 260°C.

Additional information on lead temperature can be obtained from National Semiconductor web pages

<http://www.national.com/packaging/general.html>

<http://www.national.com/packaging/plastic.html>

Note 4: The Maximum power dissipation of the device is dependant on the maximum allowable junction temperature for the device and the ambient temperature. This relationship is given by the formula

$$P_D = (T_J - T_A) / \theta_{JA}$$

Where T_J is the junction temperature, T_A is the ambient temperature, and θ_{JA} is the junction-to-ambient thermal resistance. The Maximum Power dissipation across the device related to the operational conditions can be calculated using the formula

$$P_D = (V_{IN(MAX)} - V_{OUT(MAX)}) * (I_{OUT(MAX)})$$

Substituting the device values gives the max power dissipation = $(5.2V - 1.5V)(0.03) = 0.111W$. This figure for Maximum power dissipation can be used to derive the maximum ambient temperature. For the SOT23-5 package $\theta_{JA} = 220^\circ C/W$, thus for this device the maximum temperature difference, $(T_J - T_A)$, is $24.4^\circ C$, $(0.111 * 220)$. This gives the maximum ambient temperature for operation as $100.6^\circ C$, $(125 - 24.4)$. Similarly the numbers for the absolute maximum case can be derived using a figure of $150^\circ C$ for the junction temperature.

Note 5: The human body is 100pF discharge through 1.5kW resistor into each pin. The machine model is a 200 pF capacitor discharged directly into each pin.

Note 6: The device maintains the regulated output voltage without the load.

Note 7: This electrical specification is guaranteed by design.

Note 8: Time for V_{OUT} to rise from 50 to 85% of $V_{OUT(nom)}$. (figure 1)

Note 9: Time from $V_{SD} = 1.15V$ to $V_{OUT} = 95\%(V_{OUT(nom)})$. (figure 1)

Note 10: Time for V_{OUT} to fall from 85 to 50% of $V_{OUT(nom)}$. (figure 1)

Note 11: Time from $V_{SD} = 0.4V$ to $V_{OUT} = 5\%(V_{OUT(nom)})$. (figure 1)

Note 12: Short circuit current is measured on the input supply line at the point when the short circuit condition reduces the output voltage to 95% of its nominal value.

Note 13: All limits are guaranteed. All electrical characteristics having room-temperature limits are tested during production at $T_J = 25^\circ C$ or correlated using Statistical Quality Control methods. Operation over the temperature specification is guaranteed by correlating the electrical characteristics to process and temperature variations and applying statistical process control.

Output Capacitor, Recommended Specifications

Symbol	Parameter	Conditions	Typ	Limit		Units
				Min	Max	
C _o	Output Capacitor	Capacitance(Note 14)		1.0		μF
		ESR		5	500	mΩ

Note 14: Capacitor types recommended are X7R, Y5V, and Z5U. X7R tolerance is quoted as 15% over temperature.

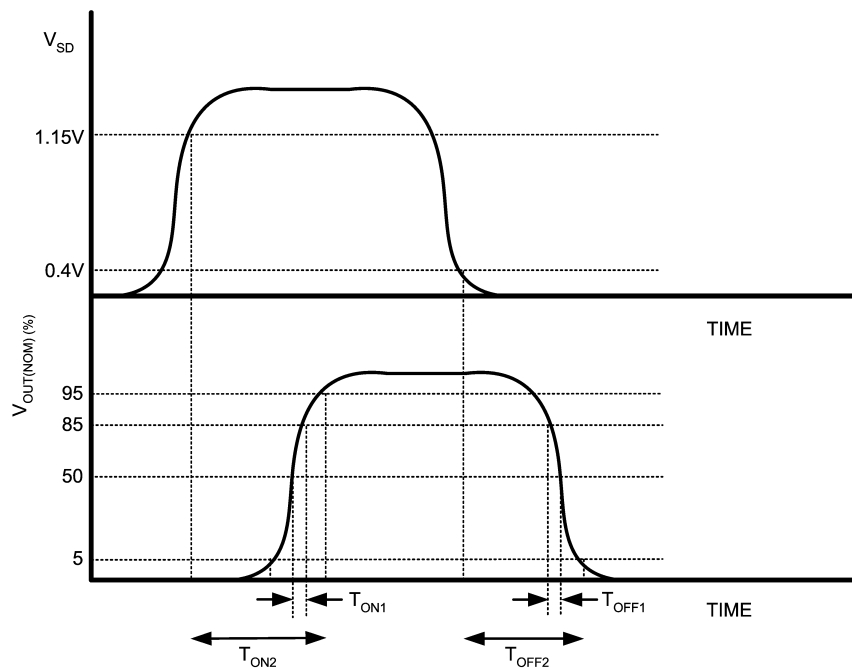

20041203

FIGURE 1. Figure 1. T_{on}/T_{off} Timing Diagram

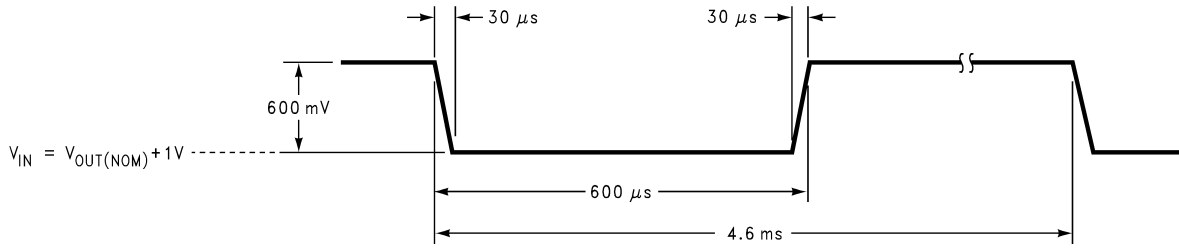

FIGURE 2. Figure 2. Line Transient Input Test Signal.

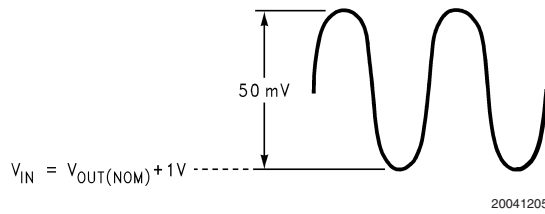
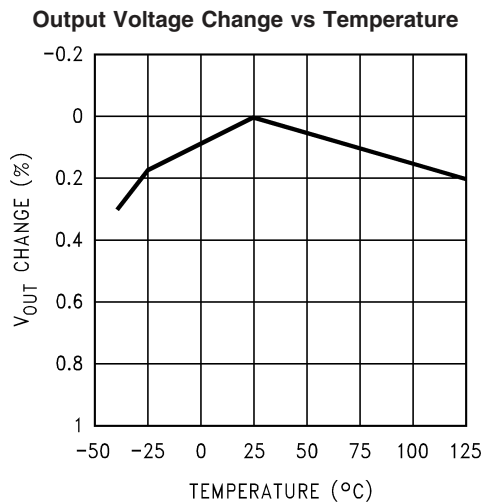
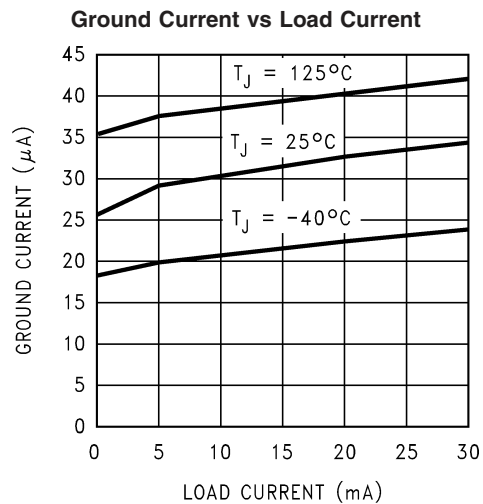

FIGURE 3. Figure 3. PSRR Input Test Signal.

Typical Performance Characteristics. Unless otherwise specified, $C_{IN} = C_{OUT} = 1.0 \mu F$ Ceramic, $V_{IN} = 2.8V$, $T_A = 25^\circ C$, Shutdown pin is tied to V_{IN} .



20041207



20041208

Typical Performance Characteristics. Unless otherwise specified, $C_{IN} = C_{OUT} = 1.0 \mu\text{F}$ Ceramic, $V_{IN} = 2.8\text{V}$, $T_A = 25^\circ\text{C}$, Shutdown pin is tied to V_{IN} . (Continued)

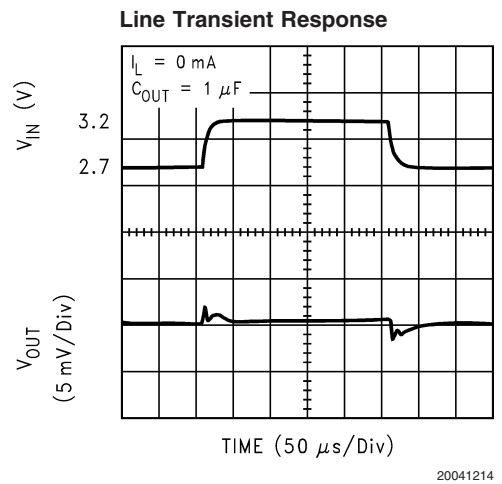
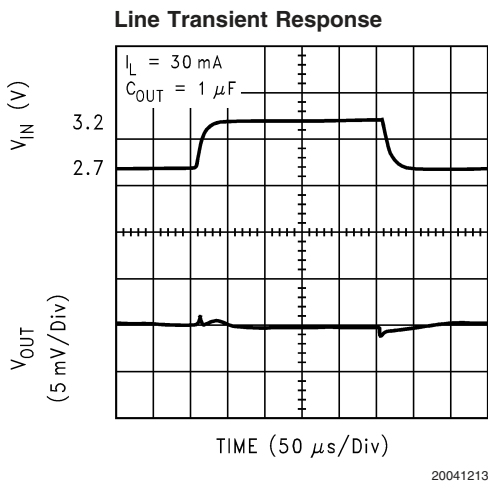
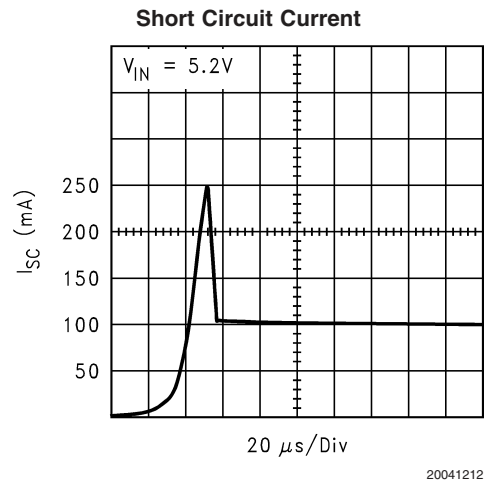
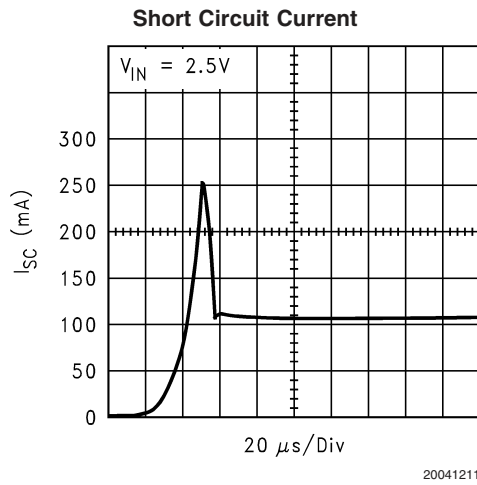
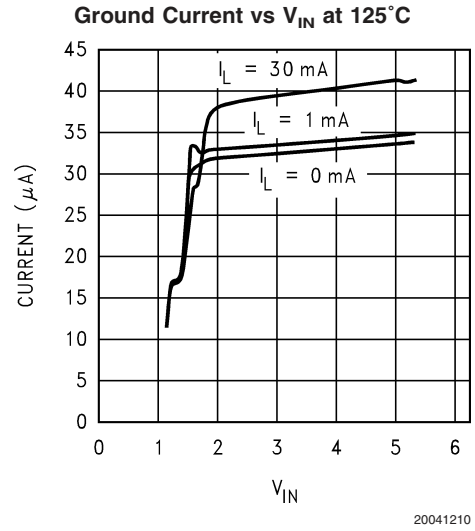
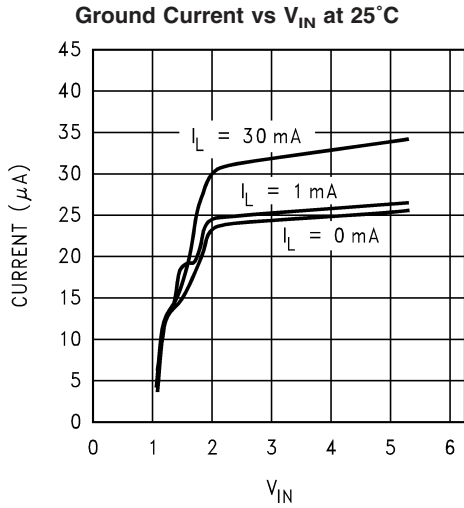

Typical Performance Characteristics. Unless otherwise specified, $C_{IN} = C_{OUT} = 1.0 \mu F$ Ceramic, $V_{IN} = 2.8V$, $T_A = 25^\circ C$, Shutdown pin is tied to V_{IN} . (Continued)

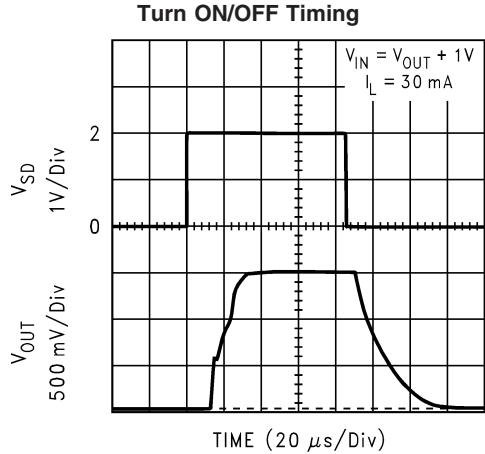

20041215

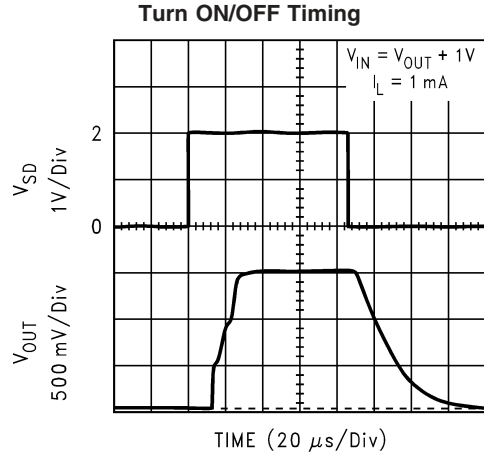

20041216

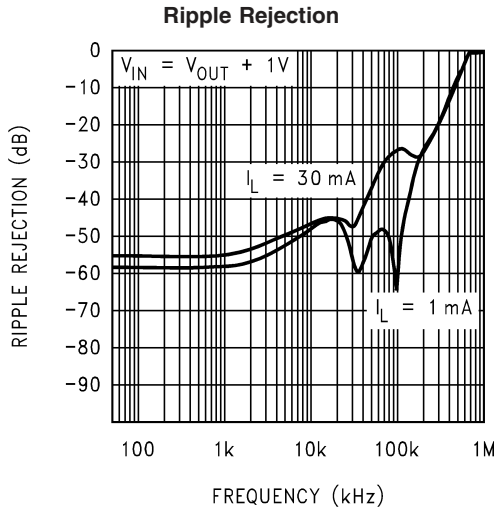

20041217

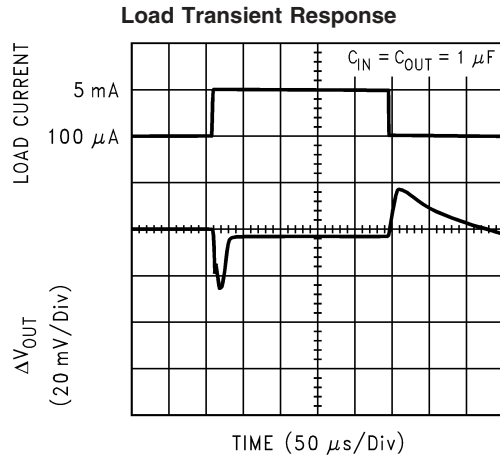

20041218

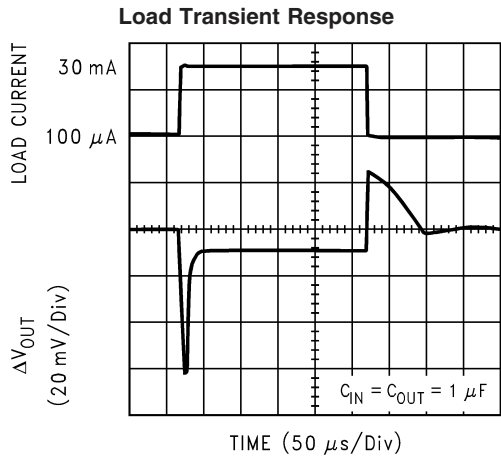

20041219

Application Hints

EXTERNAL CAPACITORS

In common with most regulators, the LP3992 requires external capacitors for regulator stability. The LP3992 is specifically designed for portable applications requiring minimum board space and smallest components. These capacitors must be correctly selected for good performance.

INPUT CAPACITOR

An input capacitor is required for stability. It is recommended that a 1.0 μ F capacitor be connected between the LP3992 input pin and ground (this capacitance value may be increased without limit).

This capacitor must be located a distance of not more than 1cm from the input pin and returned to a clean analogue ground. Any good quality ceramic, tantalum, or film capacitor may be used at the input.

Important: Tantalum capacitors can suffer catastrophic failures due to surge current when connected to a low-impedance source of power (like a battery or a very large capacitor). If a tantalum capacitor is used at the input, it must be guaranteed by the manufacturer to have a surge current rating sufficient for the application.

There are no requirements for the ESR (Equivalent Series Resistance) on the input capacitor, but tolerance and temperature coefficient must be considered when selecting the capacitor to ensure the capacitance will remain \approx 1.0 μ F over the entire operating temperature range.

OUTPUT CAPACITOR

The LP3992 is designed specifically to work with very small ceramic output capacitors. A 1.0 μ F ceramic capacitor (dielectric types Z5U, Y5V or X7R) with ESR between 5m Ω to 500m Ω , is suitable in the LP3992 application circuit.

For this device the output capacitor should be connected between the C_{OUT} pin and ground. It is also possible to connect the output capacitor directly to the V_{OUT} pin. In this case C_{OUT} should be left open-circuit or tied directly to V_{OUT}. It may also be possible to use tantalum or film capacitors at the device output, C_{OUT} (or V_{OUT}), but these are not as attractive for reasons of size and cost (see the section Capacitor Characteristics).

The output capacitor must meet the requirement for the minimum value of capacitance and also have an ESR value that is within the range 5m Ω to 500m Ω for stability.

NO-LOAD STABILITY

The LP3992 will remain stable and in regulation with no external load. This is an important consideration in some circuits, for example CMOS RAM keep-alive applications.

CAPACITOR CHARACTERISTICS

The LP3992 is designed to work with ceramic capacitors on the output to take advantage of the benefits they offer. For capacitance values in the range of 1 μ F to 4.7 μ F, ceramic

capacitors are the smallest, least expensive and have the lowest ESR values, thus making them best for eliminating high frequency noise. The ESR of a typical 1 μ F ceramic capacitor is in the range of 20m Ω to 40m Ω , which easily meets the ESR requirement for stability for the LP3992.

The temperature performance of ceramic capacitors varies by type. Most large value ceramic capacitors (\geq 2.2 μ F) are manufactured with Z5U or Y5V temperature characteristics, which results in the capacitance dropping by more than 50% as the temperature goes from 25°C to 85°C.

A better choice for temperature coefficient in a ceramic capacitor is X7R. This type of capacitor is the most stable and holds the capacitance within \pm 15% over the temperature range.

Tantalum capacitors are less desirable than ceramic for use as output capacitors because they are more expensive when comparing equivalent capacitance and voltage ratings in the 1 μ F to 4.7 μ F range.

Another important consideration is that tantalum capacitors have higher ESR values than equivalent size ceramics. This means that while it may be possible to find a tantalum capacitor with an ESR value within the stable range, it would have to be larger in capacitance (which means bigger and more costly) than a ceramic capacitor with the same ESR value. It should also be noted that the ESR of a typical tantalum will increase about 2:1 as the temperature goes from 25°C down to -40°C, so some guard band must be allowed.

SHUTDOWN AND ENABLE

The LP3992 features an active low shutdown pin, V_{SD}, which turns the device off when pulled low. The device output is enabled when the shutdown pin is pulled high. In the shutdown mode the regulator output is off and the device typically consumes 3nA.

If the application does not require the shutdown feature, the V_{SD} pin should be tied to V_{IN} to keep the regulator output permanently on.

To ensure proper operation, the signal source used to drive the V_{SD} input must be able to swing above and below the specified turn-on/off voltage thresholds listed in the Electrical Characteristics section under V_{IL} and V_{IH}.

FAST TURN ON AND OFF

The controlled shutdown feature of the device provides a fast turn off by discharging the output capacitor via an internal FET device. This discharge is current limited by the RDS_{ON} of this switch. Fast turn-on is guaranteed by control circuitry within the reference block allowing a very fast ramp of the output voltage to reach the target voltage.

Physical Dimensions inches (millimeters)

unless otherwise noted

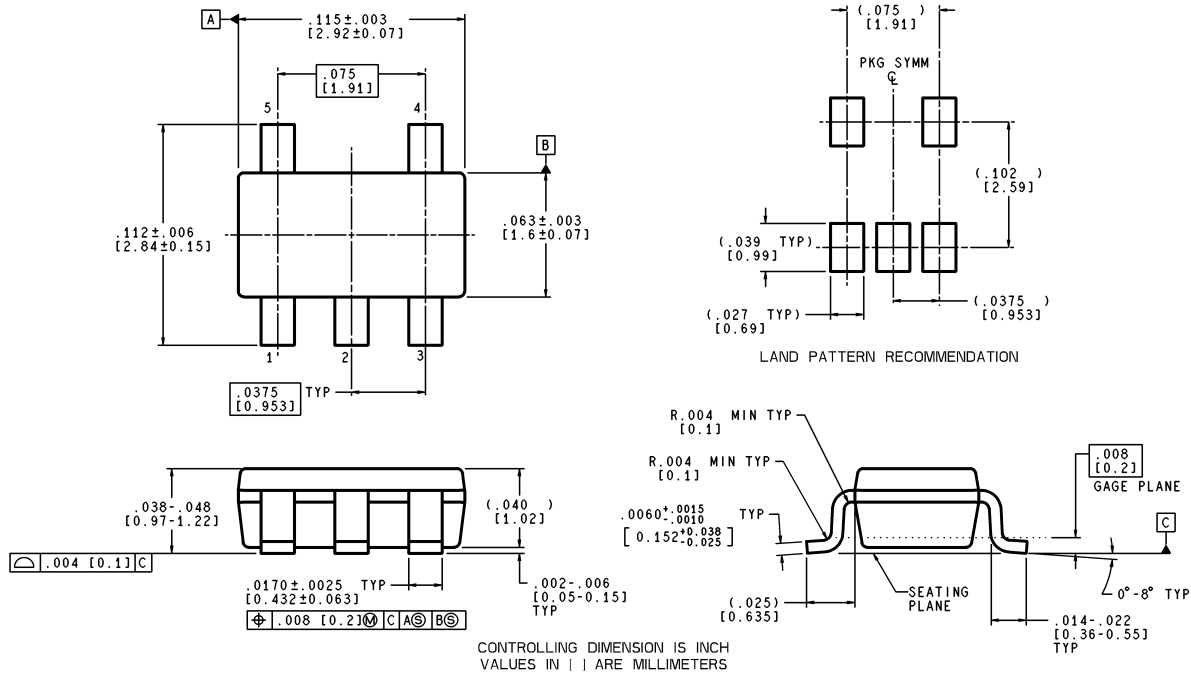

MF05A (Rev A)

LIFE SUPPORT POLICY

NATIONAL'S PRODUCTS ARE NOT AUTHORIZED FOR USE AS CRITICAL COMPONENTS IN LIFE SUPPORT DEVICES OR SYSTEMS WITHOUT THE EXPRESS WRITTEN APPROVAL OF THE PRESIDENT AND GENERAL COUNSEL OF NATIONAL SEMICONDUCTOR CORPORATION. As used herein:

1. Life support devices or systems are devices or systems which, (a) are intended for surgical implant into the body, or (b) support or sustain life, and whose failure to perform when properly used in accordance with instructions for use provided in the labeling, can be reasonably expected to result in a significant injury to the user.
2. A critical component is any component of a life support device or system whose failure to perform can be reasonably expected to cause the failure of the life support device or system, or to affect its safety or effectiveness.



National Semiconductor Corporation
Americas
Email: support@nsc.com

National Semiconductor Europe
Fax: +49 (0) 180-530 85 86
Email: europe.support@nsc.com
Deutsch Tel: +49 (0) 69 9508 6208
English Tel: +44 (0) 870 24 0 2171
Français Tel: +33 (0) 1 41 91 8790

National Semiconductor Asia Pacific Customer Response Group
Tel: 65-2544466
Fax: 65-2504466
Email: ap.support@nsc.com

National Semiconductor Japan Ltd.
Tel: 81-3-5639-7560
Fax: 81-3-5639-7507

www.national.com