

# JFET VHF/UHF Amplifiers

## N-Channel — Depletion

**J308**  
**J309**  
**J310**

ON Semiconductor Preferred Devices

### MAXIMUM RATINGS

Rating	Symbol	Value	Unit
Drain–Source Voltage	$V_{DS}$	25	Vdc
Gate–Source Voltage	$V_{GS}$	25	Vdc
Forward Gate Current	$I_{GF}$	10	mAdc
Total Device Dissipation @ $T_A = 25^\circ\text{C}$ Derate above $25^\circ\text{C}$	$P_D$	350 2.8	mW mW/°C
Junction Temperature Range	$T_J$	-65 to +125	°C
Storage Temperature Range	$T_{stg}$	-65 to +150	°C

**CASE 29–11, STYLE 5**  
**TO–92 (TO–226AA)**

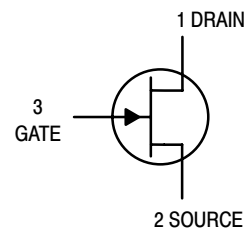

### ELECTRICAL CHARACTERISTICS ( $T_A = 25^\circ\text{C}$ unless otherwise noted)

Characteristic	Symbol	Min	Typ	Max	Unit
----------------	--------	-----	-----	-----	------

#### OFF CHARACTERISTICS

Gate–Source Breakdown Voltage ( $I_G = -1.0 \mu\text{Adc}$ , $V_{DS} = 0$ )	$V_{(BR)GSS}$	-25	—	—	Vdc
Gate Reverse Current ( $V_{GS} = -15 \text{ Vdc}$ , $V_{DS} = 0$ , $T_A = 25^\circ\text{C}$ ) ( $V_{GS} = -15 \text{ Vdc}$ , $V_{DS} = 0$ , $T_A = +125^\circ\text{C}$ )	$I_{GSS}$	— —	— —	-1.0 -1.0	nAdc $\mu\text{Adc}$
Gate Source Cutoff Voltage ( $V_{DS} = 10 \text{ Vdc}$ , $I_D = 1.0 \text{ nAdc}$ )	$V_{GS(off)}$	-1.0 -1.0 -2.0	— — —	-6.5 -4.0 -6.5	Vdc

#### ON CHARACTERISTICS

Zero–Gate–Voltage Drain Current <sup>(1)</sup> ( $V_{DS} = 10 \text{ Vdc}$ , $V_{GS} = 0$ )	$I_{DSS}$	12 12 24	— — —	60 30 60	mAdc
Gate–Source Forward Voltage ( $V_{DS} = 0$ , $I_G = 1.0 \text{ mAdc}$ )	$V_{GS(f)}$	—	—	1.0	Vdc

# J308 J309 J310

Characteristic	Symbol	Min	Typ	Max	Unit	
<b>SMALL-SIGNAL CHARACTERISTICS</b>						
Common-Source Input Conductance ( $V_{DS} = 10 \text{ Vdc}$ , $I_D = 10 \text{ mAdc}$ , $f = 100 \text{ MHz}$ )	J308 J309 J310	$Re(y_{is})$	— — —	0.7 0.7 0.5	— — —	mmhos
Common-Source Output Conductance ( $V_{DS} = 10 \text{ Vdc}$ , $I_D = 10 \text{ mAdc}$ , $f = 100 \text{ MHz}$ )		$Re(y_{os})$	—	0.25	—	mmhos
Common-Gate Power Gain ( $V_{DS} = 10 \text{ Vdc}$ , $I_D = 10 \text{ mAdc}$ , $f = 100 \text{ MHz}$ )		$G_{pg}$	—	16	—	dB

1. Pulse Test: Pulse Width  $\leq 300 \mu\text{s}$ , Duty Cycle  $\leq 3.0\%$ .

## SMALL-SIGNAL CHARACTERISTICS (continued)

Common-Source Forward Transconductance ( $V_{DS} = 10 \text{ Vdc}$ , $I_D = 10 \text{ mAdc}$ , $f = 100 \text{ MHz}$ )		$Re(y_{fs})$	—	12	—	mmhos
Common-Gate Input Conductance ( $V_{DS} = 10 \text{ Vdc}$ , $I_D = 10 \text{ mAdc}$ , $f = 100 \text{ MHz}$ )		$Re(y_{ig})$	—	12	—	mmhos
Common-Source Forward Transconductance ( $V_{DS} = 10 \text{ Vdc}$ , $I_D = 10 \text{ mAdc}$ , $f = 1.0 \text{ kHz}$ )	J308 J309 J310	$g_{fs}$	8000 10000 8000	— — —	20000 20000 18000	$\mu\text{mhos}$
Common-Source Output Conductance ( $V_{DS} = 10 \text{ Vdc}$ , $I_D = 10 \text{ mAdc}$ , $f = 1.0 \text{ kHz}$ )		$g_{os}$	—	—	250	$\mu\text{mhos}$
Common-Gate Forward Transconductance ( $V_{DS} = 10 \text{ Vdc}$ , $I_D = 10 \text{ mAdc}$ , $f = 1.0 \text{ kHz}$ )	J308 J309 J310	$g_{fg}$	— — —	13000 13000 12000	— — —	$\mu\text{mhos}$
Common-Gate Output Conductance ( $V_{DS} = 10 \text{ Vdc}$ , $I_D = 10 \text{ mAdc}$ , $f = 1.0 \text{ kHz}$ )	J308 J309 J310	$g_{og}$	— — —	150 100 150	— — —	$\mu\text{mhos}$
Gate-Drain Capacitance ( $V_{DS} = 0$ , $V_{GS} = -10 \text{ Vdc}$ , $f = 1.0 \text{ MHz}$ )		$C_{gd}$	—	1.8	2.5	pF
Gate-Source Capacitance ( $V_{DS} = 0$ , $V_{GS} = -10 \text{ Vdc}$ , $f = 1.0 \text{ MHz}$ )		$C_{gs}$	—	4.3	5.0	pF

## FUNCTIONAL CHARACTERISTICS

Noise Figure ( $V_{DS} = 10 \text{ Vdc}$ , $I_D = 10 \text{ mAdc}$ , $f = 450 \text{ MHz}$ )	NF	—	1.5	—	dB
Equivalent Short-Circuit Input Noise Voltage ( $V_{DS} = 10 \text{ Vdc}$ , $I_D = 10 \text{ mAdc}$ , $f = 100 \text{ Hz}$ )	$\bar{e}_n$	—	10	—	$\text{nV}/\sqrt{\text{Hz}}$

# J308 J309 J310

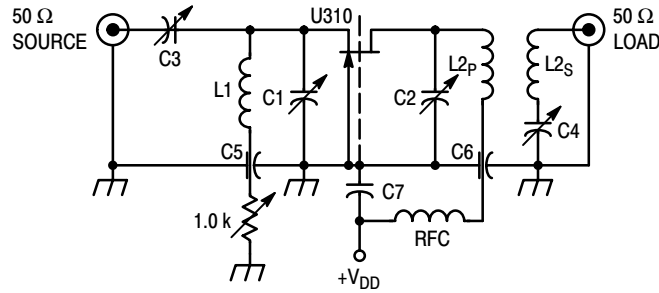

C1 = C2 = 0.8 – 10 pF, JFD #MVM010W.  
 C3 = C4 = 8.35 pF Erie #539-002D.  
 C5 = C6 = 5000 pF Erie (2443-000).  
 C7 = 1000 pF, Allen Bradley #FA5C.  
 RFC = 0.33 μH Miller #9230-30.  
 L1 = One Turn #16 Cu, 1/4" I.D. (Air Core).  
 L2P = One Turn #16 Cu, 1/4" I.D. (Air Core).  
 L2S = One Turn #16 Cu, 1/4" I.D. (Air Core).

**Figure 1. 450 MHz Common-Gate Amplifier Test Circuit**

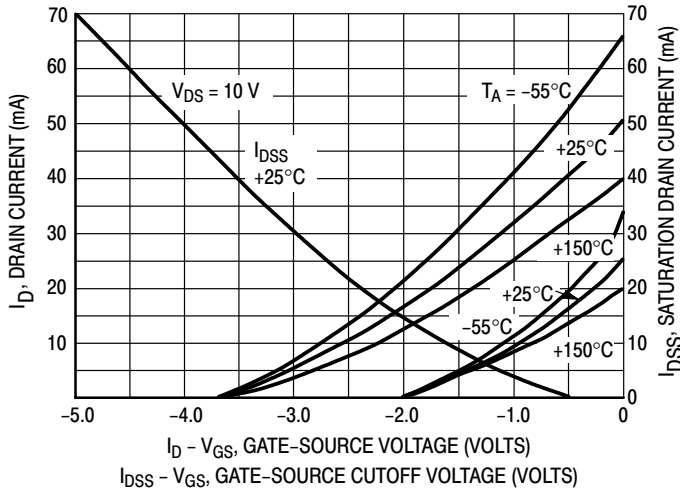

**Figure 2. Drain Current and Transfer Characteristics versus Gate-Source Voltage**

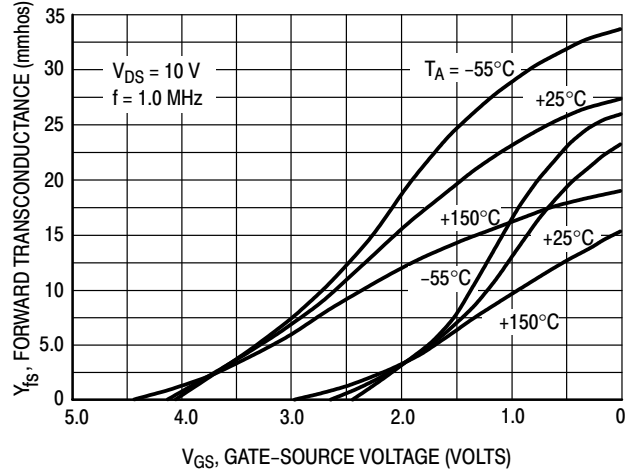

**Figure 3. Forward Transconductance versus Gate-Source Voltage**

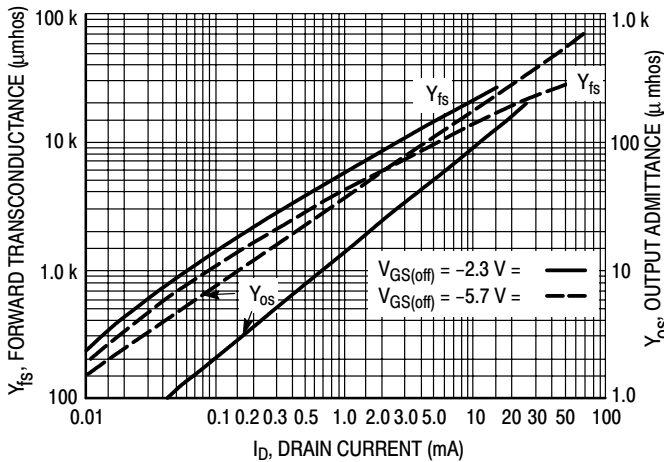

**Figure 4. Common-Source Output Admittance and Forward Transconductance versus Drain Current**

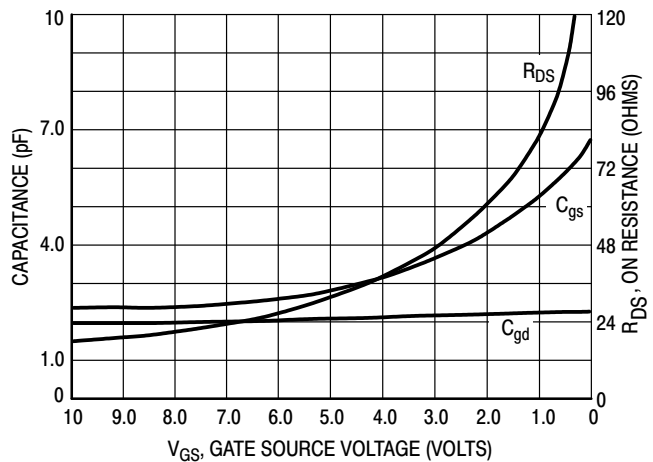

**Figure 5. On Resistance and Junction Capacitance versus Gate-Source Voltage**

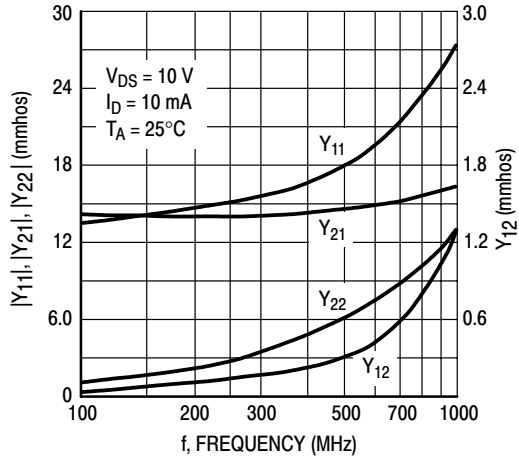

Figure 6. Common-Gate Y Parameter Magnitude versus Frequency

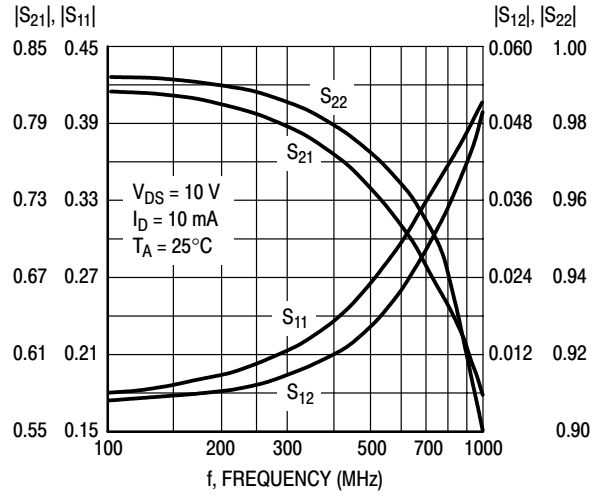

Figure 7. Common-Gate S Parameter Magnitude versus Frequency

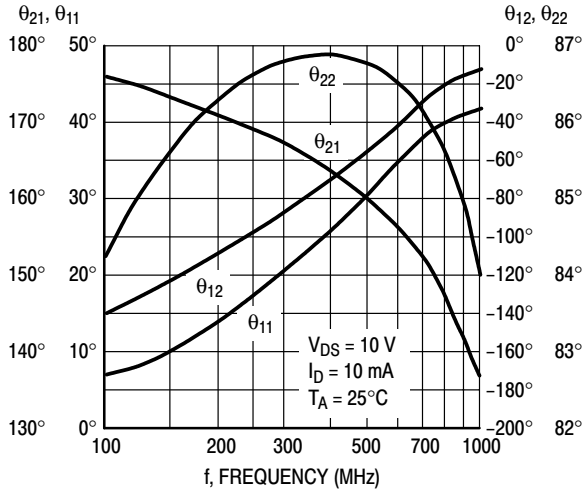

Figure 8. Common-Gate Y Parameter Phase-Angle versus Frequency

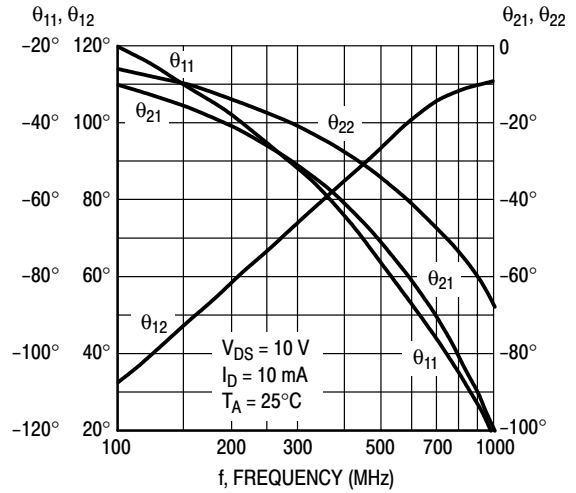

Figure 9. S Parameter Phase-Angle versus Frequency

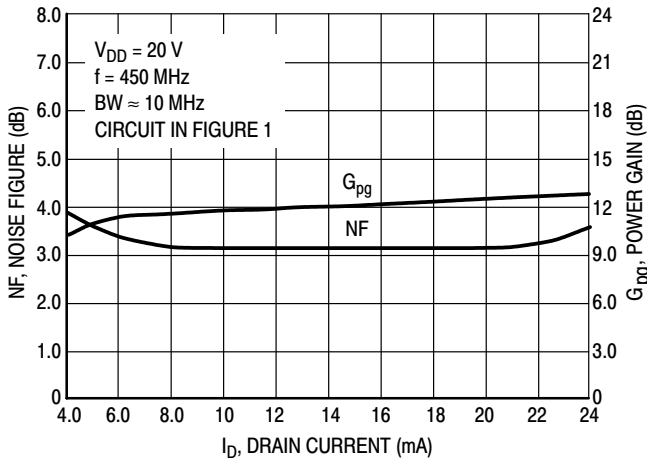

Figure 10. Noise Figure and Power Gain versus Drain Current

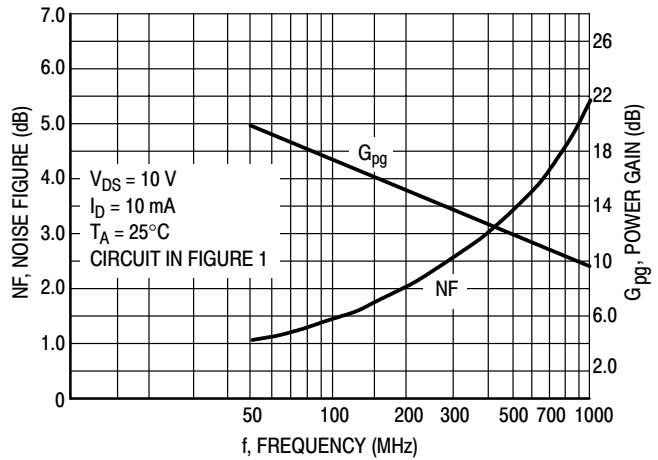
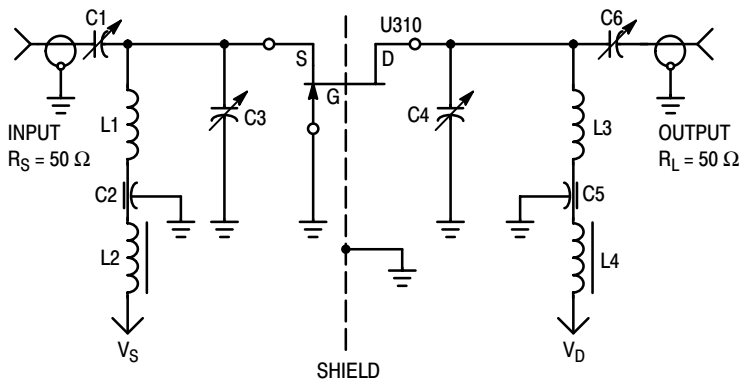

Figure 11. Noise Figure and Power Gain versus Frequency

## J308 J309 J310



$B_W$  (3 dB) – 36.5 MHz  
 $I_D$  – 10 mAdc  
 $V_{DS}$  – 20 Vdc  
 Device case grounded  
 IM test tones –  $f_1 = 449.5$  MHz,  $f_2 = 450.5$  MHz  
 $C_1 = 1$ –10 pF Johanson Air variable trimmer.  
 $C_2, C_5 = 100$  pF feed thru button capacitor.  
 $C_3, C_4, C_6 = 0.5$ –6 pF Johanson Air variable trimmer.  
 $L_1 = 1/8'' \times 1/32'' \times 1$ –5/8'' copper bar.  
 $L_2, L_4 =$  Ferroxcube Vk200 choke.  
 $L_3 = 1/8'' \times 1/32'' \times 1$ –7/8'' copper bar.

Figure 12. 450 MHz IMD Evaluation Amplifier

Amplifier power gain and IMD products are a function of the load impedance. For the amplifier design shown above with  $C_4$  and  $C_6$  adjusted to reflect a load to the drain resulting in a nominal power gain of 9 dB, the 3rd order intercept point (IP) value is 29 dBm. Adjusting  $C_4, C_6$  to provide larger load values will result in higher gain, smaller bandwidth and lower IP values. For example, a nominal gain of 13 dB can be achieved with an intercept point of 19 dBm.

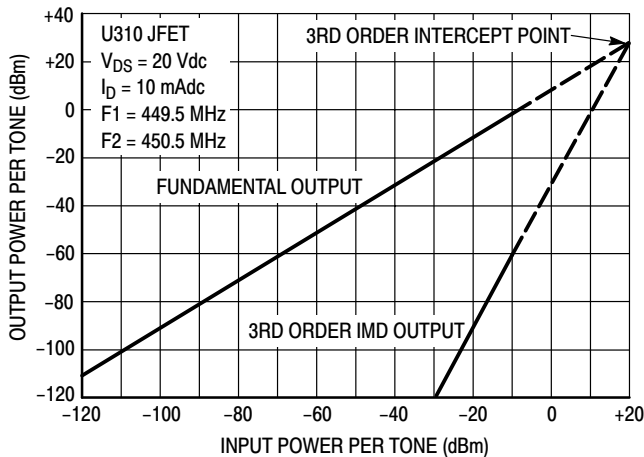

Example of intercept point plot use:

Assume two in-band signals of  $-20$  dBm at the amplifier input. They will result in a 3rd order IMD signal at the output of  $-90$  dBm. Also, each signal level at the output will be  $-11$  dBm, showing an amplifier gain of 9.0 dB and an intermodulation ratio (IMR) capability of 79 dB. The gain and IMR values apply only for signal levels below comparison.

Figure 13. Two Tone 3rd Order Intercept Point

# J308 J309 J310

## PACKAGE DIMENSIONS

TO-92 (TO-226AA)  
CASE 29-11  
ISSUE AL

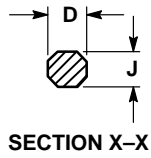
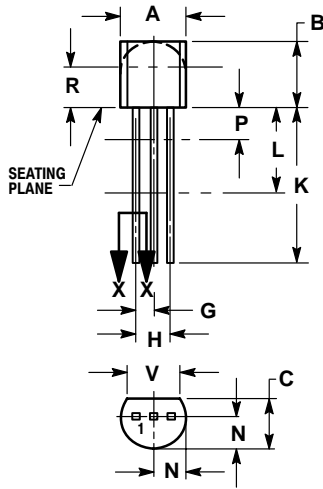

STYLE 5:  
PIN 1. DRAIN  
2. SOURCE  
3. GATE

NOTES:

1. DIMENSIONING AND TOLERANCING PER ANSI Y14.5M, 1982.
2. CONTROLLING DIMENSION: INCH.
3. CONTOUR OF PACKAGE BEYOND DIMENSION R IS UNCONTROLLED.
4. LEAD DIMENSION IS UNCONTROLLED IN P AND BEYOND DIMENSION K MINIMUM.

DIM	INCHES		MILLIMETERS	
	MIN	MAX	MIN	MAX
A	0.175	0.205	4.45	5.20
B	0.170	0.210	4.32	5.33
C	0.125	0.165	3.18	4.19
D	0.016	0.021	0.407	0.533
G	0.045	0.055	1.15	1.39
H	0.095	0.105	2.42	2.66
J	0.015	0.020	0.39	0.50
K	0.500	---	12.70	---
L	0.250	---	6.35	---
N	0.080	0.105	2.04	2.66
P	---	0.100	---	2.54
R	0.115	---	2.93	---
V	0.135	---	3.43	---

## Notes

**ON Semiconductor** and  are trademarks of Semiconductor Components Industries, LLC (SCILLC). SCILLC reserves the right to make changes without further notice to any products herein. SCILLC makes no warranty, representation or guarantee regarding the suitability of its products for any particular purpose, nor does SCILLC assume any liability arising out of the application or use of any product or circuit, and specifically disclaims any and all liability, including without limitation special, consequential or incidental damages. "Typical" parameters which may be provided in SCILLC data sheets and/or specifications can and do vary in different applications and actual performance may vary over time. All operating parameters, including "Typicals" must be validated for each customer application by customer's technical experts. SCILLC does not convey any license under its patent rights nor the rights of others. SCILLC products are not designed, intended, or authorized for use as components in systems intended for surgical implant into the body, or other applications intended to support or sustain life, or for any other application in which the failure of the SCILLC product could create a situation where personal injury or death may occur. Should Buyer purchase or use SCILLC products for any such unintended or unauthorized application, Buyer shall indemnify and hold SCILLC and its officers, employees, subsidiaries, affiliates, and distributors harmless against all claims, costs, damages, and expenses, and reasonable attorney fees arising out of, directly or indirectly, any claim of personal injury or death associated with such unintended or unauthorized use, even if such claim alleges that SCILLC was negligent regarding the design or manufacture of the part. SCILLC is an Equal Opportunity/Affirmative Action Employer.

## PUBLICATION ORDERING INFORMATION

### **NORTH AMERICA Literature Fulfillment:**

Literature Distribution Center for ON Semiconductor  
P.O. Box 5163, Denver, Colorado 80217 USA  
**Phone:** 303-675-2175 or 800-344-3860 Toll Free USA/Canada  
**Fax:** 303-675-2176 or 800-344-3867 Toll Free USA/Canada  
**Email:** ONlit@hibbertco.com  
Fax Response Line: 303-675-2167 or 800-344-3810 Toll Free USA/Canada

**N. American Technical Support:** 800-282-9855 Toll Free USA/Canada

**EUROPE:** LDC for ON Semiconductor – European Support

**German Phone:** (+1) 303-308-7140 (Mon-Fri 2:30pm to 7:00pm CET)  
**Email:** ONlit-german@hibbertco.com  
**French Phone:** (+1) 303-308-7141 (Mon-Fri 2:00pm to 7:00pm CET)  
**Email:** ONlit-french@hibbertco.com  
**English Phone:** (+1) 303-308-7142 (Mon-Fri 12:00pm to 5:00pm GMT)  
**Email:** ONlit@hibbertco.com

**EUROPEAN TOLL-FREE ACCESS\*: 00-800-4422-3781**

\*Available from Germany, France, Italy, UK, Ireland

### **CENTRAL/SOUTH AMERICA:**

**Spanish Phone:** 303-308-7143 (Mon-Fri 8:00am to 5:00pm MST)  
**Email:** ONlit-spanish@hibbertco.com  
**Toll-Free from Mexico:** Dial 01-800-288-2872 for Access –  
then Dial 866-297-9322

**ASIA/PACIFIC:** LDC for ON Semiconductor – Asia Support

**Phone:** 1-303-675-2121 (Tue-Fri 9:00am to 1:00pm, Hong Kong Time)  
**Toll Free from Hong Kong & Singapore:**  
**001-800-4422-3781**  
**Email:** ONlit-asia@hibbertco.com

**JAPAN:** ON Semiconductor, Japan Customer Focus Center

4-32-1 Nishi-Gotanda, Shinagawa-ku, Tokyo, Japan 141-0031  
**Phone:** 81-3-5740-2700  
**Email:** r14525@onsemi.com

**ON Semiconductor Website:** <http://onsemi.com>

For additional information, please contact your local Sales Representative.