

MMBTA42LT1, MMBTA43LT1

MMBTA42LT1 is a Preferred Device

High Voltage Transistors NPN Silicon

Features

- Pb-Free Package May be Available. The G-Suffix Denotes a Pb-Free Lead Finish

MAXIMUM RATINGS

Rating	Symbol	MMBTA42	MMBTA43	Unit
Collector-Emitter Voltage	V_{CEO}	300	200	Vdc
Collector-Base Voltage	V_{CBO}	300	200	Vdc
Emitter-Base Voltage	V_{EBO}	6.0	6.0	Vdc
Collector Current-Continuous	I_C	500		mAdc

THERMAL CHARACTERISTICS

Characteristic	Symbol	Max	Unit
Total Device Dissipation FR-5 Board (Note 1) $T_A = 25^\circ\text{C}$ Derate above 25°C	P_D	225	mW
		1.8	mW/ $^\circ\text{C}$
Thermal Resistance, Junction-to-Ambient	$R_{\theta JA}$	556	$^\circ\text{C}/\text{W}$
Total Device Dissipation Alumina Substrate (Note 2) $T_A = 25^\circ\text{C}$ Derate above 25°C	P_D	300	mW
		2.4	mW/ $^\circ\text{C}$
Thermal Resistance, Junction-to-Ambient	$R_{\theta JA}$	417	$^\circ\text{C}/\text{W}$
Junction and Storage Temperature	T_J, T_{stg}	-55 to +150	$^\circ\text{C}$

1. FR-5 = 1.0 x 0.75 x 0.062 in.

2. Alumina = 0.4 x 0.3 x 0.024 in. 99.5% alumina.



ON Semiconductor®

<http://onsemi.com>

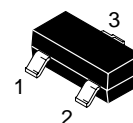
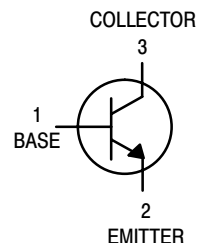

SOT-23 (TO-236)
CASE 318
STYLE 6

MARKING DIAGRAMS

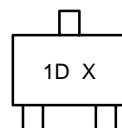

MMBTA42LT1

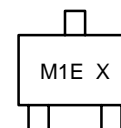

MMBTA43LT1

1D, M1E = Specific Device Code
X = Date Code

ORDERING INFORMATION

Device	Package	Shipping†
MMBTA42LT1	SOT-23	3000/Tape & Reel
MMBTA42LT1G	SOT-23	3000/Tape & Reel
MMBTA43LT1	SOT-23	3000/Tape & Reel
MMBTA43LT3	SOT-23	10000/Tape & Reel

†For information on tape and reel specifications, including part orientation and tape sizes, please refer to our Tape and Reel Packaging Specifications Brochure, BRD8011/D.

Preferred devices are recommended choices for future use and best overall value.

MMBTA42LT1, MMBTA43LT1

ELECTRICAL CHARACTERISTICS (T_A = 25°C unless otherwise noted)

Characteristic		Symbol	Min	Max	Unit
OFF CHARACTERISTICS					
Collector–Emitter Breakdown Voltage (Note 3) (I _C = 1.0 mA, I _B = 0)	MMBTA42 MMBTA43	V _{(BR)CEO}	300 200	– –	Vdc
Collector–Base Breakdown Voltage (I _C = 100 μA, I _E = 0)	MMBTA42 MMBTA43	V _{(BR)CBO}	300 200	– –	Vdc
Emitter–Base Breakdown Voltage (I _E = 100 μA, I _C = 0)		V _{(BR)EBO}	6.0	–	Vdc
Collector Cutoff Current (V _{CB} = 200 Vdc, I _E = 0) (V _{CB} = 160 Vdc, I _E = 0)	MMBTA42 MMBTA43	I _{CBO}	– –	0.1 0.1	μA
Emitter Cutoff Current (V _{EB} = 6.0 Vdc, I _C = 0) (V _{EB} = 4.0 Vdc, I _C = 0)	MMBTA42 MMBTA43	I _{EBO}	– –	0.1 0.1	μA
ON CHARACTERISTICS (Note 3)					
DC Current Gain (I _C = 1.0 mA, V _{CE} = 10 Vdc) (I _C = 10 mA, V _{CE} = 10 Vdc) (I _C = 30 mA, V _{CE} = 10 Vdc)	Both Types Both Types MMBTA42 MMBTA43	h _{FE}	25 40 40 40	– – – –	–
Collector–Emitter Saturation Voltage (I _C = 20 mA, I _B = 2.0 mA)	MMBTA42 MMBTA43	V _{CE(sat)}	– –	0.5 0.5	Vdc
Base–Emitter Saturation Voltage (I _C = 20 mA, I _B = 2.0 mA)		V _{BE(sat)}	–	0.9	Vdc
SMALL–SIGNAL CHARACTERISTICS					
Current–Gain – Bandwidth Product (I _C = 10 mA, V _{CE} = 20 Vdc, f = 100 MHz)		f _T	50	–	MHz
Collector–Base Capacitance (V _{CB} = 20 Vdc, I _E = 0, f = 1.0 MHz)	MMBTA42 MMBTA43	C _{cb}	– –	3.0 4.0	pF

3. Pulse Test: Pulse Width ≤ 300 μs, Duty Cycle ≤ 2.0%.

MMBTA42LT1, MMBTA43LT1

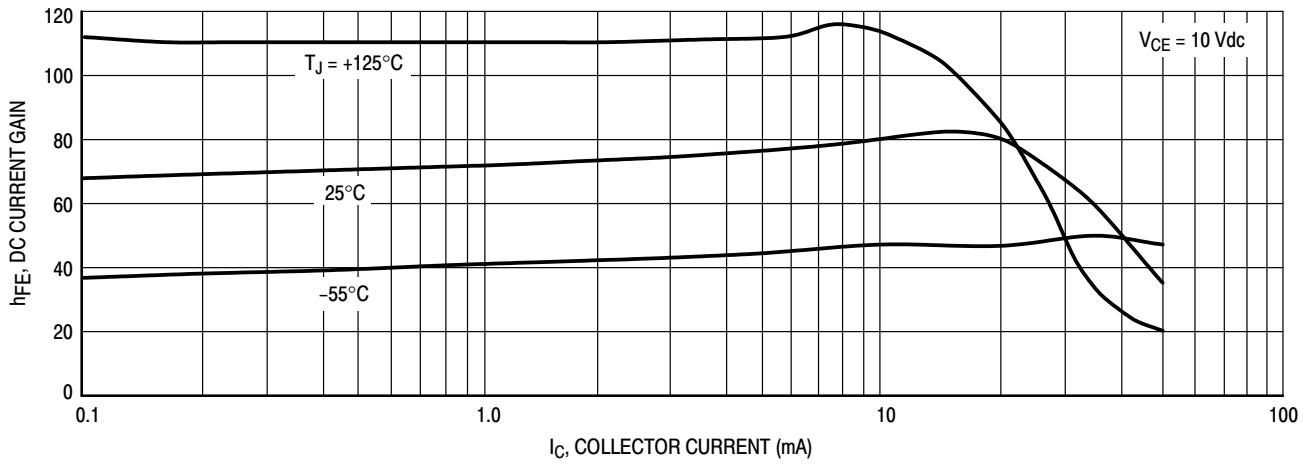

Figure 1. DC Current Gain

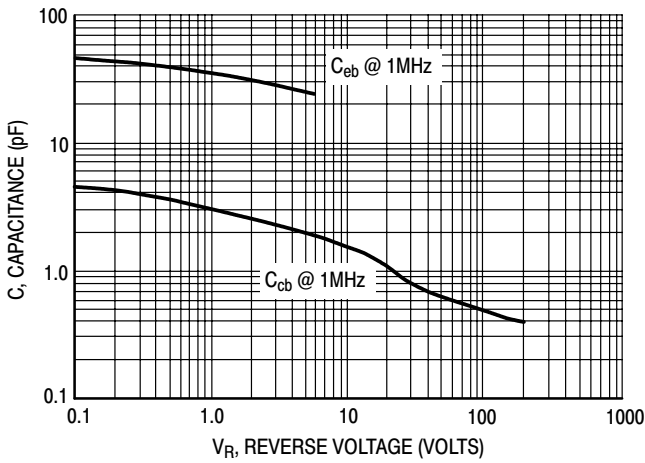

Figure 2. Capacitance

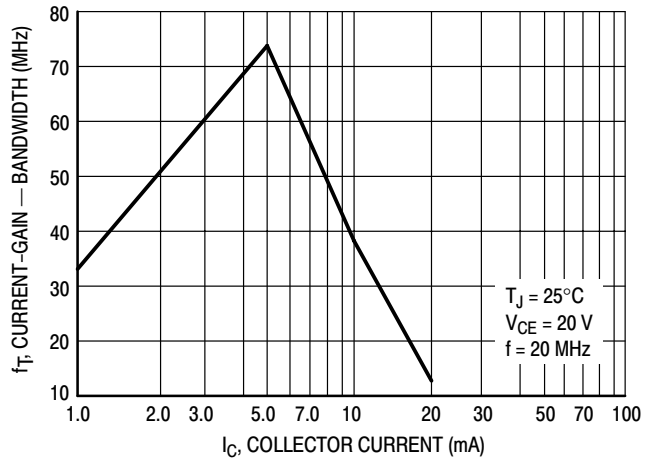

Figure 3. Current-Gain - Bandwidth

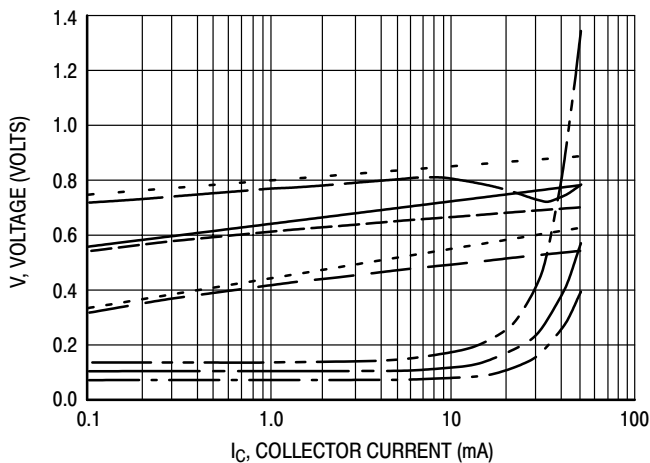

Figure 4. "ON" Voltages

- $V_{CE(sat)}$ @ 25°C, $I_C/I_B = 10$
- $V_{CE(sat)}$ @ 125°C, $I_C/I_B = 10$
- $V_{CE(sat)}$ @ -55°C, $I_C/I_B = 10$
- $V_{BE(sat)}$ @ 25°C, $I_C/I_B = 10$
- $V_{BE(sat)}$ @ 125°C, $I_C/I_B = 10$
- $V_{BE(sat)}$ @ -55°C, $I_C/I_B = 10$
- $V_{BE(on)}$ @ 25°C, $V_{CE} = 10$ V
- $V_{BE(on)}$ @ 125°C, $V_{CE} = 10$ V
- $V_{BE(on)}$ @ -55°C, $V_{CE} = 10$ V

MMBTA42LT1, MMBTA43LT1

PACKAGE DIMENSIONS

SOT-23 (TO-236) CASE 318-08 ISSUE AH

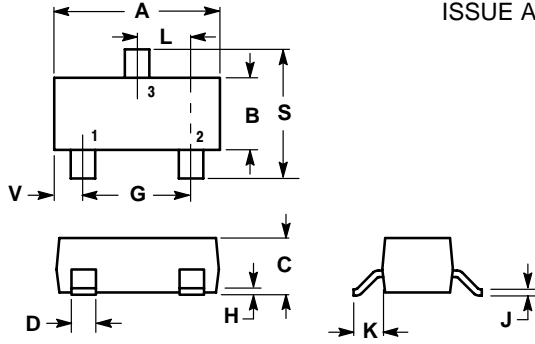

- NOTES:
1. DIMENSIONING AND TOLERANCING PER ANSI Y14.5M, 1982.
 2. CONTROLLING DIMENSION: INCH.
 3. MAXIMUM LEAD THICKNESS INCLUDES LEAD FINISH THICKNESS. MINIMUM LEAD THICKNESS IS THE MINIMUM THICKNESS OF BASE MATERIAL.
 4. 318-03 AND -07 OBSOLETE, NEW STANDARD 318-08.

DIM	INCHES		MILLIMETERS	
	MIN	MAX	MIN	MAX
A	0.1102	0.1197	2.80	3.04
B	0.0472	0.0551	1.20	1.40
C	0.0350	0.0440	0.89	1.11
D	0.0150	0.0200	0.37	0.50
G	0.0701	0.0807	1.78	2.04
H	0.0005	0.0040	0.013	0.100
J	0.0034	0.0070	0.085	0.177
K	0.0140	0.0285	0.35	0.69
L	0.0350	0.0401	0.89	1.02
S	0.0830	0.1039	2.10	2.64
V	0.0177	0.0236	0.45	0.60

- STYLE 6:
1. BASE
 2. EMITTER
 3. COLLECTOR

SOLDERING FOOTPRINT*

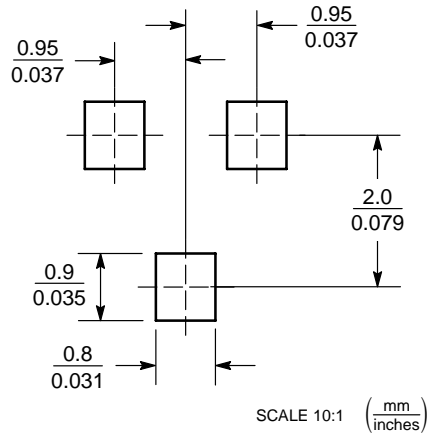



Figure 5. SOT-23

*For additional information on our Pb-Free strategy and soldering details, please download the ON Semiconductor Soldering and Mounting Techniques Reference Manual, SOLDERRM/D.

ON Semiconductor and  are registered trademarks of Semiconductor Components Industries, LLC (SCILLC). SCILLC reserves the right to make changes without further notice to any products herein. SCILLC makes no warranty, representation or guarantee regarding the suitability of its products for any particular purpose, nor does SCILLC assume any liability arising out of the application or use of any product or circuit, and specifically disclaims any and all liability, including without limitation special, consequential or incidental damages. "Typical" parameters which may be provided in SCILLC data sheets and/or specifications can and do vary in different applications and actual performance may vary over time. All operating parameters, including "Typicals" must be validated for each customer application by customer's technical experts. SCILLC does not convey any license under its patent rights nor the rights of others. SCILLC products are not designed, intended, or authorized for use as components in systems intended for surgical implant into the body, or other applications intended to support or sustain life, or for any other application in which the failure of the SCILLC product could create a situation where personal injury or death may occur. Should Buyer purchase or use SCILLC products for any such unintended or unauthorized application, Buyer shall indemnify and hold SCILLC and its officers, employees, subsidiaries, affiliates, and distributors harmless against all claims, costs, damages, and expenses, and reasonable attorney fees arising out of, directly or indirectly, any claim of personal injury or death associated with such unintended or unauthorized use, even if such claim alleges that SCILLC was negligent regarding the design or manufacture of the part. SCILLC is an Equal Opportunity/Affirmative Action Employer. This literature is subject to all applicable copyright laws and is not for resale in any manner.

PUBLICATION ORDERING INFORMATION

LITERATURE FULFILLMENT:
Literature Distribution Center for ON Semiconductor
P.O. Box 5163, Denver, Colorado 80217 USA
Phone: 303-675-2175 or 800-344-3860 Toll Free USA/Canada
Fax: 303-675-2176 or 800-344-3867 Toll Free USA/Canada
Email: orderlit@onsemi.com

N. American Technical Support: 800-282-9855 Toll Free
USA/Canada

Japan: ON Semiconductor, Japan Customer Focus Center
2-9-1 Kamimeguro, Meguro-ku, Tokyo, Japan 153-0051
Phone: 81-3-5773-3850

ON Semiconductor Website: <http://onsemi.com>

Order Literature: <http://www.onsemi.com/litorder>

For additional information, please contact your local Sales Representative.