

SN74LS194A

4-Bit Bidirectional Universal Shift Register

The SN74LS194A is a High Speed 4-Bit Bidirectional Universal Shift Register. As a high speed multifunctional sequential building block, it is useful in a wide variety of applications. It may be used in serial-serial, shift left, shift right, serial-parallel, parallel-serial, and parallel-parallel data register transfers. The LS194A is similar in operation to the LS195A Universal Shift Register, with added features of shift left without external connections and hold (do nothing) modes of operation. It utilizes the Schottky diode clamped process to achieve high speeds and is fully compatible with all ON Semiconductor TTL families.

- Typical Shift Frequency of 36 MHz
- Asynchronous Master Reset
- Hold (Do Nothing) Mode
- Fully Synchronous Serial or Parallel Data Transfers
- Input Clamp Diodes Limit High Speed Termination Effects

GUARANTEED OPERATING RANGES

Symbol	Parameter	Min	Typ	Max	Unit
V_{CC}	Supply Voltage	4.75	5.0	5.25	V
T_A	Operating Ambient Temperature Range	0	25	70	°C
I_{OH}	Output Current – High			-0.4	mA
I_{OL}	Output Current – Low			8.0	mA



ON Semiconductor
Formerly a Division of Motorola
<http://onsemi.com>

**LOW
POWER
SCHOTTKY**

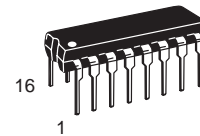

PLASTIC
N SUFFIX
CASE 648

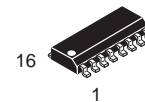

SOIC
D SUFFIX
CASE 751B

ORDERING INFORMATION

Device	Package	Shipping
SN74LS194AN	16 Pin DIP	2000 Units/Box
SN74LS194AD	16 Pin	2500/Tape & Reel

SN74LS194A

CONNECTION DIAGRAM DIP (TOP VIEW)

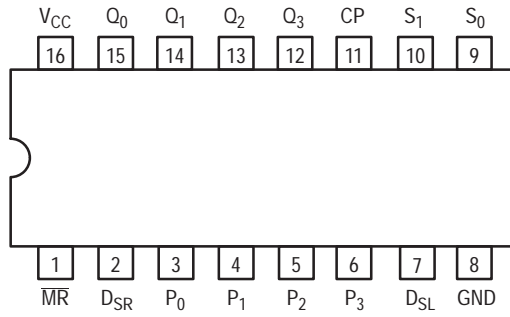

PIN NAMES

S ₀ , S ₁	Mode Control Inputs
P ₀ – P ₃	Parallel Data Inputs
D _{SR}	Serial (Shift Right) Data Input
D _{SL}	Serial (Shift Left) Data Input
CP	Clock (Active HIGH Going Edge) Input
$\overline{\text{MR}}$	Master Reset (Active LOW) Input
Q ₀ – Q ₃	Parallel Outputs

LOADING (Note a)

	HIGH	LOW
S ₀ , S ₁	0.5 U.L.	0.25 U.L.
P ₀ – P ₃	0.5 U.L.	0.25 U.L.
D _{SR}	0.5 U.L.	0.25 U.L.
D _{SL}	0.5 U.L.	0.25 U.L.
CP	0.5 U.L.	0.25 U.L.
$\overline{\text{MR}}$	0.5 U.L.	0.25 U.L.
Q ₀ – Q ₃	10 U.L.	5 U.L.

NOTES:

a) 1 TTL Unit Load (U.L.) = 40 μ A HIGH/1.6 mA LOW.

SN74LS194A

LOGIC DIAGRAM

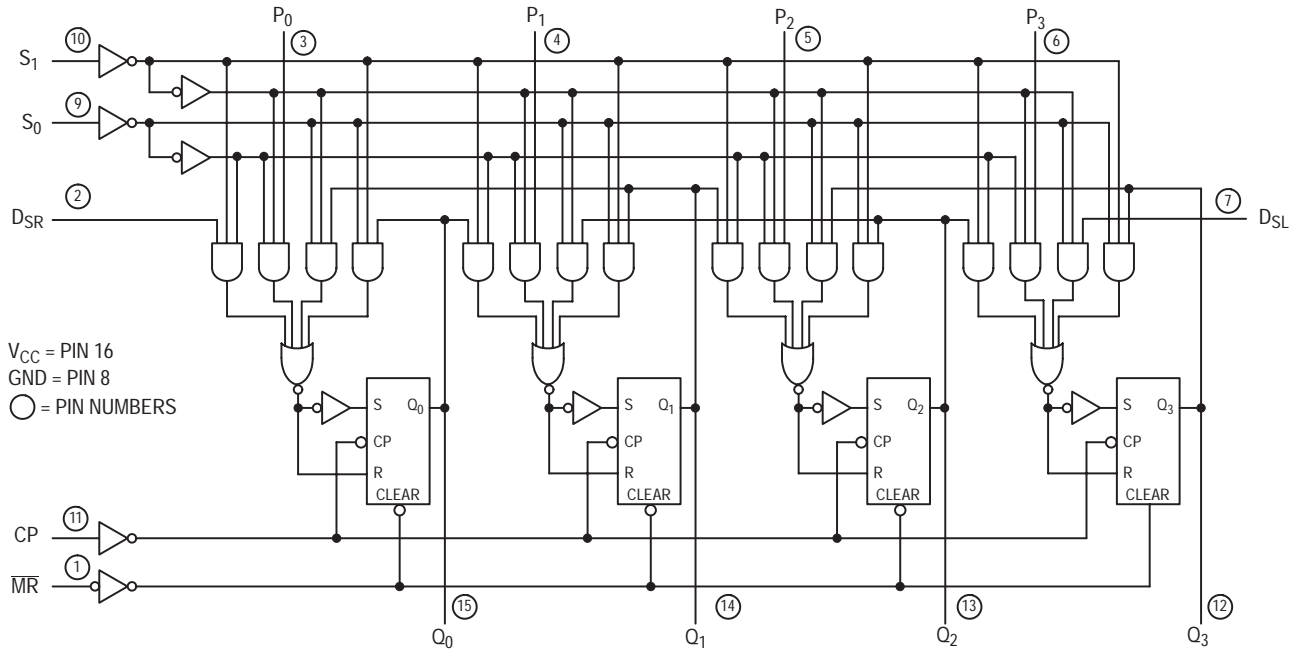

FUNCTIONAL DESCRIPTION

The Logic Diagram and Truth Table indicate the functional characteristics of the LS194A 4-Bit Bidirectional Shift Register. The LS194A is similar in operation to the ON Semiconductor LS195A Universal Shift Register when used in serial or parallel data register transfers. Some of the common features of the two devices are described below:

All data and mode control inputs are edge-triggered, responding only to the LOW to HIGH transition of the Clock (CP). The only timing restriction, therefore, is that the mode control and selected data inputs must be stable one set-up time prior to the positive transition of the clock pulse.

The register is fully synchronous, with all operations taking place in less than 15 ns (typical) making the device especially useful for implementing very high speed CPUs, or the memory buffer registers.

The four parallel data inputs (P_0 , P_1 , P_2 , P_3) are D-type inputs. When both S_0 and S_1 are HIGH, the data appearing on P_0 , P_1 , P_2 , and P_3 inputs is transferred to the Q_0 , Q_1 , Q_2 , and Q_3 outputs respectively following the next LOW to HIGH transition of the clock.

The asynchronous Master Reset (\overline{MR}), when LOW, overrides all other input conditions and forces the Q outputs LOW.

Special logic features of the LS194A design which increase the range of application are described below:

Two mode control inputs (S_0 , S_1) determine the synchronous operation of the device. As shown in the Mode Selection Table, data can be entered and shifted from left to right (shift right, $Q_0 \rightarrow Q_1$, etc.) or right to left (shift left, $Q_3 \rightarrow Q_2$, etc.), or parallel data can be entered loading all four bits of the register simultaneously. When both S_0 and S_1 are LOW, the existing data is retained in a "do nothing" mode without restricting the HIGH to LOW clock transition.

D-type serial data inputs (D_{SR} , D_{SL}) are provided on both the first and last stages to allow multistage shift right or shift left data transfers without interfering with parallel load operation.

SN74LS194A

MODE SELECT — TRUTH TABLE

OPERATING MODE	INPUTS						OUTPUTS			
	MR	S ₁	S ₀	D _{SR}	D _{SL}	P _n	Q ₀	Q ₁	Q ₂	Q ₃
Reset	L	X	X	X	X	X	L	L	L	L
Hold	H	l	l	X	X	X	q ₀	q ₁	q ₂	q ₃
Shift Left	H	h	l	X	l	X	q ₁	q ₂	q ₃	L
	H	h	l	X	h	X	q ₁	q ₂	q ₃	H
Shift Right	H	l	h	l	X	X	L	q ₀	q ₁	q ₂
	H	l	h	h	X	X	H	q ₀	q ₁	q ₂
Parallel Load	H	h	h	X	X	P _n	P ₀	P ₁	P ₂	P ₃

L = LOW Voltage Level

H = HIGH Voltage Level

X = Don't Care

l = LOW voltage level one set-up time prior to the LOW to HIGH clock transition

h = HIGH voltage level one set-up time prior to the LOW to HIGH clock transition

p_n (q_n) = Lower case letters indicate the state of the referenced input (or output) one set-up time prior to the LOW to HIGH clock transition.

DC CHARACTERISTICS OVER OPERATING TEMPERATURE RANGE (unless otherwise specified)

Symbol	Parameter	Limits			Unit	Test Conditions
		Min	Typ	Max		
V _{IH}	Input HIGH Voltage	2.0			V	Guaranteed Input HIGH Voltage for All Inputs
V _{IL}	Input LOW Voltage			0.8	V	Guaranteed Input LOW Voltage for All Inputs
V _{IK}	Input Clamp Diode Voltage		-0.65	-1.5	V	V _{CC} = MIN, I _{IN} = -18 mA
V _{OH}	Output HIGH Voltage	2.7	3.5		V	V _{CC} = MIN, I _{OH} = MAX, V _{IN} = V _{IH} or V _{IL} per Truth Table
V _{OL}	Output LOW Voltage		0.25	0.4	V	I _{OL} = 4.0 mA V _{CC} = V _{CC} MIN, V _{IN} = V _{IL} or V _{IH} per Truth Table
			0.35	0.5	V	
I _{IH}	Input HIGH Current			20	μA	V _{CC} = MAX, V _{IN} = 2.7 V
				0.1	mA	V _{CC} = MAX, V _{IN} = 7.0 V
I _{IL}	Input LOW Current			-0.4	mA	V _{CC} = MAX, V _{IN} = 0.4 V
I _{OS}	Short Circuit Current (Note 1)	-20		-100	mA	V _{CC} = MAX
I _{CC}	Power Supply Current			23	mA	V _{CC} = MAX

Note 1: Not more than one output should be shorted at a time, nor for more than 1 second.

AC CHARACTERISTICS (T_A = 25°C)

Symbol	Parameter	Limits			Unit	Test Conditions
		Min	Typ	Max		
f _{MAX}	Maximum Clock Frequency	25	36		MHz	V _{CC} = 5.0 V C _L = 15 pF
t _{PLH} t _{PHL}	Propagation Delay, Clock to Output		14 17	22 26	ns	
t _{PHL}	Propagation Delay, MR to Output		19	30	ns	

SN74LS194A

AC SETUP REQUIREMENTS ($T_A = 25^\circ\text{C}$)

Symbol	Parameter	Limits			Unit	Test Conditions
		Min	Typ	Max		
t_W	Clock or $\overline{\text{MR}}$ Pulse Width	20			ns	$V_{CC} = 5.0\text{ V}$
t_s	Mode Control Setup Time	30			ns	
t_s	Data Setup Time	20			ns	
t_h	Hold time, Any Input	0			ns	
t_{rec}	Recovery Time	25			ns	

DEFINITIONS OF TERMS

SETUP TIME (t_s) — is defined as the minimum time required for the correct logic level to be present at the logic input prior to the clock transition from LOW to HIGH in order to be recognized and transferred to the outputs.

HOLD TIME (t_h) — is defined as the minimum time following the clock transition from LOW to HIGH that the logic level must be maintained at the input in order to ensure

continued recognition. A negative HOLD TIME indicates that the correct logic level may be released prior to the clock transition from LOW to HIGH and still be recognized.

RECOVERY TIME (t_{rec}) — is defined as the minimum time required between the end of the reset pulse and the clock transition from LOW to HIGH in order to recognize and transfer HIGH Data to the Q outputs.

AC WAVEFORMS

The shaded areas indicate when the input is permitted to change for predictable output performance.

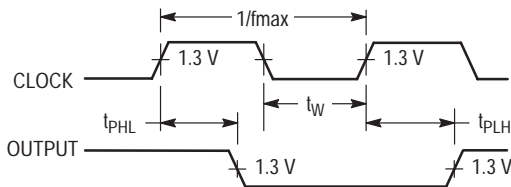

OTHER CONDITIONS: $S_1 = L, \overline{\text{MR}} = H, S_0 = H$

Figure 1. Clock to Output Delays Clock Pulse Width and f_{max}

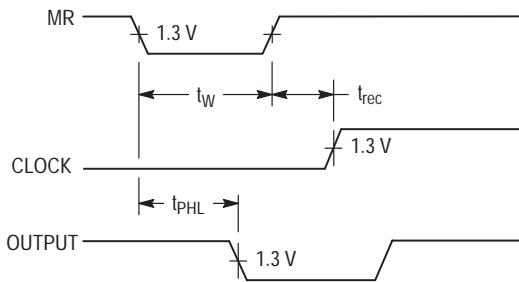

OTHER CONDITIONS: $S_0, S_1 = H$
 $P_0 = P_1 = P_2 = P_3 = H$

Figure 2. Master Reset Pulse Width, Master Reset to Output Delay and Master Reset to Clock Recovery Time

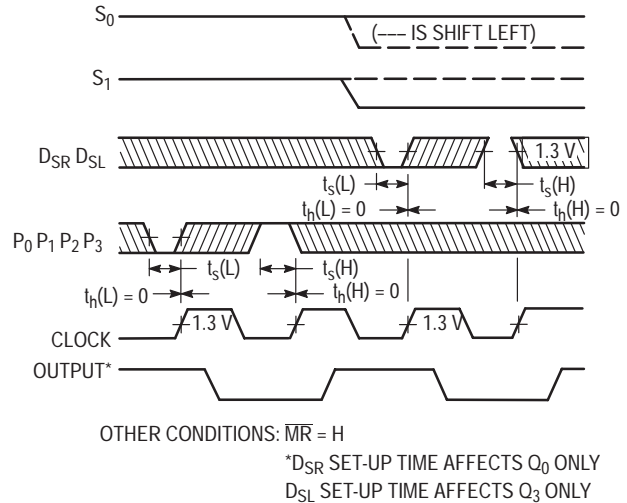

Figure 3. Setup (t_s) and Hold (t_h) Time for Serial Data ($D_{\text{SR}}, D_{\text{SL}}$) and Parallel Data (P_0, P_1, P_2, P_3)

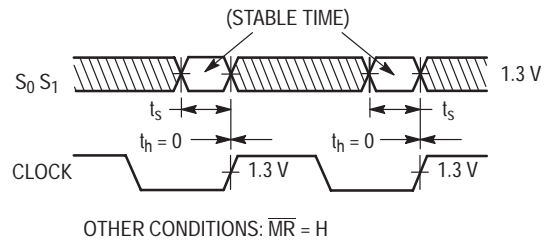
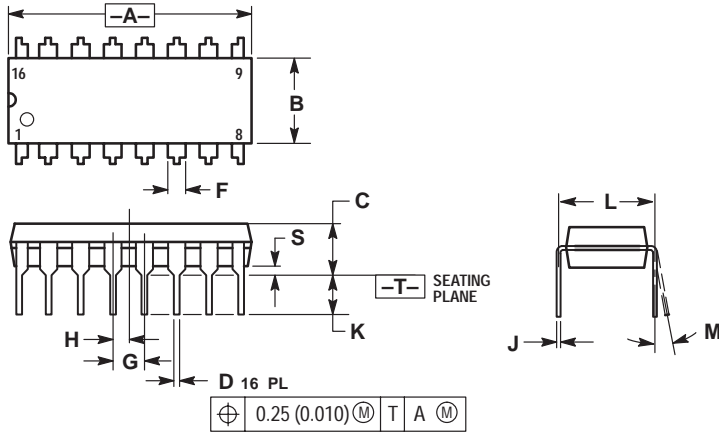

Figure 4. Setup (t_s) and Hold (t_h) Time for S Input

SN74LS194A

PACKAGE DIMENSIONS

N SUFFIX
PLASTIC PACKAGE
CASE 648-08
ISSUE R



NOTES:

1. DIMENSIONING AND TOLERANCING PER ANSI Y14.5M, 1982.
2. CONTROLLING DIMENSION: INCH.
3. DIMENSION L TO CENTER OF LEADS WHEN FORMED PARALLEL.
4. DIMENSION B DOES NOT INCLUDE MOLD FLASH.
5. ROUNDED CORNERS OPTIONAL.

DIM	INCHES		MILLIMETERS	
	MIN	MAX	MIN	MAX
A	0.740	0.770	18.80	19.55
B	0.250	0.270	6.35	6.85
C	0.145	0.175	3.69	4.44
D	0.015	0.021	0.39	0.53
F	0.040	0.70	1.02	1.77
G	0.100 BSC		2.54 BSC	
H	0.050 BSC		1.27 BSC	
J	0.008	0.015	0.21	0.38
K	0.110	0.130	2.80	3.30
L	0.295	0.305	7.50	7.74
M	0° 10°		0° 10°	
S	0.020	0.040	0.51	1.01

SN74LS194A

D SUFFIX PLASTIC SOIC PACKAGE CASE 751B-05 ISSUE J

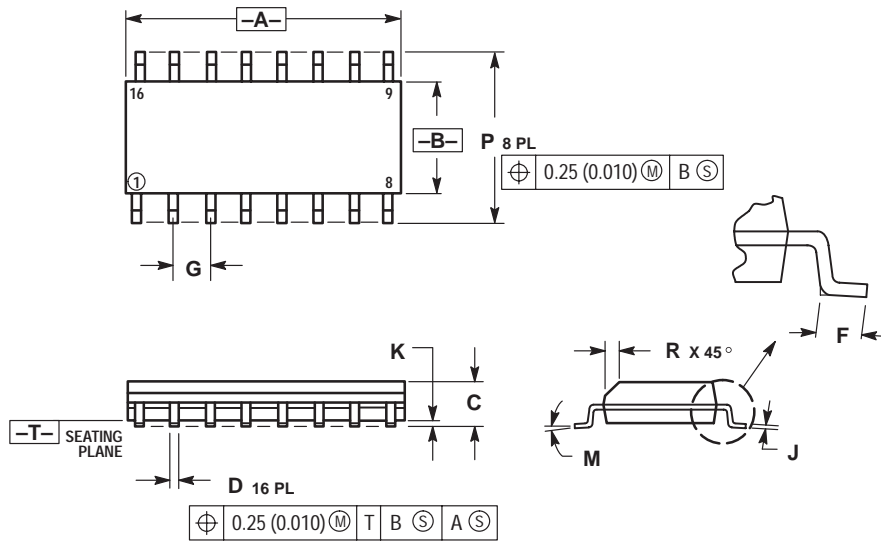

NOTES:

1. DIMENSIONING AND TOLERANCING PER ANSI Y14.5M, 1982.
2. CONTROLLING DIMENSION: MILLIMETER.
3. DIMENSIONS A AND B DO NOT INCLUDE MOLD PROTRUSION.
4. MAXIMUM MOLD PROTRUSION 0.15 (0.006) PER SIDE.
5. DIMENSION D DOES NOT INCLUDE DAMBAR PROTRUSION. ALLOWABLE DAMBAR PROTRUSION SHALL BE 0.127 (0.005) TOTAL IN EXCESS OF THE D DIMENSION AT MAXIMUM MATERIAL CONDITION.

DIM	MILLIMETERS		INCHES	
	MIN	MAX	MIN	MAX
A	9.80	10.00	0.386	0.393
B	3.80	4.00	0.150	0.157
C	1.35	1.75	0.054	0.068
D	0.35	0.49	0.014	0.019
F	0.40	1.25	0.016	0.049
G	1.27 BSC		0.050 BSC	
J	0.19	0.25	0.008	0.009
K	0.10	0.25	0.004	0.009
M	0° 7°		0° 7°	
P	5.80	6.20	0.229	0.244
R	0.25	0.50	0.010	0.019

ON Semiconductor and  are trademarks of Semiconductor Components Industries, LLC (SCILLC). SCILLC reserves the right to make changes without further notice to any products herein. SCILLC makes no warranty, representation or guarantee regarding the suitability of its products for any particular purpose, nor does SCILLC assume any liability arising out of the application or use of any product or circuit, and specifically disclaims any and all liability, including without limitation special, consequential or incidental damages. "Typical" parameters which may be provided in SCILLC data sheets and/or specifications can and do vary in different applications and actual performance may vary over time. All operating parameters, including "Typicals" must be validated for each customer application by customer's technical experts. SCILLC does not convey any license under its patent rights nor the rights of others. SCILLC products are not designed, intended, or authorized for use as components in systems intended for surgical implant into the body, or other applications intended to support or sustain life, or for any other application in which the failure of the SCILLC product could create a situation where personal injury or death may occur. Should Buyer purchase or use SCILLC products for any such unintended or unauthorized application, Buyer shall indemnify and hold SCILLC and its officers, employees, subsidiaries, affiliates, and distributors harmless against all claims, costs, damages, and expenses, and reasonable attorney fees arising out of, directly or indirectly, any claim of personal injury or death associated with such unintended or unauthorized use, even if such claim alleges that SCILLC was negligent regarding the design or manufacture of the part. SCILLC is an Equal Opportunity/Affirmative Action Employer.

PUBLICATION ORDERING INFORMATION

North America Literature Fulfillment:

Literature Distribution Center for ON Semiconductor
P.O. Box 5163, Denver, Colorado 80217 USA
Phone: 303-675-2175 or 800-344-3860 Toll Free USA/Canada
Fax: 303-675-2176 or 800-344-3867 Toll Free USA/Canada
Email: ONlit@hibbertco.com

N. American Technical Support: 800-282-9855 Toll Free USA/Canada

EUROPE: LDC for ON Semiconductor – European Support

German Phone: (+1) 303-308-7140 (M-F 2:30pm to 5:00pm Munich Time)
Email: ONlit-german@hibbertco.com
French Phone: (+1) 303-308-7141 (M-F 2:30pm to 5:00pm Toulouse Time)
Email: ONlit-french@hibbertco.com
English Phone: (+1) 303-308-7142 (M-F 1:30pm to 5:00pm UK Time)
Email: ONlit@hibbertco.com

ASIA/PACIFIC: LDC for ON Semiconductor – Asia Support

Phone: 303-675-2121 (Tue-Fri 9:00am to 1:00pm, Hong Kong Time)
Toll Free from Hong Kong 800-4422-3781
Email: ONlit-asia@hibbertco.com

JAPAN: ON Semiconductor, Japan Customer Focus Center

4-32-1 Nishi-Gotanda, Shinagawa-ku, Tokyo, Japan 141-8549
Phone: 81-3-5487-8345
Email: r14153@onsemi.com

Fax Response Line: 303-675-2167
800-344-3810 Toll Free USA/Canada

ON Semiconductor Website: <http://onsemi.com>

For additional information, please contact your local Sales Representative.