

# PNZ109CL

## Silicon NPN Phototransistor

For optical control systems

### ■ Features

- High sensitivity :  $I_{CE(L)} = 2 \text{ mA (min.)}$  (at  $L = 500 \text{ lx}$ )
- Wide directional sensitivity for easy use
- Fast response :  $t_r = 5 \mu\text{s}$  (typ.)
- Signal mixing capability using base pin
- Small size (low in height) package
- Resin to cutoff visible light is used

### ■ Absolute Maximum Ratings ( $T_a = 25^\circ\text{C}$ )

Parameter	Symbol	Ratings	Unit
Collector to emitter voltage	$V_{CEO}$	20	V
Collector to base voltage	$V_{CBO}$	30	V
Emitter to collector voltage	$V_{ECO}$	3	V
Emitter to base voltage	$V_{EBO}$	5	V
Collector current	$I_C$	20	mA
Collector power dissipation	$P_C$	100	mW
Operating ambient temperature	$T_{opr}$	-25 to +85	$^\circ\text{C}$
Storage temperature	$T_{stg}$	-30 to +100	$^\circ\text{C}$

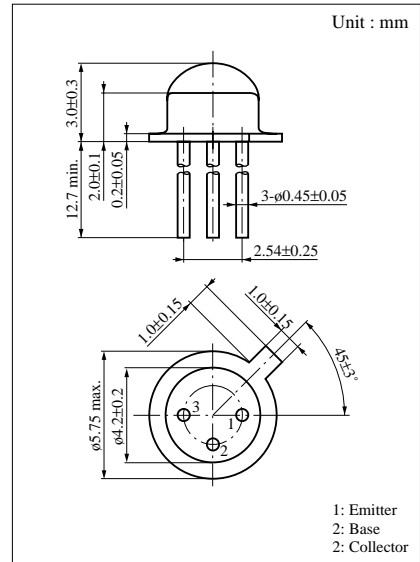

### ■ Electro-Optical Characteristics ( $T_a = 25^\circ\text{C}$ )

Parameter	Symbol	Conditions	min	typ	max	Unit
Dark current	$I_{CEO}$	$V_{CE} = 10\text{V}$		0.05	2	$\mu\text{A}$
Collector photo current	$I_{CE(L)}$	$V_{CE} = 10\text{V}, L = 500 \text{ lx}^{*1}$	2.5	4		mA
Peak sensitivity wave length	$\lambda_P$	$V_{CE} = 10\text{V}$		900		nm
Acceptance half angle	$\theta$	Measured from the optical axis to the half power point		80		deg.
Rise time	$t_r^{*2}$	$V_{CC} = 10\text{V}, I_{CE(L)} = 5\text{mA}$		5		$\mu\text{s}$
Fall time	$t_f^{*2}$	$R_L = 100\Omega$		6		$\mu\text{s}$
Collector saturation voltage	$V_{CE(sat)}$	$I_{CE(L)} = 1\text{mA}, L = 1000 \text{ lx}^{*1}$		0.3	0.6	V

\*1 Measurements were made using a tungsten lamp (color temperature  $T = 2856\text{K}$ ) as a light source.

\*2 Switching time measurement circuit

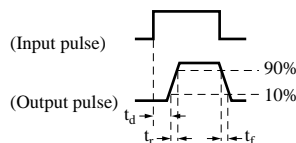
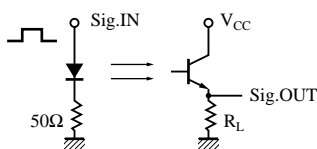

$t_d$ : Delay time

$t_r$ : Rise time (Time required for the collector photo current to increase from 10% to 90% of its final value)

$t_f$ : Fall time (Time required for the collector photo current to decrease from 90% to 10% of its initial value)

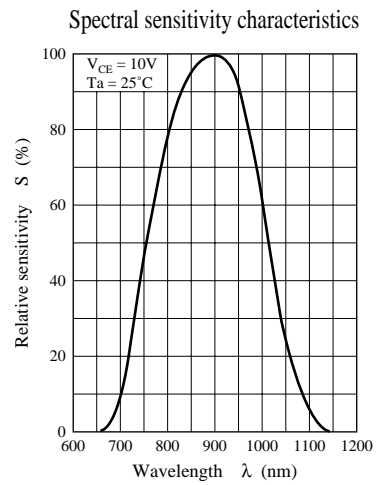
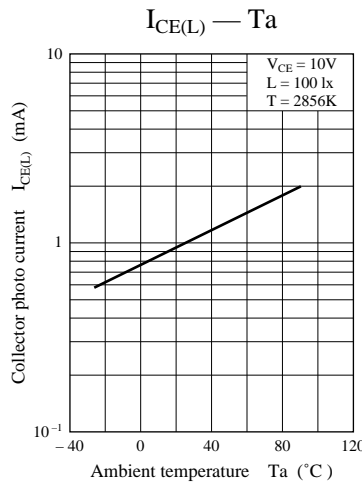
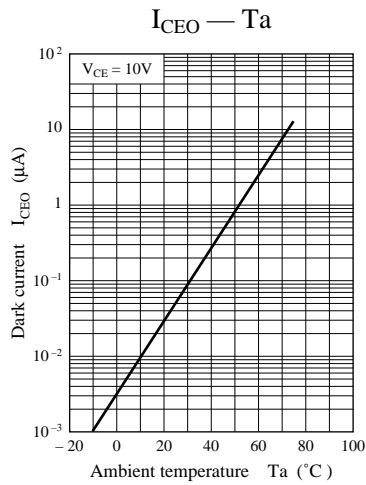
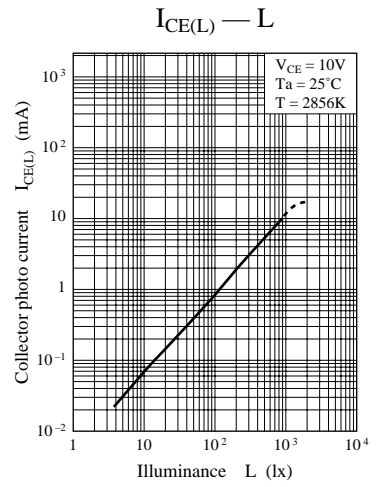
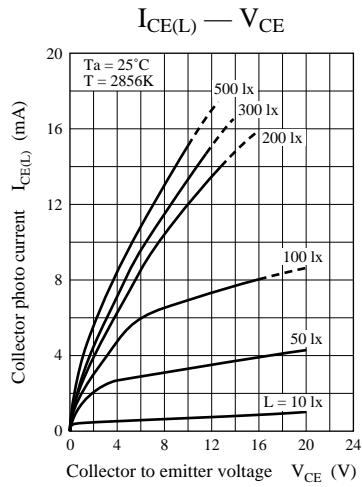
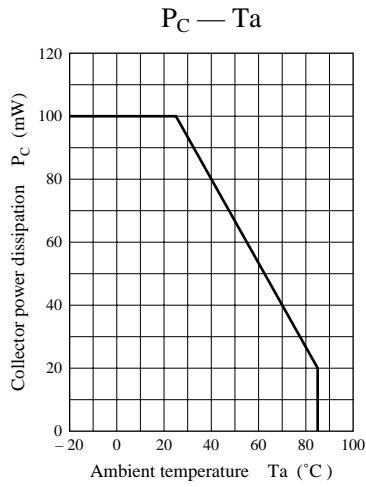

**Directivity characteristics**

