

To all our customers

Regarding the change of names mentioned in the document, such as Hitachi Electric and Hitachi XX, to Renesas Technology Corp.

The semiconductor operations of Mitsubishi Electric and Hitachi were transferred to Renesas Technology Corporation on April 1st 2003. These operations include microcomputer, logic, analog and discrete devices, and memory chips other than DRAMs (flash memory, SRAMs etc.) Accordingly, although Hitachi, Hitachi, Ltd., Hitachi Semiconductors, and other Hitachi brand names are mentioned in the document, these names have in fact all been changed to Renesas Technology Corp. Thank you for your understanding. Except for our corporate trademark, logo and corporate statement, no changes whatsoever have been made to the contents of the document, and these changes do not constitute any alteration to the contents of the document itself.

Renesas Technology Home Page: <http://www.renesas.com>

Renesas Technology Corp.
Customer Support Dept.
April 1, 2003

Cautions

Keep safety first in your circuit designs!

1. Renesas Technology Corporation puts the maximum effort into making semiconductor products better and more reliable, but there is always the possibility that trouble may occur with them. Trouble with semiconductors may lead to personal injury, fire or property damage.

Remember to give due consideration to safety when making your circuit designs, with appropriate measures such as (i) placement of substitutive, auxiliary circuits, (ii) use of nonflammable material or (iii) prevention against any malfunction or mishap.

Notes regarding these materials

1. These materials are intended as a reference to assist our customers in the selection of the Renesas Technology Corporation product best suited to the customer's application; they do not convey any license under any intellectual property rights, or any other rights, belonging to Renesas Technology Corporation or a third party.
2. Renesas Technology Corporation assumes no responsibility for any damage, or infringement of any third-party's rights, originating in the use of any product data, diagrams, charts, programs, algorithms, or circuit application examples contained in these materials.
3. All information contained in these materials, including product data, diagrams, charts, programs and algorithms represents information on products at the time of publication of these materials, and are subject to change by Renesas Technology Corporation without notice due to product improvements or other reasons. It is therefore recommended that customers contact Renesas Technology Corporation or an authorized Renesas Technology Corporation product distributor for the latest product information before purchasing a product listed herein.
The information described here may contain technical inaccuracies or typographical errors. Renesas Technology Corporation assumes no responsibility for any damage, liability, or other loss rising from these inaccuracies or errors.
Please also pay attention to information published by Renesas Technology Corporation by various means, including the Renesas Technology Corporation Semiconductor home page (<http://www.renesas.com>).
4. When using any or all of the information contained in these materials, including product data, diagrams, charts, programs, and algorithms, please be sure to evaluate all information as a total system before making a final decision on the applicability of the information and products. Renesas Technology Corporation assumes no responsibility for any damage, liability or other loss resulting from the information contained herein.
5. Renesas Technology Corporation semiconductors are not designed or manufactured for use in a device or system that is used under circumstances in which human life is potentially at stake. Please contact Renesas Technology Corporation or an authorized Renesas Technology Corporation product distributor when considering the use of a product contained herein for any specific purposes, such as apparatus or systems for transportation, vehicular, medical, aerospace, nuclear, or undersea repeater use.
6. The prior written approval of Renesas Technology Corporation is necessary to reprint or reproduce in whole or in part these materials.
7. If these products or technologies are subject to the Japanese export control restrictions, they must be exported under a license from the Japanese government and cannot be imported into a country other than the approved destination.
Any diversion or reexport contrary to the export control laws and regulations of Japan and/or the country of destination is prohibited.
8. Please contact Renesas Technology Corporation for further details on these materials or the products contained therein.

H7N0312AB

Silicon N Channel MOS FET
High Speed Power Switching

RENESAS

ADE-208-1571B(Z)

3rd. Edition
Aug. 2002

Features

- Low on-resistance
- $R_{DS(on)} = 2.6\text{m}\Omega$ typ.
- Low drive current
- 4.5 V gate drive device can be driven from 5 V source

Outline

TO-220AB

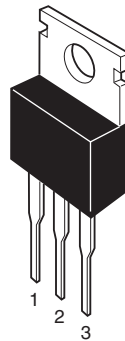
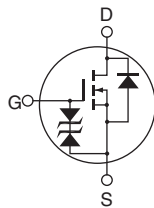

1. Gate
2. Drain
(Frangle)
3. Source

Absolute Maximum Ratings

(Ta = 25°C)

Item	Symbol	Ratings	Unit
Drain to source voltage	V _{DSS}	30	V
Gate to source voltage	V _{GSS}	±20	V
Drain current	I _D	85	A
Drain peak current	I _{D(pulse)} ^{Note 1}	340	A
Body-drain diode reverse drain current	I _{DR}	85	A
Channel dissipation	Pch ^{Note 2}	125	W
Channel to Case Thermal Impedance	θch-c	1.0	°C/W
Channel temperature	Tch	150	°C
Storage temperature	Tstg	-55 to +150	°C

Notes: 1. PW ≤ 10 μs, duty cycle ≤ 1 %

2. Value at Tc = 25°C

Electrical Characteristics

(Ta = 25°C)

Item	Symbol	Min	Typ	Max	Unit	Test Conditions
Drain to source breakdown voltage	$V_{(BR)DSS}$	30	—	—	V	$I_D = 10 \text{ mA}, V_{GS} = 0$
Gate to source breakdown voltage	$V_{(BR)GSS}$	±20	—	—	V	$I_G = \pm 100 \text{ } \mu\text{A}, V_{DS} = 0$
Gate to source leak current	I_{GSS}	—	—	±10	μA	$V_{GS} = \pm 16 \text{ V}, V_{DS} = 0$
Zero gate voltage drain current	I_{DSS}	—	—	10	μA	$V_{DS} = 30 \text{ V}, V_{GS} = 0$
Gate to source cutoff voltage	$V_{GS(off)}$	1.0	—	2.5	V	$I_D = 1 \text{ mA}, V_{DS} = 10 \text{ V}^{\text{Note1}}$
Static drain to source on state resistance	$R_{DS(on)}$	—	2.6	3.3	mΩ	$I_D = 42.5 \text{ A}, V_{GS} = 10 \text{ V}^{\text{Note1}}$
		—	4.0	5.8	mΩ	$I_D = 42.5 \text{ A}, V_{GS} = 4.5 \text{ V}^{\text{Note1}}$
Forward transfer admittance	$ y_{fs} $	75	125	—	S	$I_D = 42.5 \text{ A}, V_{DS} = 10 \text{ V}^{\text{Note1}}$
Input capacitance	C_{iss}	—	6900	—	pF	$V_{DS} = 10 \text{ V}$
Output capacitance	C_{oss}	—	1750	—	pF	$V_{GS} = 0$
Reverse transfer capacitance	C_{rss}	—	820	—	pF	$f = 1 \text{ MHz}$
Total gate charge	Q_g	—	115	—	nc	$V_{DD} = 10 \text{ V}$
Gate to source charge	Q_{gs}	—	24	—	nc	$V_{GS} = 10 \text{ V}$
Gate to drain charge	Q_{gd}	—	24	—	nc	$I_D = 85 \text{ A}$
Turn-on delay time	$t_{d(on)}$	—	45	—	ns	$V_{GS} = 10 \text{ V}, I_D = 42.5 \text{ A}$
Rise time	t_r	—	380	—	ns	$R_L = 0.24 \text{ } \Omega$
Turn-off delay time	$t_{d(off)}$	—	125	—	ns	$R_g = 4.7 \text{ } \Omega$
Fall time	t_f	—	50	—	ns	
Body-drain diode forward voltage	V_{DF}	—	0.92	—	V	$I_F = 85 \text{ A}, V_{GS} = 0$
Body-drain diode reverse recovery time	t_{rr}	—	75	—	ns	$I_F = 85 \text{ A}, V_{GS} = 0$ $di_F/dt = 50 \text{ A}/\mu\text{s}$

Notes: 1. Pulse test

Main Characteristics

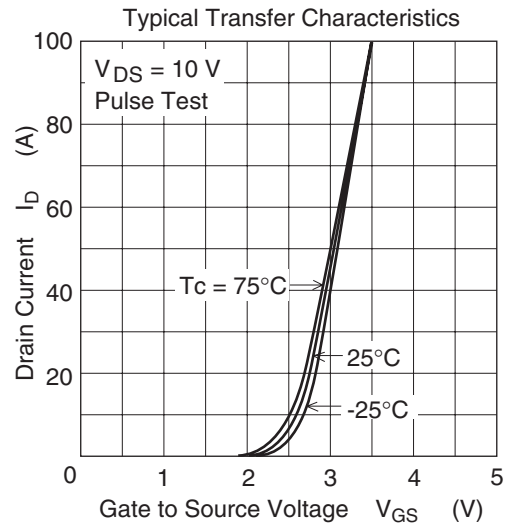
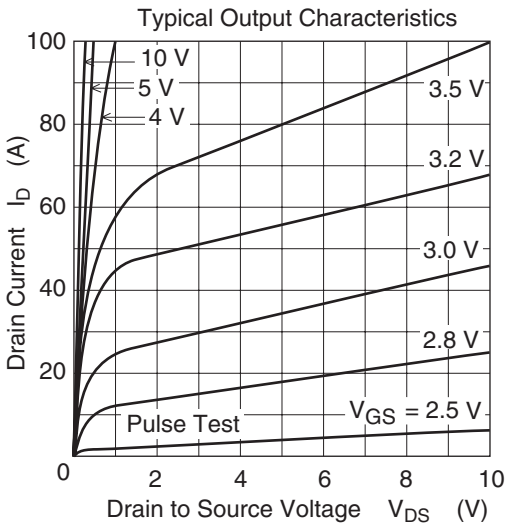
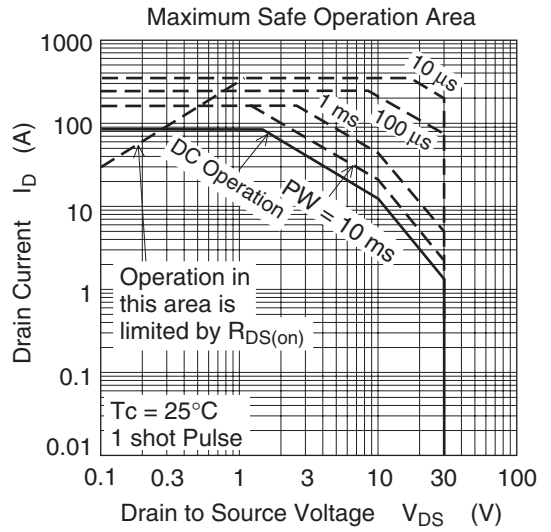
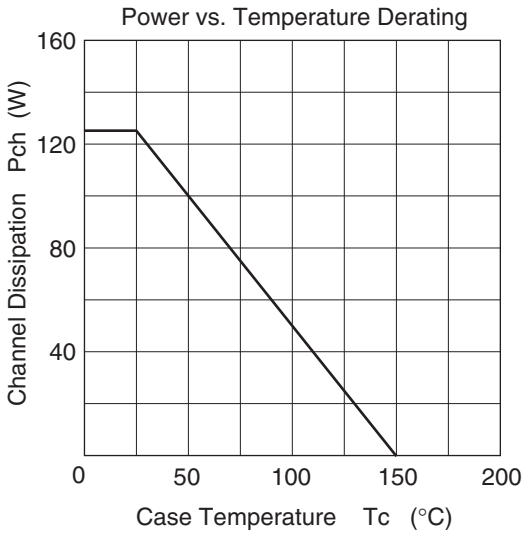

Drain to Source Saturation Voltage vs. Gate to Source Voltage

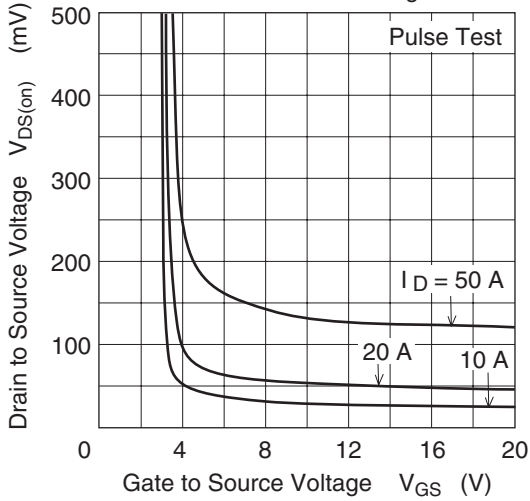

Static Drain to Source on State Resistance vs. Drain Current

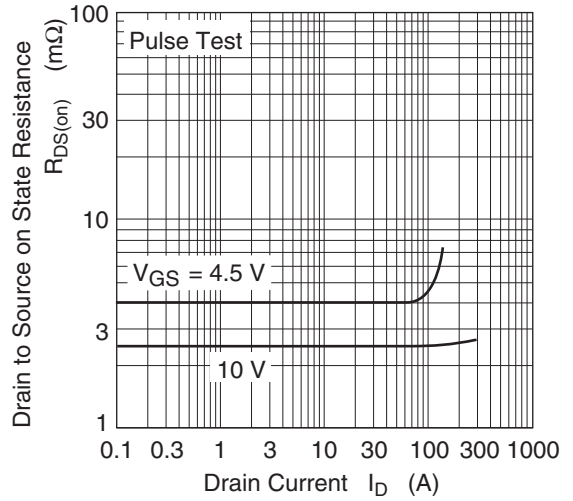

Static Drain to Source on State Resistance vs. Temperature

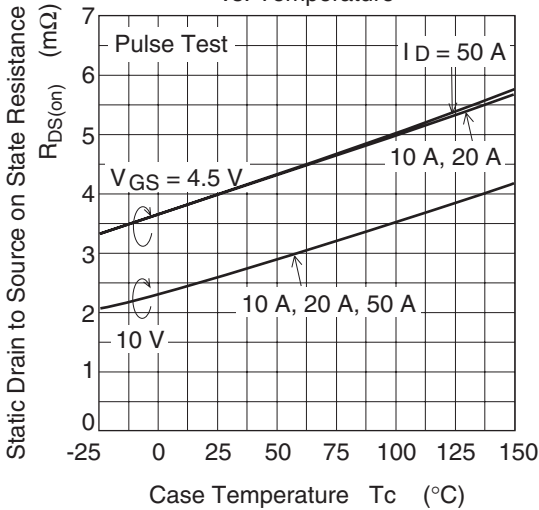

Forward Transfer Admittance vs. Drain Current

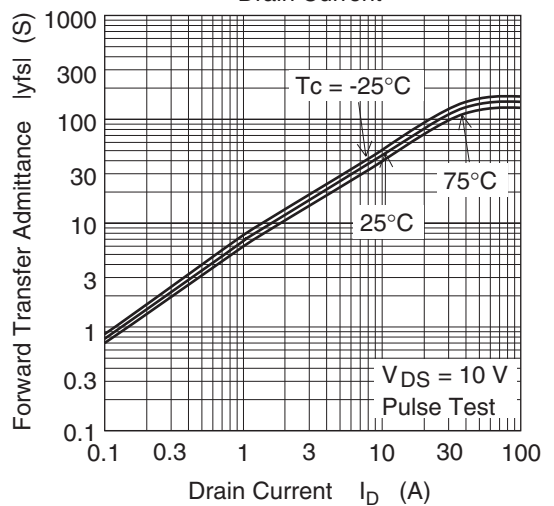

Body-Drain Diode Reverse Recovery Time

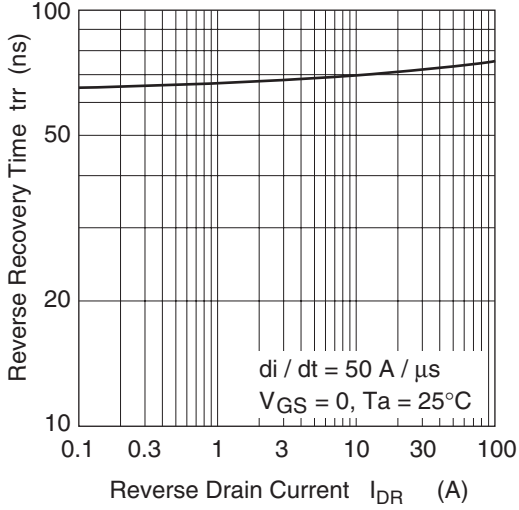

Typical Capacitance vs. Drain to Source Voltage

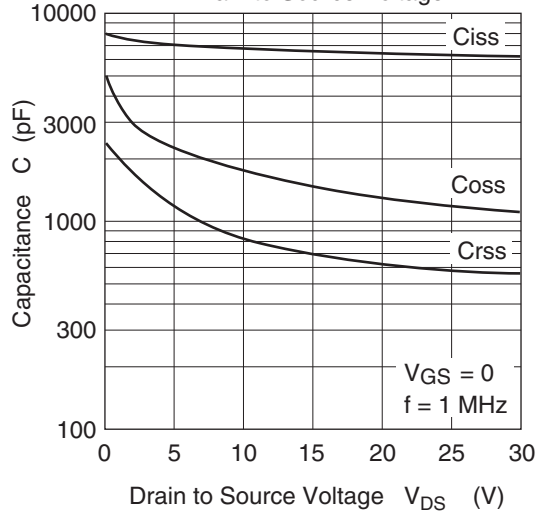

Dynamic Input Characteristics

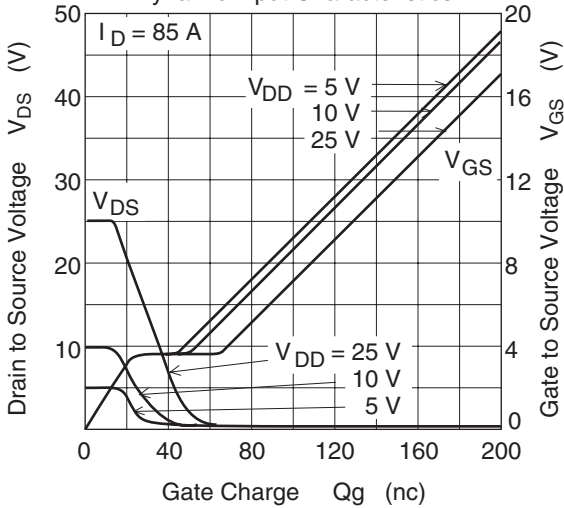

Switching Characteristics

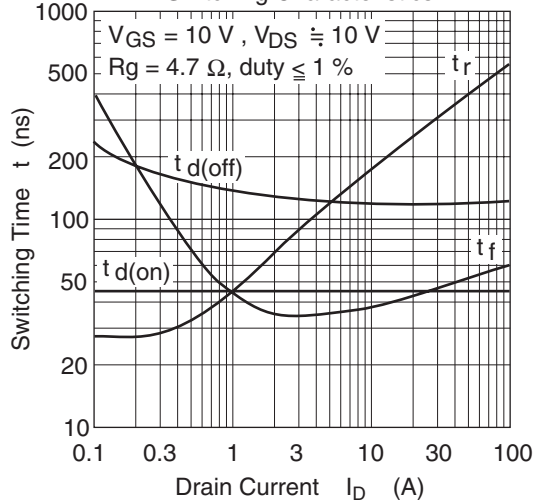

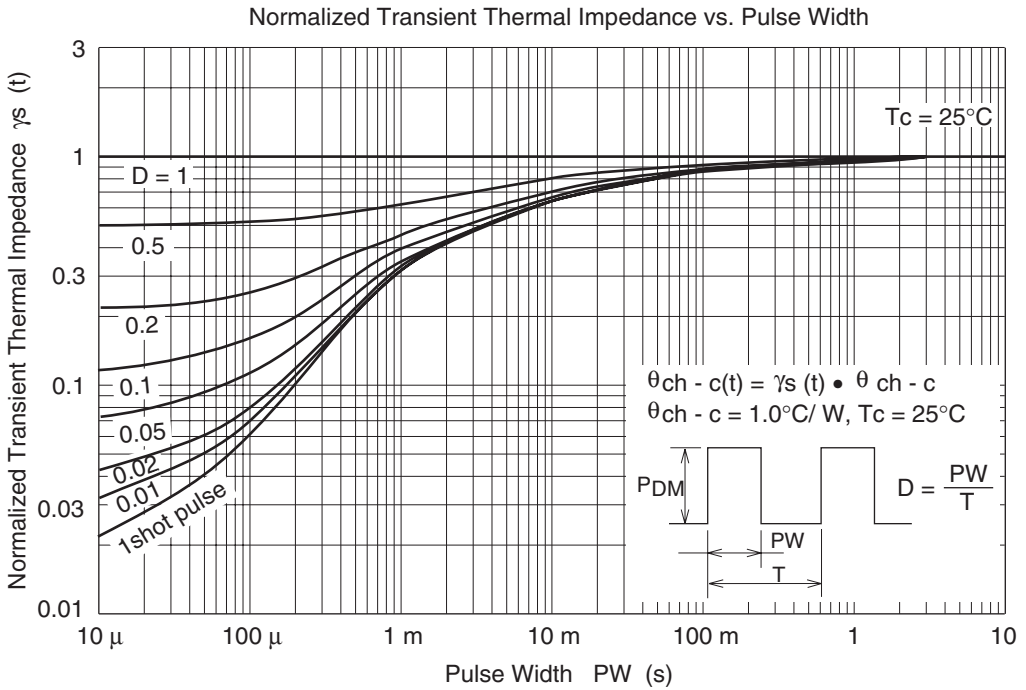
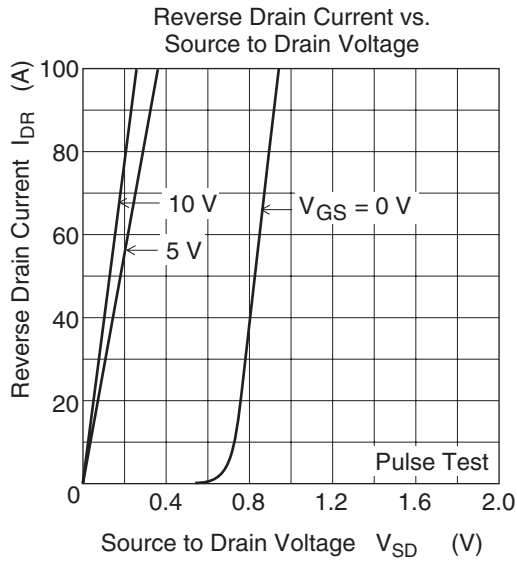

Package Dimensions

As of January, 2002
Unit: mm

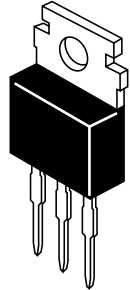
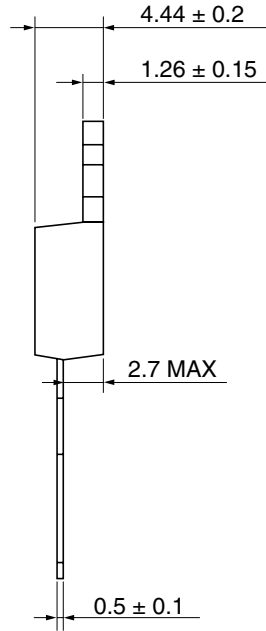
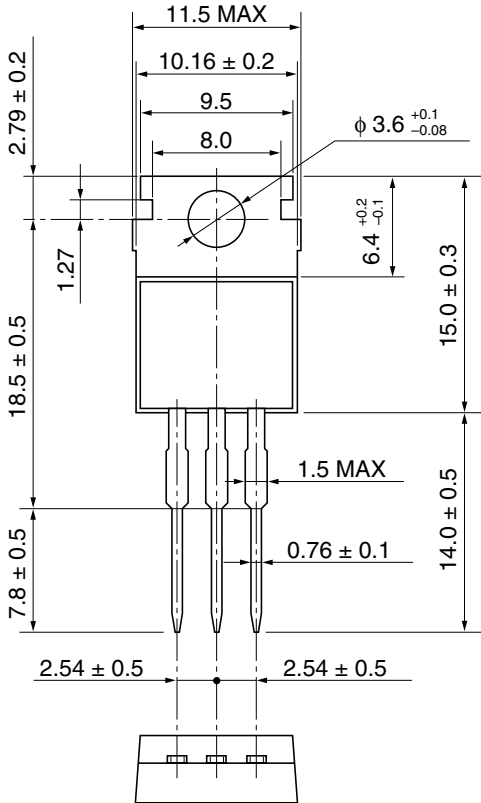

Hitachi Code	TO-220AB
JEDEC	Conforms
JEITA	Conforms
Mass (reference value)	1.8 g

Disclaimer

1. Hitachi neither warrants nor grants licenses of any rights of Hitachi's or any third party's patent, copyright, trademark, or other intellectual property rights for information contained in this document. Hitachi bears no responsibility for problems that may arise with third party's rights, including intellectual property rights, in connection with use of the information contained in this document.
2. Products and product specifications may be subject to change without notice. Confirm that you have received the latest product standards or specifications before final design, purchase or use.
3. Hitachi makes every attempt to ensure that its products are of high quality and reliability. However, contact Hitachi's sales office before using the product in an application that demands especially high quality and reliability or where its failure or malfunction may directly threaten human life or cause risk of bodily injury, such as aerospace, aeronautics, nuclear power, combustion control, transportation, traffic, safety equipment or medical equipment for life support.
4. Design your application so that the product is used within the ranges guaranteed by Hitachi particularly for maximum rating, operating supply voltage range, heat radiation characteristics, installation conditions and other characteristics. Hitachi bears no responsibility for failure or damage when used beyond the guaranteed ranges. Even within the guaranteed ranges, consider normally foreseeable failure rates or failure modes in semiconductor devices and employ systemic measures such as fail-safes, so that the equipment incorporating Hitachi product does not cause bodily injury, fire or other consequential damage due to operation of the Hitachi product.
5. This product is not designed to be radiation resistant.
6. No one is permitted to reproduce or duplicate, in any form, the whole or part of this document without written approval from Hitachi.
7. Contact Hitachi's sales office for any questions regarding this document or Hitachi semiconductor products.

Sales Offices

HITACHI

Hitachi, Ltd.

Semiconductor & Integrated Circuits
 Nippon Bldg., 2-6-2, Ohte-machi, Chiyoda-ku, Tokyo 100-0004, Japan
 Tel: <03> 3270-2111 Fax: <03> 3270-5109

URL <http://www.hitachisemiconductor.com/>

For further information write to:

Hitachi Semiconductor
 (America) Inc.
 179 East Tasman Drive
 San Jose, CA 95134
 Tel: <1> (408) 433-1990
 Fax: <1> (408) 433-0223

Hitachi Europe Ltd.
 Electronic Components Group
 Whitebrook Park
 Lower Cookham Road
 Maidenhead
 Berkshire SL6 8YA, United Kingdom
 Tel: <44> (1628) 585000
 Fax: <44> (1628) 778322

Hitachi Europe GmbH
 Electronic Components Group
 Dornacher Str 3
 D-85622 Feldkirchen
 Postfach 201, D-85619 Feldkirchen
 Germany
 Tel: <49> (89) 9 9180-0
 Fax: <49> (89) 9 29 30 00

Hitachi Asia Ltd.
 Hitachi Tower
 16 Collyer Quay #20-00
 Singapore 049318
 Tel: <65>-6538-6533/6538-8577
 Fax: <65>-6538-6933/6538-3877
 URL: <http://semiconductor.hitachi.com.sg>

Hitachi Asia Ltd.
 (Taipei Branch Office)
 4/F, No. 167, Tun Hwa North Road
 Hung-Kuo Building
 Taipei (105), Taiwan
 Tel: <886>-(2)-2718-3666
 Fax: <886>-(2)-2718-8180
 Telex: 23222 HAS-TP
 URL: <http://semiconductor.hitachi.com.tw>

Hitachi Asia (Hong Kong) Ltd.
 Group III (Electronic Components)
 7/F., North Tower
 World Finance Centre,
 Harbour City, Canton Road
 Tsim Sha Tsui, Kowloon Hong Kong
 Tel: <852>-2735-9218
 Fax: <852>-2730-0281
 URL: <http://semiconductor.hitachi.com.hk>

Copyright © Hitachi, Ltd., 2002. All rights reserved. Printed in Japan.

Colophon 7.0