

# Dual high slew rate, low noise operational amplifier

## BA15218 / BA15218F / BA15218N

The BA15218, BA15218F, and BA15218N are monolithic ICs with two built-in low-noise, low-distortion operational amplifiers featuring internal phase compensation.

Either a dual or single power supply can be driven, and these products can be driven by a digital system 5V single power supply.

The following packages are available: 8-pin DIP (BA15218), 8-pin SOP (BA15218F), and 8-pin SIP (BA15218N).

### ●Features

- 1) Low-voltage operation and single power supply drive enabled.  
(Single power supply: 4 to 32V, dual power supply:  $\pm 3$  to  $\pm 16$ V)
- 2) Low noise level. ( $V_n = 1.0\mu V_{rms}$  typ. : RIAA)
- 3) High slew rate. ( $SR = 3V / \mu s$ ,  $GBW = 10MHz$  typ.)
- 4) Low offset voltage. ( $V_{IO} = 0.5mV$  typ.)
- 5) High gain and low distortion. ( $G_{VO} = 110dB$ ,  $THD = 0.0015\%$ )
- 6) Pin connections are the same as with standard dual operational amplifiers, and outstanding characteristics make these products compatible with the 4558 and 4560 models.

### ●Block diagram

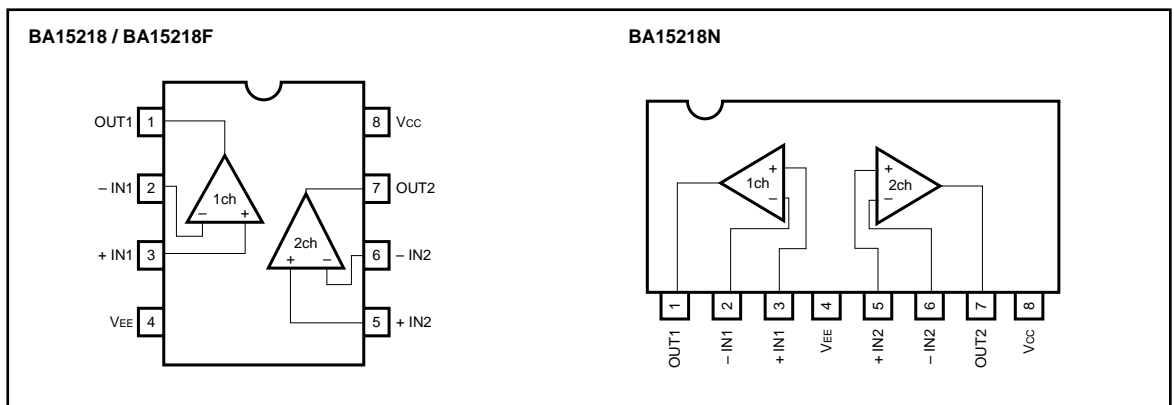

● Internal circuit configuration

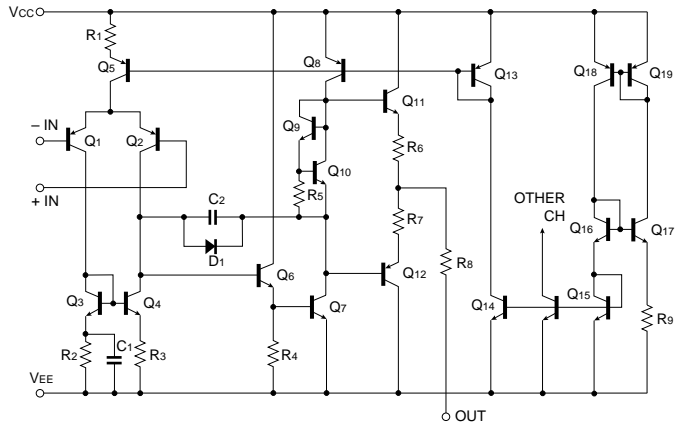

● Absolute maximum ratings (Ta = 25°C)

Parameter	Symbol	Limits			Unit
		BA15218	BA15218F	BA15218N	
Power supply voltage	V <sub>CC</sub>	± 18	± 18	± 18	V
Power dissipation	P <sub>d</sub>	800*	550*	900*	mW
Differential input voltage	V <sub>ID</sub>	± V <sub>CC</sub>	± V <sub>CC</sub>	± V <sub>CC</sub>	V
Common-mode input voltage	V <sub>I</sub>	- V <sub>CC</sub> ~ V <sub>CC</sub>	- V <sub>CC</sub> ~ V <sub>CC</sub>	- V <sub>CC</sub> ~ V <sub>CC</sub>	V
Load current	I <sub>OMAX</sub>	± 50	± 50	± 50	mA
Operating temperature	T <sub>opr</sub>	- 40 ~ + 85	- 40 ~ + 85	- 40 ~ + 85	°C
Storage temperature	T <sub>stg</sub>	- 55 ~ + 125	- 55 ~ + 125	- 55 ~ + 125	°C

\* Refer to P<sub>d</sub> characteristics diagram.

The values for the BA15218F are those when it is mounted on a glass epoxy board (50mm × 50mm × 1.6mm).

●Electrical characteristics (unless otherwise noted, Ta = 25°C, VCC = +15V, VEE = -15V)

Parameter	Symbol	Min.	Typ.	Max.	Unit	Conditions
Input offset voltage	V <sub>io</sub>	—	0.5	5	mV	R <sub>s</sub> ≤ 10kΩ
Input offset current	I <sub>io</sub>	—	5	200	nA	—
Input bias current	I <sub>b</sub>	—	50	500	nA	—
High-amplitude voltage gain	A <sub>v</sub>	86	110	—	dB	R <sub>L</sub> ≥ 2kΩ, V <sub>o</sub> = ± 10V
Common-mode input voltage	V <sub>icm</sub>	± 12	± 14	—	V	—
Maximum output voltage	V <sub>oH</sub>	± 12	± 14	—	V	R <sub>L</sub> ≥ 10kΩ
Maximum output voltage	V <sub>oL</sub>	± 10	± 13	—	V	R <sub>L</sub> ≥ 2kΩ
Common-mode rejection ratio	CMRR	70	90	—	dB	R <sub>s</sub> ≤ 10kΩ
Power supply voltage rejection ratio	PSRR	76	90	—	dB	R <sub>s</sub> ≤ 10kΩ
Quiescent current	I <sub>q</sub>	—	5	8	mA	V <sub>IN</sub> = 0V, R <sub>L</sub> = ∞
Slew rate	S.R.	—	3	—	V / μs	A <sub>v</sub> = 1, R <sub>L</sub> = 2kΩ
Channel separation	CS	—	120	—	dB	f = 1kHz input conversion
Voltage gain band width	GBW	—	10	—	MHz	f = 10kHz
Input conversion noise voltage	V <sub>n</sub>	—	1.0	—	μV <sub>rms</sub>	RIAA, R <sub>s</sub> = 1kΩ, 10Hz ~ 30kHz

●Electrical characteristic curves

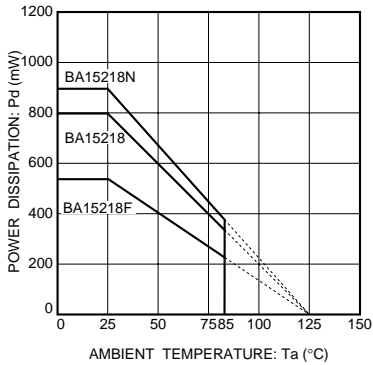

Fig.1 Power dissipation vs. ambient temperature

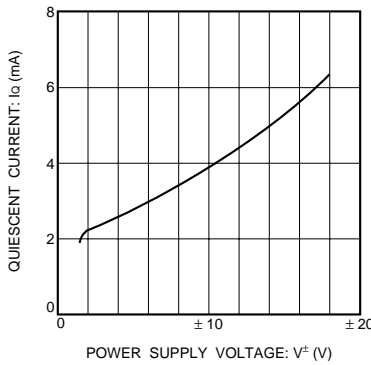

Fig.2 Quiescent current vs. power supply voltage

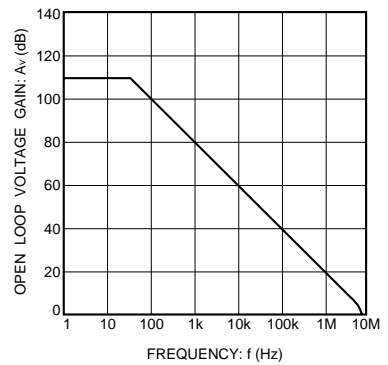

Fig.3 Open loop voltage gain vs. frequency

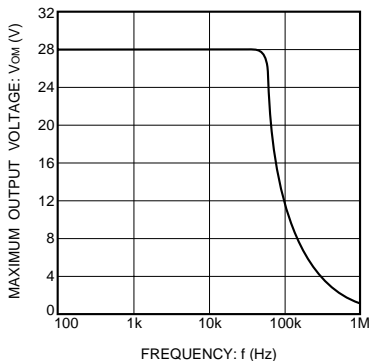

Fig.4 Maximum output voltage vs. frequency

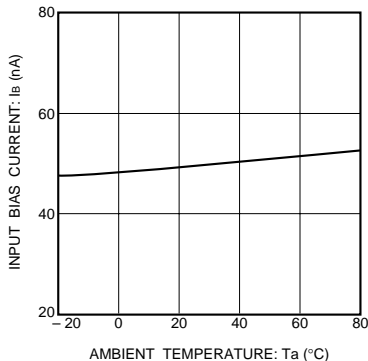

Fig.5 Input bias current vs. ambient temperature

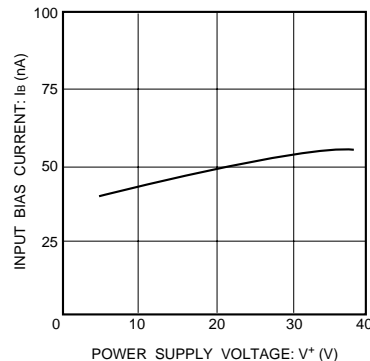

Fig.6 Input bias current vs. power supply voltage

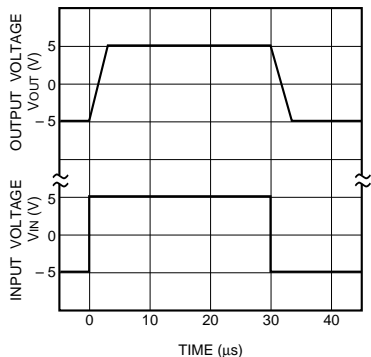

Fig.7 Output response characteristics

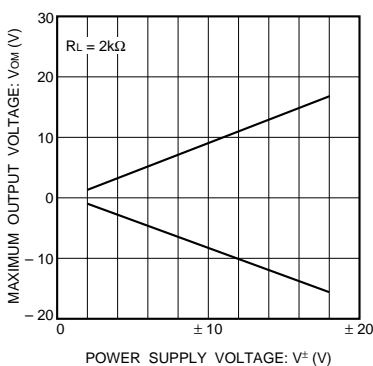

Fig.8 Maximum output voltage vs. power supply voltage

●Operation notes

(1) Unused circuit connections

If there are any circuits which are not being used, we recommend making connections as shown in Figure 9, with the non-inverted input pin connected to the potential within the in-phase input voltage range ( $V_{ICM}$ ).

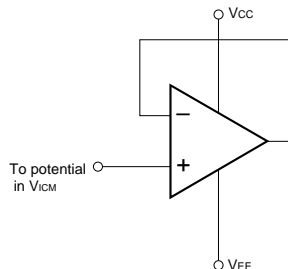

Fig.9 Unused circuit connections

● External dimensions (Units: mm)

