

Dual high slew rate, low noise operational amplifier

BA15532 / BA15532F / BA15532N

The BA15532, BA15532F, and BA15532N are low-noise dual operational amplifiers designed especially for applications involving high-grade audio equipment. Since they feature low noise, a wide band width, and high power output, these products can also be used in measuring instruments and control circuits. The following packages are available : 8-pin DIP (BA15532), 8-pin SOP (BA15532F), and 8-pin SIP (BA15532N).

●Features

- 1) High output current capacity.
- 2) High slew rate.
- 3) Low noise.

●Block diagram

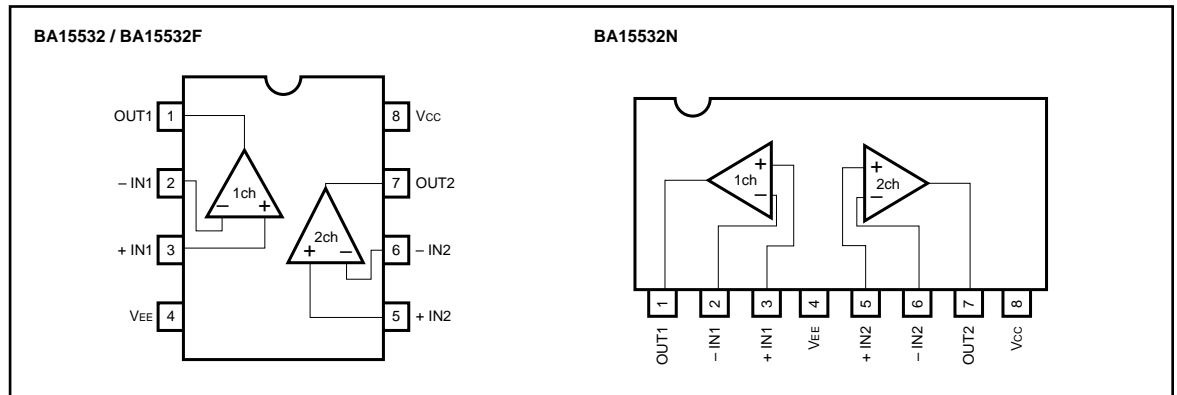

● Internal circuit configuration

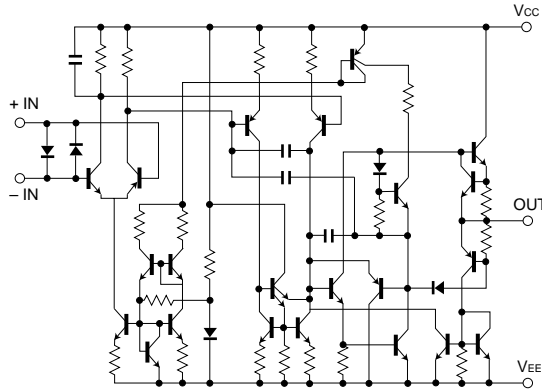

● Absolute maximum ratings (Ta = 25°C)

Parameter	Symbol	Limits			Unit
		BA15532	BA15532F	BA15532N	
Power supply voltage	V _{CC}	± 21	± 21	± 21	V
Power dissipation	P _d	800*	550*	900*	mW
Differential input voltage	V _{ID}	± 0.5	± 0.5	± 0.5	V
Common-mode input voltage	V _I	- V _{CC} ~ V _{CC}	- V _{CC} ~ V _{CC}	- V _{CC} ~ V _{CC}	V
Operating temperature	T _{opr}	- 20 ~ + 75	- 20 ~ + 75	- 20 ~ + 75	°C
Storage temperature	T _{stg}	- 55 ~ + 125	- 55 ~ + 125	- 55 ~ + 125	°C

* Refer to Pd characteristics diagram.

The values for the BA15532F are those when it is mounted on a glass epoxy board (50mm × 50mm × 1.6mm).

● Electrical characteristics (unless otherwise noted, Ta = 25°C, V_{CC} = + 15V, V_{EE} = - 15V)

Parameter	Symbol	Min.	Typ.	Max.	Unit	Conditions
Input offset voltage	V _{IO}	—	0.5	4	mV	R _S = 50Ω, R _L ≥ 10kΩ
Input offset current	I _{IO}	—	10	150	nA	R _L ≥ 10kΩ
Input bias current	I _B	—	200	800	nA	R _L ≥ 10kΩ
High-amplitude voltage gain	A _v	80	94	—	dB	R _L ≥ 600Ω, V _O = ± 10V
Common-mode input voltage	V _{ICM}	± 12	± 13	—	V	R _L ≥ 10kΩ
Maximum output voltage	V _{OM}	± 12	± 13	—	V	R _L ≥ 600Ω
Maximum output voltage	V _{OM}	± 15	± 16	—	V	R _L ≥ 600Ω, V _{CC} = 18V, V _{EE} = - 18V
Common-mode rejection ratio	CMRR	70	100	—	dB	R _L ≥ 10kΩ
Power supply voltage rejection ratio	PSRR	80	100	—	dB	R _S = 50Ω, R _L ≥ 10kΩ
Quiescent current	I _Q	—	8	16	mA	R _L = ∞, on All Op - Amps
Output short-circuit current	I _{OS}	—	38	—	mA	
Slew rate	S. R.	—	8	—	V / μs	A _v = 1, R _L = 600Ω, C _L = 100pF
Voltage gain band width	GBW	—	20	—	MHz	C _L = 100pF, R _L = 600Ω, f = 10kHz
Maximum frequency	f _r	—	7	—	MHz	
Input conversion noise voltage	V _n	—	0.7	1.5	μV	RIAA, R _S = 100Ω, BW = 20Hz ~ 30kHz
Channel separation	CS	—	110	—	dB	RIAA, f = 1kHz

● Electrical characteristic curves

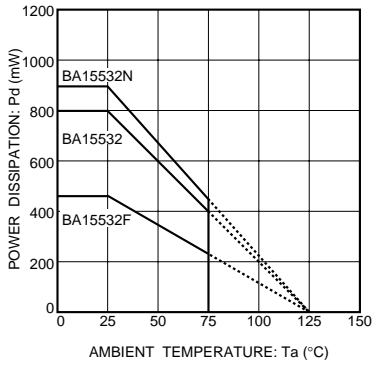

Fig.1 Power dissipation vs. ambient temperature

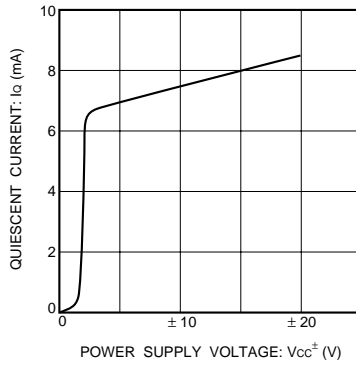

Fig.2 Quiescent current vs. power supply voltage

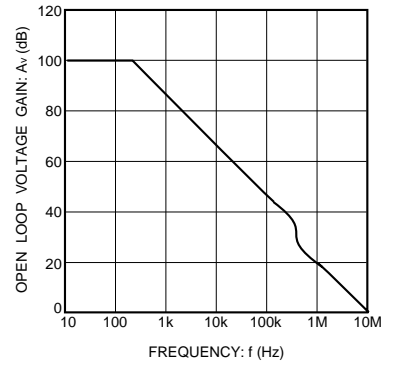

Fig.3 Open loop voltage gain vs. frequency

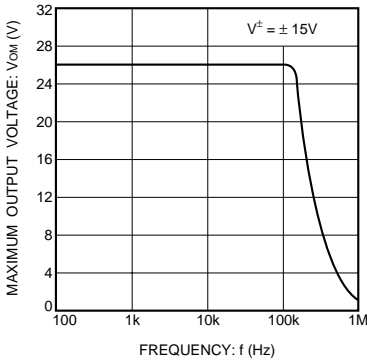

Fig.4 Maximum output voltage vs. frequency

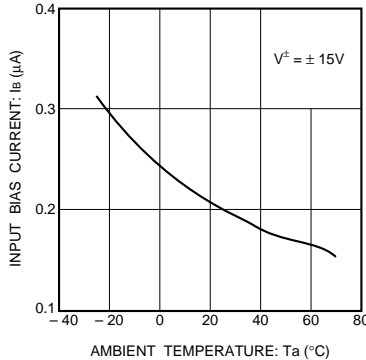

Fig.5 Input bias current vs. ambient temperature

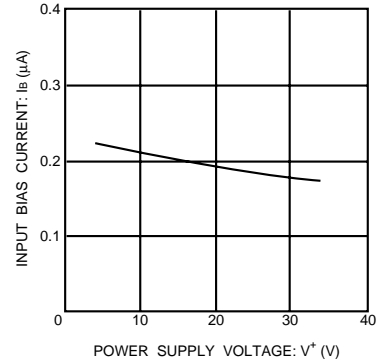

Fig.6 Input bias current vs. power supply voltage

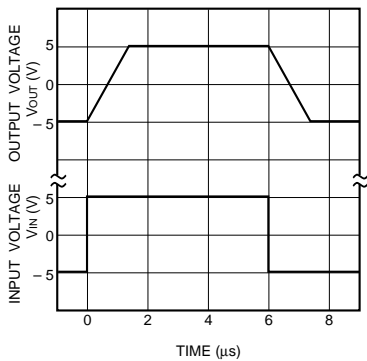

Fig.7 Output response characteristics

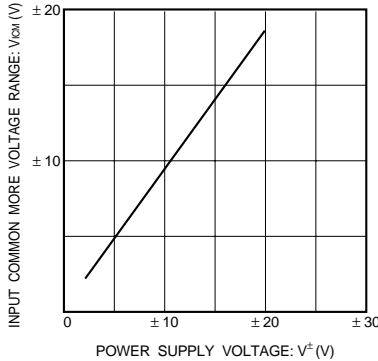

Fig.8 Common mode input voltage vs. power supply voltage

●Operation notes

(1) Handling unused circuits

If there are any circuits which are not being used, we recommend making connections as shown in Figure 9, with the non-inverted input pin connected to the potential within the in-phase input voltage range (V_{ICM}).

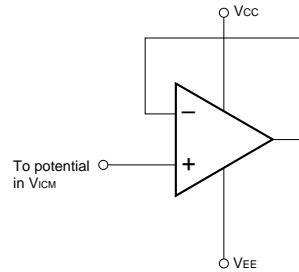

Fig.9 Unused circuit connections

●External dimensions (Units: mm)

