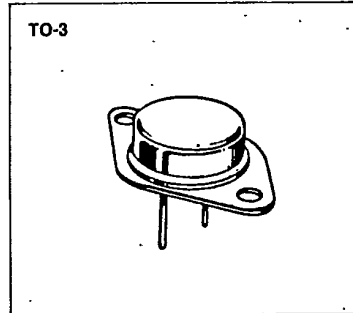
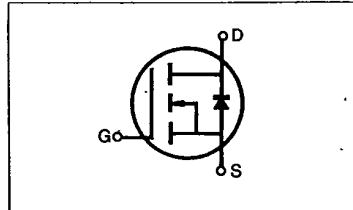

**N-CHANNEL
POWER MOSFETS****IRF130/131/132/133****FEATURES**

- Low $R_{DS(on)}$
- Improved inductive ruggedness
- Fast switching times
- Rugged polysilicon gate cell structure
- Low input capacitance
- Extended safe operating area
- Improved high temperature reliability
- TO-3 package (Standard)

**PRODUCT SUMMARY**

Part Number	V_{DS}	$R_{DS(on)}$	I_D
IRF130	100V	0.18 Ω	14A
IRF131	60V	0.18 Ω	14A
IRF132	100V	0.25 Ω	12A
IRF133	60V	0.25 Ω	12A

**MAXIMUM RATINGS**

Characteristic	Symbol	IRF130	IRF131	IRF132	IRF133	Unit
Drain-Source Voltage (1)	V_{DS}	100	60	100	60	Vdc
Drain-Gate Voltage ($R_{GS}=1.0M\Omega$) (1)	V_{DGR}	100	60	100	60	Vdc
Gate-Source Voltage	V_{GS}	± 20				Vdc
Continuous Drain Current $T_C=25^\circ C$	I_D	14	14	12	12	Adc
Continuous Drain Current $T_C=100^\circ C$	I_D	9.0	9.0	8.0	8.0	Adc
Drain Current—Pulsed (3)	I_{DM}	56	56	48	48	Adc
Gate Current—Pulsed	I_{GM}	± 1.5				Adc
Total Power Dissipation @ $T_C=25^\circ C$ Derate above $25^\circ C$	P_D	75 0.6				Watts W/ $^\circ C$
Operating and Storage Junction Temperature Range	T_J, T_{stg}	-55 to 150				$^\circ C$
Maximum Lead Temp. for Soldering Purposes, 1/8" from case for 5 seconds	T_L	300				$^\circ C$

Notes: (1) $T_J=25^\circ C$ to $150^\circ C$

(2) Pulse test: Pulse width $\leq 300\mu s$, Duty Cycle $\leq 2\%$

(3) Repetitive rating: Pulse width limited by max. junction temperature

IRF130/131/132/133

N-CHANNEL
POWER MOSFETSELECTRICAL CHARACTERISTICS (T_C=25°C unless otherwise specified)

Characteristic	Symbol	Type	Min	Typ	Max	Units	Test Conditions
Drain-Source Breakdown Voltage	BV _{DSS}	IRF130 IRF132	100	—	—	V	V _{GS} =0V
		IRF131 IRF133	60	—	—	V	I _D =250μA
Gate Threshold Voltage	V _{GS(th)}	ALL	2.0	—	4.0	V	V _{DS} =V _{GS} , I _D =250μA
Gate-Source Leakage Forward	I _{GSS}	ALL	—	—	100	nA	V _{GS} =20V
Gate-Source Leakage Reverse	I _{GSS}	ALL	—	—	-100	nA	V _{GS} =-20V
Zero Gate Voltage Drain Current	I _{DSS}	ALL	—	—	250	μA	V _{DS} =Max. Rating, V _{GS} =0V
		—	—	—	1000	μA	V _{DS} =Max. Rating×0.8, V _{GS} =0V, T _C =125°C
On-State Drain-Source Current (2)	I _{D(on)}	IRF130 IRF131	14	—	—	A	V _{DS} >I _{D(on)} ×R _{DS(on) max.} , V _{GS} =10V
		IRF132 IRF133	12	—	—	A	
Static Drain-Source On-State Resistance (2)	R _{DS(on)}	IRF130 IRF131	—	0.10	0.18	Ω	V _{GS} =10V, I _D =8.0A
		IRF132 IRF133	—	0.20	0.25	Ω	
Forward Transconductance (2)	g _{fs}	ALL	4.0	5.5	—	S	V _{DS} >I _{D(on)} ×R _{DS(on) max.} , I _D =8.0A
Input Capacitance	C _{iss}	ALL	—	680	800	pF	V _{GS} =0V, V _{DS} =25V, f=1.0MHz
Output Capacitance	C _{oss}	ALL	—	300	500	pF	
Reverse Transfer Capacitance	C _{ras}	ALL	—	100	150	pF	
Turn-On Delay Time	t _{d(on)}	ALL	—	—	30	ns	V _{DD} =0.5BV _{DSS} , I _D =8.0A, Z _O =15 Ω (MOSFET switching times are essentially independent of operating temperature.)
Rise Time	t _r	ALL	—	—	75	ns	
Turn-Off Delay Time	t _{d(off)}	ALL	—	—	40	ns	
Fall Time	t _f	ALL	—	—	45	ns	
Total Gate Charge (Gate-Source Plus Gate-Drain)	Q _g	ALL	—	18	30	nC	V _{GS} =10V, I _D =18A, V _{DS} =0.8 Max. Rating (Gate charge is essentially independent of operating temperature.)
Gate-Source Charge	Q _{gs}	ALL	—	6.0	—	nC	
Gate-Drain ("Miller") Charge	Q _{gd}	ALL	—	12.0	—	nC	

THERMAL RESISTANCE

Junction-to-Case	R _{thJC}	ALL	—	—	1.67	K/W	
Case-to-Sink	R _{thCS}	ALL	—	0.1	—	K/W	Mounting surface flat, smooth, and greased
Junction-to-Ambient	R _{thJA}	ALL	—	—	30	K/W	Free Air Operation

Notes: (1) T_J=25°C to 150°C

(2) Pulse test: Pulse width≤300μs, Duty Cycle≤2%

(3) Repetitive rating: Pulse width limited by max. junction temperature

IRF130/131/132/133

**N-CHANNEL
POWER MOSFETS**

SOURCE-DRAIN DIODE RATINGS AND CHARACTERISTICS

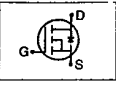
Characteristic	Symbol	Type	Min	Typ	Max	Units	Test Conditions
Continuous Source Current (Body Diode)	I _S	IRF130 IRF131	—	—	14	A	Modified MOSFET symbol showing the integral reverse P-N junction rectifier 
		IRF132 IRF133	—	—	12	A	
		IRF130 IRF131	—	—	56	A	
Pulse Source Current (Body Diode) (3)	I _{SM}	IRF130 IRF131	—	—	56	A	
		IRF132 IRF133	—	—	48	A	
		IRF130 IRF131	—	—	2.5	V	
Diode Forward Voltage (2)	V _{SD}	IRF130 IRF131	—	—	2.5	V	T _C =25°C, I _S =12A, V _{GS} =0V
		IRF132 IRF133	—	—	2.3	V	
Reverse Recovery Time	t _{rr}	ALL	—	360	—	ns	T _J =150°C, I _F =14A, dI _F /dt=100A/μs

Notes: (1) T_J=25°C to 150°C (2) Pulse test: Pulse width ≤ 300μs, Duty Cycle ≤ 2%
(3) Repetitive rating: Pulse width limited by max. junction temperature

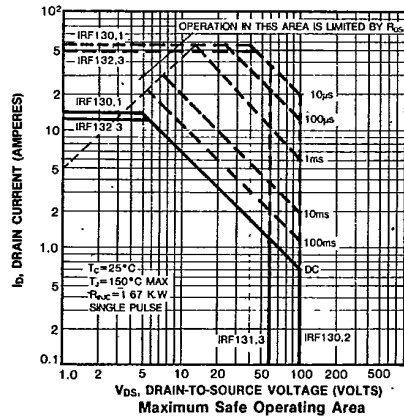
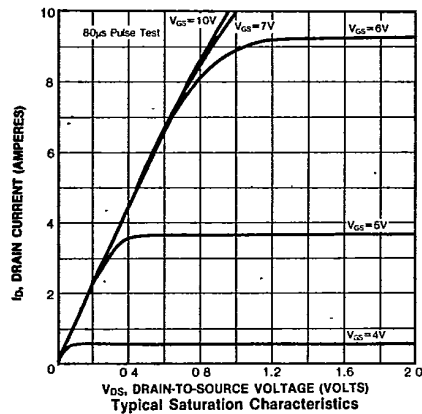
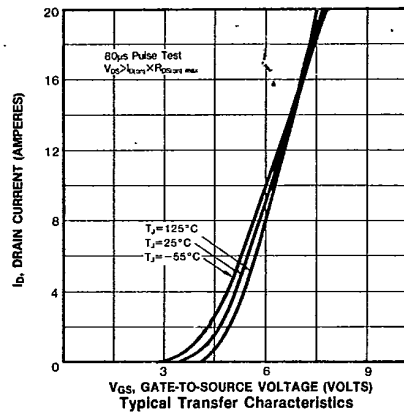
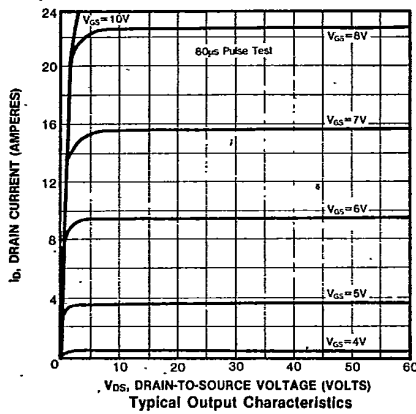

IRF130/131/132/133

N-CHANNEL
POWER MOSFETS

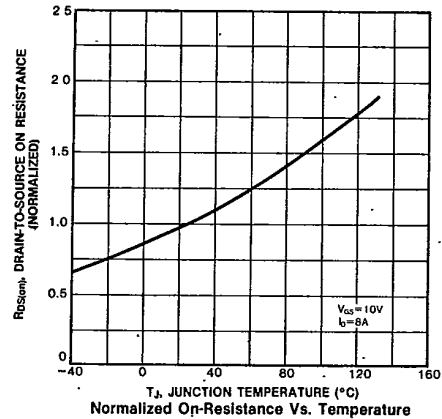
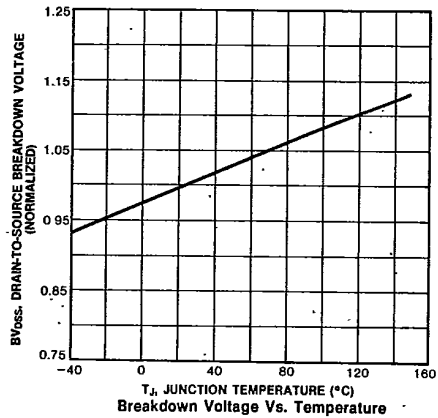
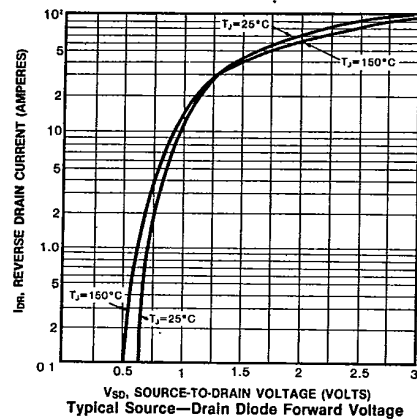
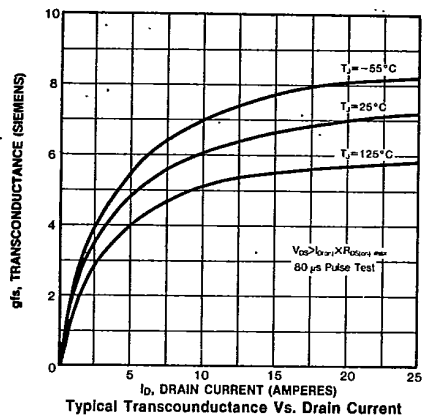
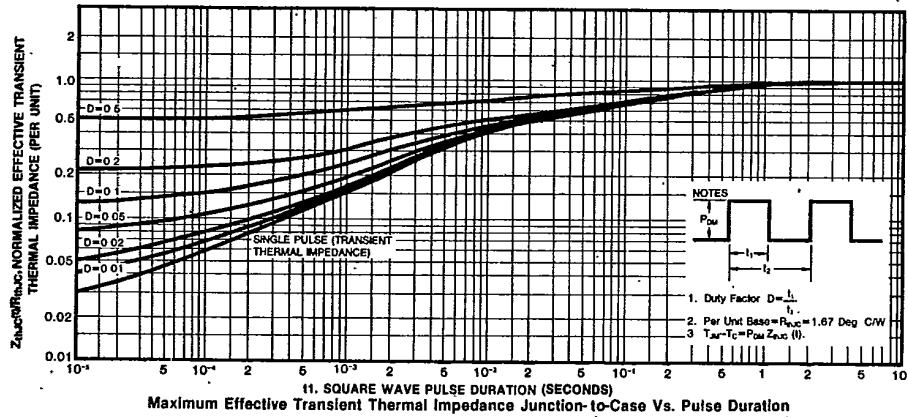

IRF130/131/132/133

**N-CHANNEL
POWER MOSFETS**

