

Absolute maximum ratings

($T_a=25^\circ\text{C}$)

Symbol	Ratings	Unit
V_{CB0}	60	V
V_{CEO}	60	V
V_{EBO}	6	V
I_c	4	A
I_{cP}	6 ($PW \leq 1\text{ms}$, $D_u \leq 50\%$)	A
I_B	0.5	A
P_T	2.6 ($T_a=25^\circ\text{C}$)	W
T_j	150	$^\circ\text{C}$
T_{stg}	-40 to +150	$^\circ\text{C}$

Electrical characteristics

($T_a=25^\circ\text{C}$)

Symbol	Specification			Unit	Conditions
	min	typ	max		
I_{CBO}			10	μA	$V_{CB}=60\text{V}$
I_{EBO}			10	mA	$V_{EB}=6\text{V}$
V_{CEO}	60			V	$I_c=10\text{mA}$
h_{FE}	2000		12000		$V_{CE}=4\text{V}$, $I_c=3\text{A}$
$V_{CE(sat)}$			1.5	V	$I_c=3\text{A}$, $I_B=6\text{mA}$
$V_{BE(sat)}$			2.0	V	
V_{FEC}			1.8	V	$I_{FEC}=1\text{A}$
t_{on}		1.0		μs	$V_{CC} \doteq 30\text{V}$,
t_{stg}		4.0		μs	$I_c=3\text{A}$,
t_f		1.5		μs	$I_{B1}=-I_{B2}=10\text{mA}$
f_T		75		MHz	$V_{CE}=12\text{V}$, $I_E=-0.1\text{A}$
C_{ob}		50		pF	$V_{CB}=10\text{V}$, $f=1\text{MHz}$

Equivalent circuit diagram

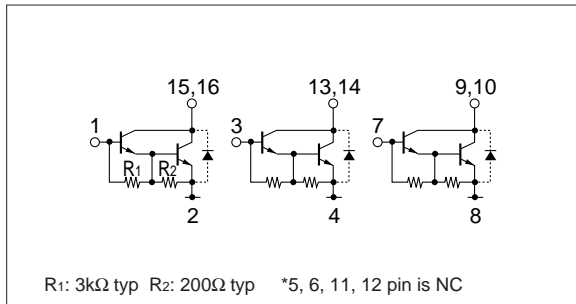

Characteristic curves

I_c - V_{CE} Characteristics (Typical)

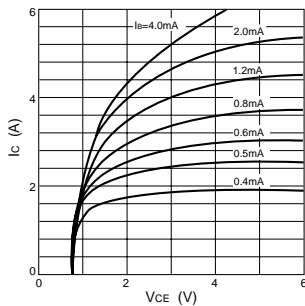

h_{FE} - I_c Characteristics (Typical)

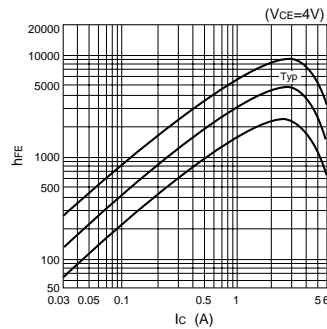

h_{FE} - I_c Temperature Characteristics (Typical)

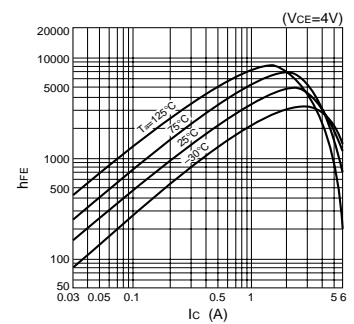

$V_{CE(sat)}$ - I_c Temperature Characteristics (Typical)

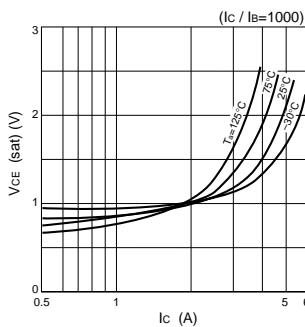

$V_{CE(sat)}$ - I_B Characteristics (Typical)

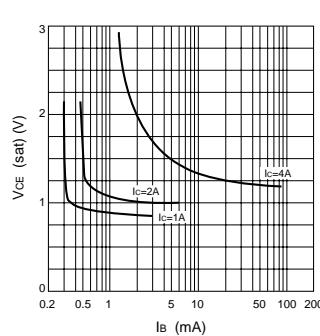

I_c - V_{BE} Temperature Characteristics (Typical)

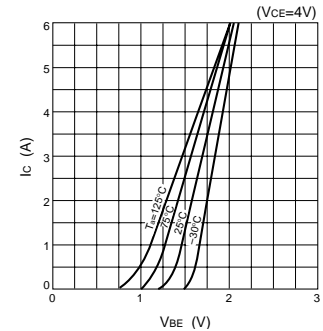

θ_{j-a} -PW Characteristics

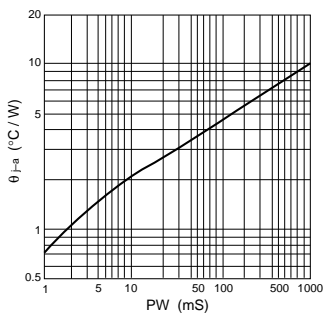

P_T - T_a Characteristics

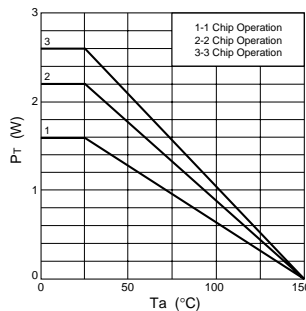

Safe Operating Area (SOA)

