



No.2210B

2SB1224/2SD1826

PNP/NPN Epitaxial Planar Silicon Darlington Transistor

Driver Applications

Applications

- Suitable for use in control of motor drivers, printer hammer drivers, relay drivers, and constant-voltage regulators.

Features

- High DC current gain.
- Large current capacity and wide ASO.
- Micaless package facilitating mounting.

() : 2SB1224

Absolute Maximum Ratings at $T_a = 25^\circ\text{C}$

			unit
Collector-to-Base Voltage	V_{CB0}	(-)70	V
Collector-to-Emitter Voltage	V_{CEO}	(-)60	V
Emitter-to-Base Voltage	V_{EBO}	(-)6	V
Collector Current	I_C	(-)7	A
Collector Current (Pulse)	I_{CP}	(-)10	A
Collector Dissipation	P_C	2.0	W
		25	W
		150	$^\circ\text{C}$
Junction Temperature	T_j		
Storage Temperature	T_{stg}	-55 to +150	$^\circ\text{C}$

 $T_c = 25^\circ\text{C}$ **Electrical Characteristics at $T_a = 25^\circ\text{C}$**

			min	typ	max	unit
Collector Cutoff Current	I_{CBO}	$V_{CB} = (-)40\text{V}, I_E = 0$			(-)0.1	mA
Emitter Cutoff Current	I_{EBO}	$V_{EB} = (-)5\text{V}, I_C = 0$			(-)3.0	mA
DC Current Gain	h_{FE}	$V_{CE} = (-)2\text{V}, I_C = (-)3.5\text{A}$	2000	5000		
Gain-Bandwidth Product	f_T	$V_{CE} = (-)5\text{V}, I_C = (-)3.5\text{A}$		20		MHz
C-E Saturation Voltage	$V_{CE(sat)}$	$I_C = (-)3.5\text{A}, I_B = (-)7\text{mA}$		0.9	(-)1.5	V
				(-1.0)		V
B-E Saturation Voltage	$V_{BE(sat)}$	$I_C = (-)3.5\text{A}, I_B = (-)7\text{mA}$			(-)2.0	V
C-B Breakdown Voltage	$V_{(BR)CBO}$	$I_C = (-)5\text{mA}, I_E = 0$	(-)70			V
C-E Breakdown Voltage	$V_{(BR)CEO}$	$I_C = (-)50\text{mA}, R_{BE} = \infty$	(-)60			V
Turn-ON Time	t_{on}	See specified Test Circuit.		0.6		μs
		"		(0.5)		μs
Storage Time	t_{stg}	"		3.0		μs
		"		(1.5)		μs
Fall Time	t_f	"		1.7		μs
		"		(1.4)		μs

Package Dimensions 2041A

(unit: mm)

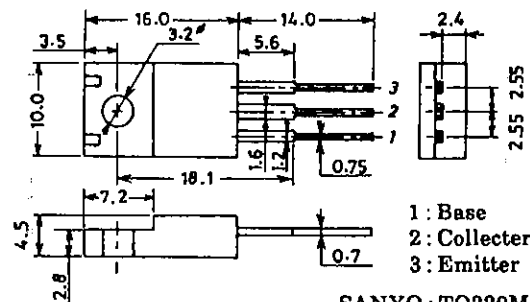

SANYO: TO220ML

SANYO Electric Co., Ltd. Semiconductor Business Headquarters

TOKYO OFFICE Tokyo Bldg., 1-10, 1 Chome, Ueno, Taito-ku, TOKYO, 110 JAPAN

Specified Test Circuit (For PNP, the polarity is reversed.)

PW = 50μs, Duty cycle ≤ 1%

500I_{B1} = -500I_{B2} = I_C = 3A

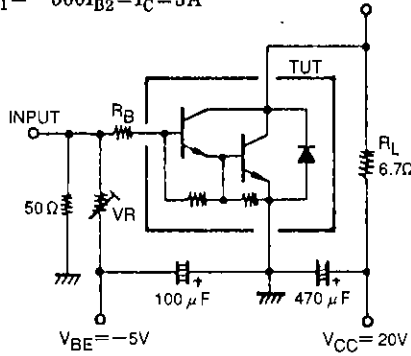

Electrical Connection

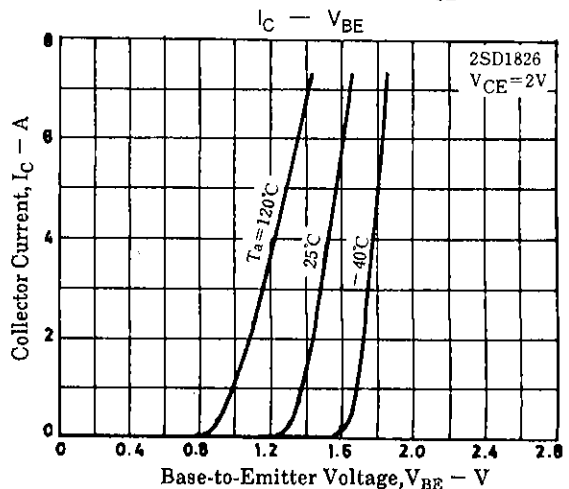
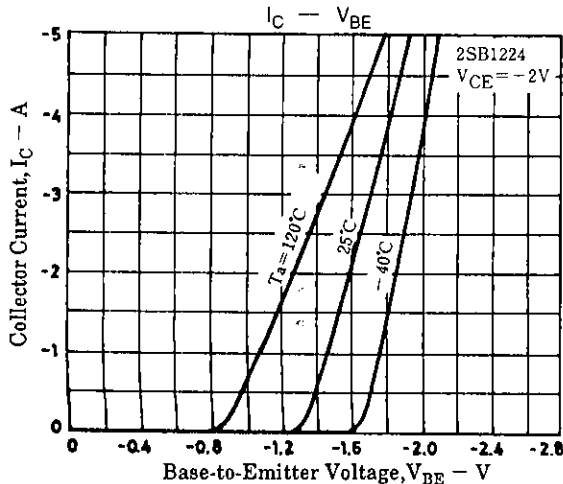
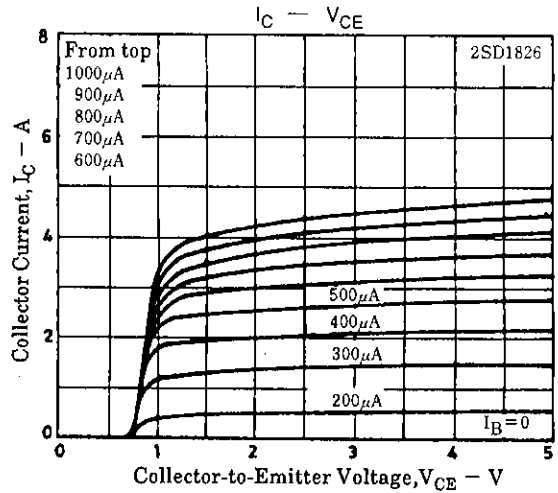
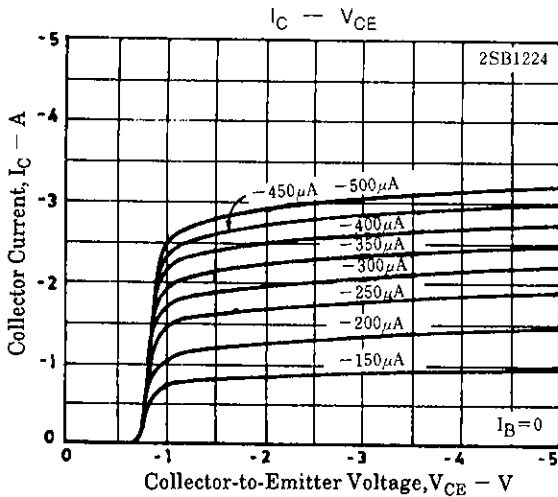
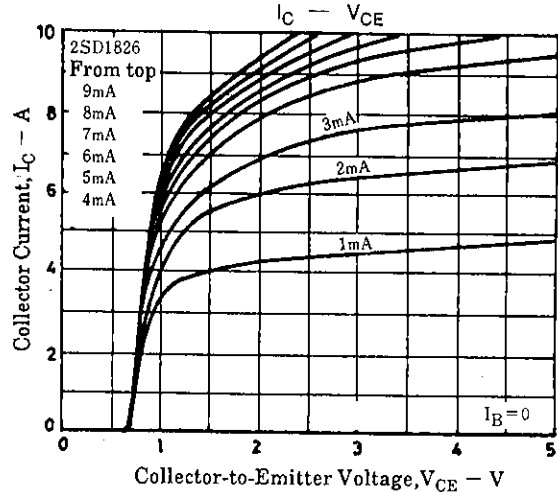
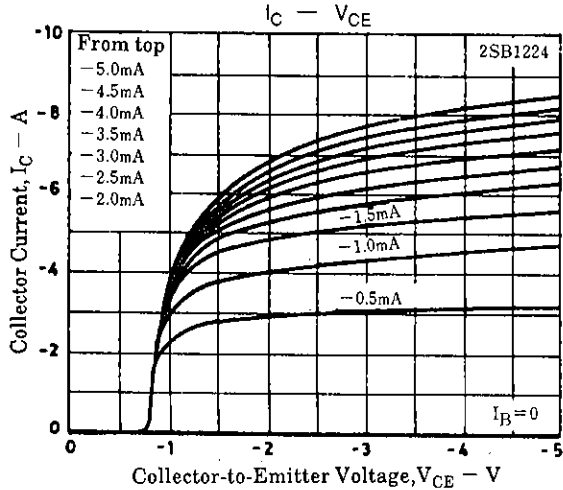
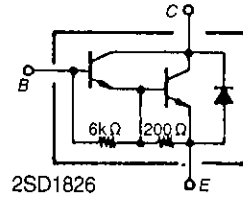
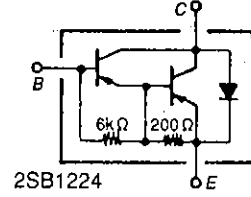

2SB1224/2SD1826

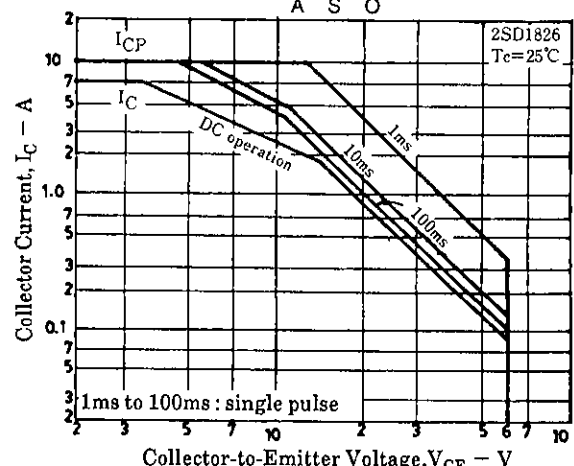
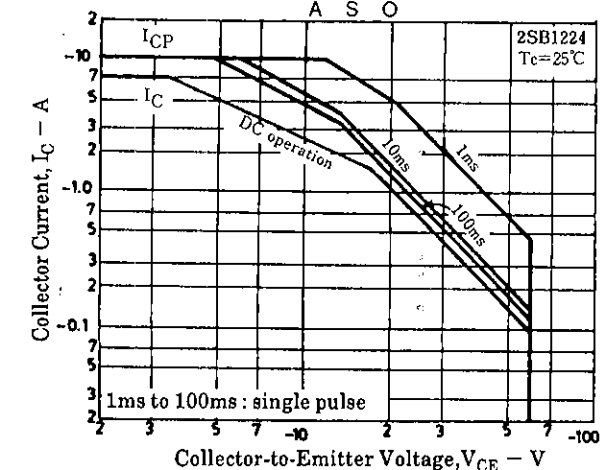
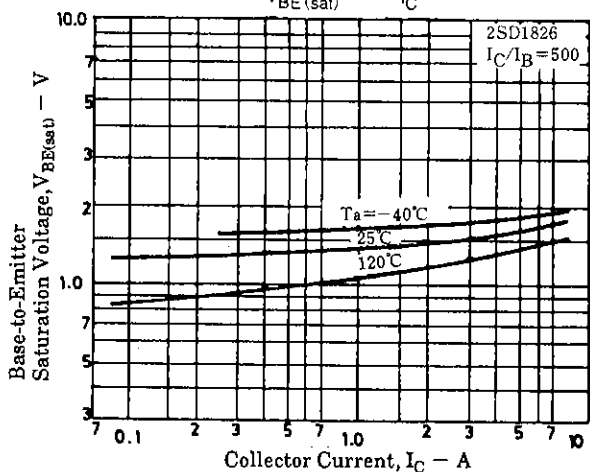
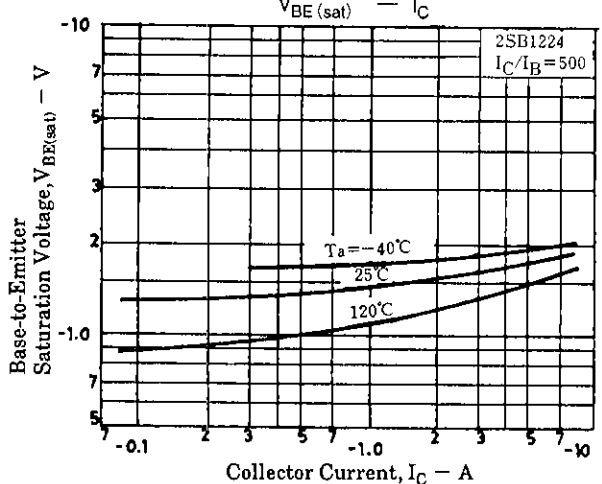
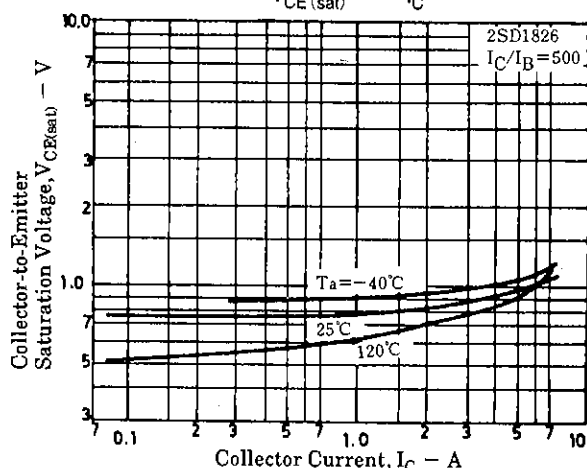
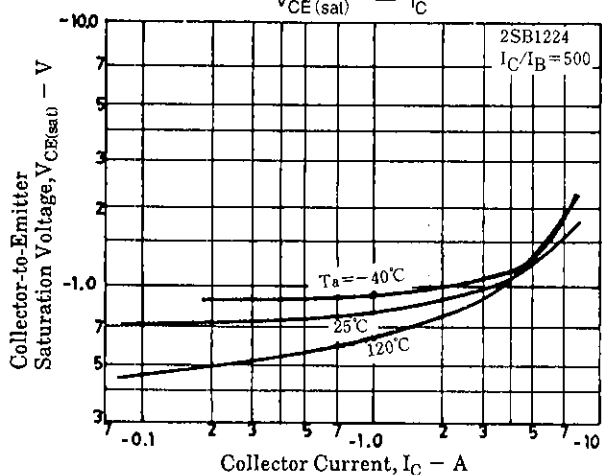
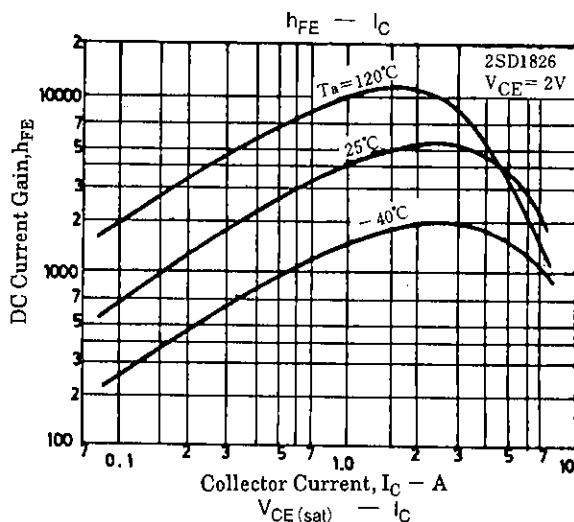
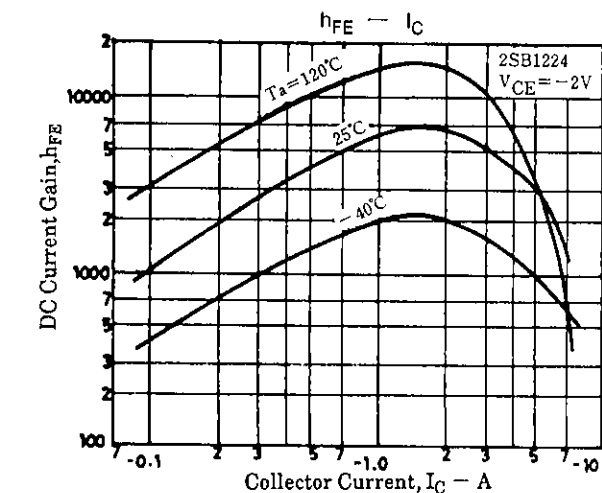

2SB1224/2SD1826

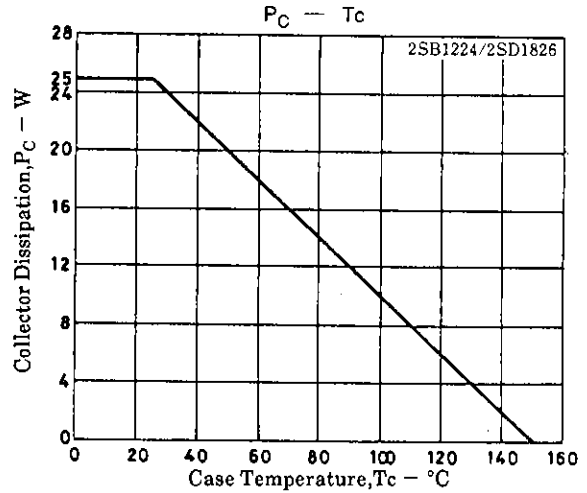
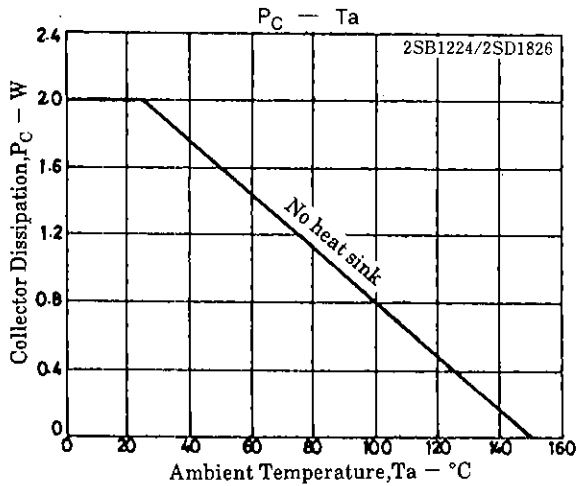

- No products described or contained herein are intended for use in surgical implants, life-support systems, aerospace equipment, nuclear power control systems, vehicles, disaster/crime-prevention equipment and the like, the failure of which may directly or indirectly cause injury, death or property loss.
- Anyone purchasing any products described or contained herein for an above-mentioned use shall:
 - ① Accept full responsibility and indemnify and defend SANYO ELECTRIC CO., LTD., its affiliates, subsidiaries and distributors and all their officers and employees, jointly and severally, against any and all claims and litigation and all damages, cost and expenses associated with such use;
 - ② Not impose any responsibility for any fault or negligence which may be cited in any such claim or litigation on SANYO ELECTRIC CO., LTD., its affiliates, subsidiaries and distributors or any of their officers and employees jointly or severally.
- Information (including circuit diagrams and circuit parameters) herein is for example only; it is not guaranteed for volume production. SANYO believes information herein is accurate and reliable, but no guarantees are made or implied regarding its use or any infringements of intellectual property rights or other rights of third parties.

This catalog provides information as of August, 1996. Specifications and information herein are subject to change without notice.