

SANYO**LA6324N, 6324NM****High-Performance
Quad Operational Amplifier****Overview**

The LA6324 consists of four independent, high-performance, internally phase compensated operational amplifiers that are designed to operate from a single power supply over a wide range of voltages. These four operational amplifiers are packaged in a single package. As in case of conventional general-purpose operational amplifiers, operation from dual power supplies is also possible and the power dissipation is low. It can be applied to various uses in commercial and industrial equipment including all types of transducer amplifiers and DC amplifiers.

Features

- No phase compensation required
- Wide operating voltage range:
 - 3.0 V to 30.0 V (single supply)
 - ± 1.5 V to ± 15.0 V (dual supplies)
- Highly resistant to dielectric breakdown
- Input voltage range includes the neighborhood of GND level and output voltage range V_{OUT} is from 0 to $V_{CC} - 1.5$ V.
- Small current dissipation:
 - $I_{CC} = 0.6$ mA typ/ $V_{CC} = +5$ V, $R_L = \infty$

Package Dimensions

unit : mm

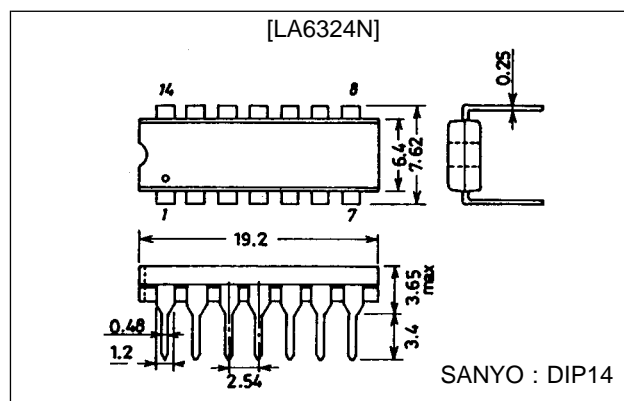
3003A-DIP14

unit : mm

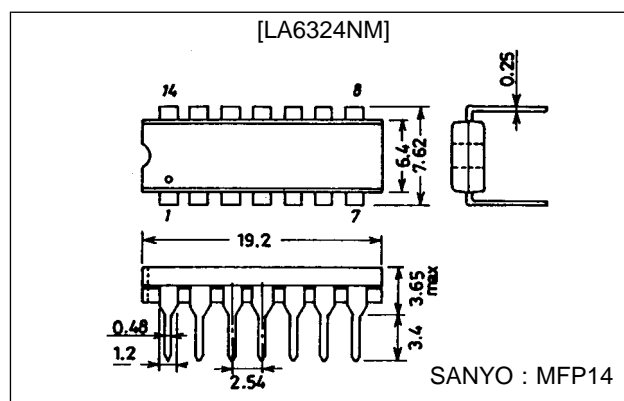
3034A-MFP14**Specifications****Maximum Ratings at $T_a = 25^\circ\text{C}$**

Parameter	Symbol	Conditions	Ratings	Unit
Maximum supply voltage	V_{CC} max		32	V
Differential input voltage	V_{ID}		32	V
Maximum input voltage	V_{IN} max		-0.3 to +32	V
Allowable power dissipation	P_d max	LA6324N	720	mW
		LA6324NM	330	mW
Operating temperature	T_{opr}		-30 to +85	$^\circ\text{C}$
Storage temperature	T_{stg}		-55 to +125	$^\circ\text{C}$

SANYO Electric Co.,Ltd. Semiconductor Business Headquarters

TOKYO OFFICE Tokyo Bldg., 1-10, 1 Chome, Ueno, Taito-ku, TOKYO, 110 JAPAN

63096HA(II)/4138TA(KOTO) No.2704-1/5

LA6324N, 6324NM

Operating Characteristics at $T_a = 25^\circ\text{C}$, $V_{CC} = +5\text{ V}$

Parameter	Symbol	Conditions	Test circuit	min	typ	max	Unit
Input offset voltage	V_{IO}		1		± 2	± 7	mV
Input offset current	I_{IO}	$I_{IN(+)} / I_{IN(-)}$	2		± 5	± 50	nA
Input bias current	I_B	$I_{IN(+)} / I_{IN(-)}$	3		45	250	nA
Common-mode input voltage range	V_{ICM}		4	0		$V_{CC} - 1.5$	V
Common-mode rejection ratio	CMR		4	65	80		dB
Voltage gain	VG	$V_{CC} = 15\text{ V}$, $R_L \geq 2\text{ k}\Omega$	5	25	100		V/mV
Output voltage range	V_{OUT}			0		$V_{CC} - 1.5$	V
Supply voltage rejection ratio	SVR		6	65	100		dB
Channel separation	CS	$f = 1\text{ k}$ to 20 kHz	7		120		dB
Current drain	I_{CC}		8		0.6	2	mA
	I_{CC}	$V_{CC} = 30\text{ V}$	8		1.5	3	mA
Output current (Source)	I_O source	$V_{IN+} = 1\text{ V}$, $V_{IN-} = 0\text{ V}$	9	20	40		mA
Output current (Sink)	I_O sink	$V_{IN+} = 0\text{ V}$, $V_{IN-} = 1\text{ V}$	10	10	20		mA

Equivalent Circuit

(1 unit)

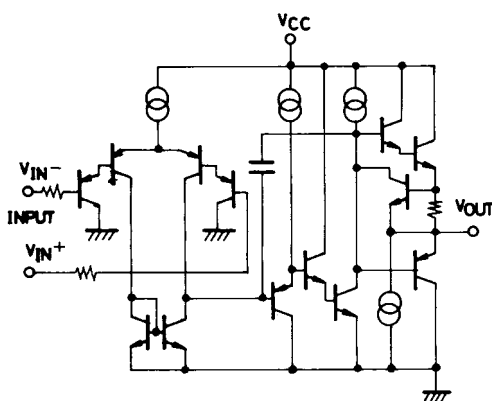

Pin Assignment

(LA6324N, 6324NM)

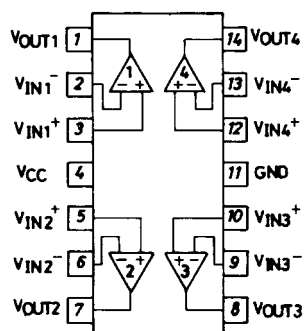

Top view

Test Circuit

1. Input offset voltage V_{IO}

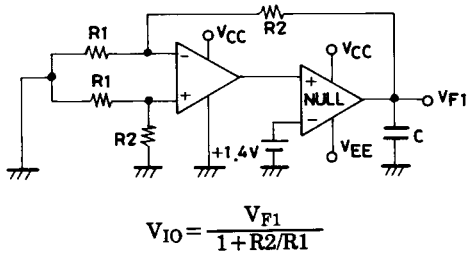

2. Input offset current I_{IO}

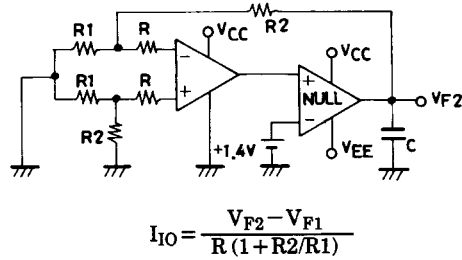

3. Input bias current I_B

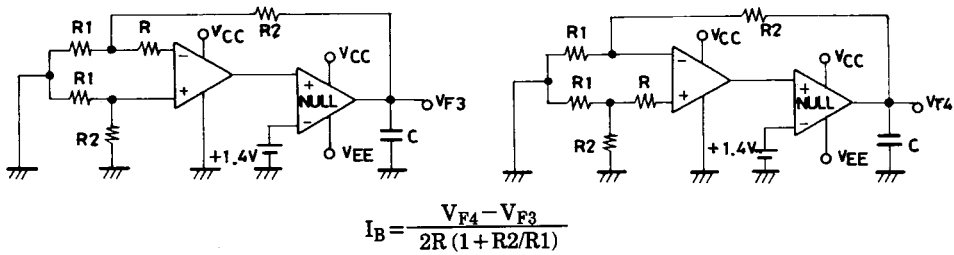

4. Common-mode rejection ratio CMR
Common-mode input voltage range V_{ICM}

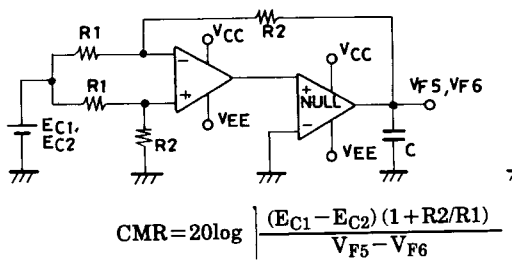

5. Voltage gain V_G

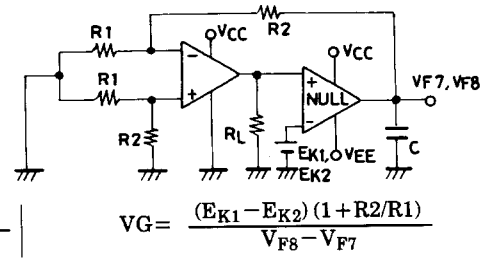

6. Supply voltage rejection ratio SVR

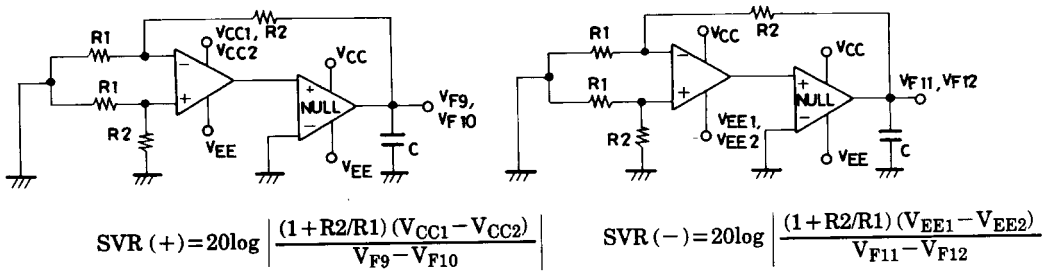

7. Channel separation CS

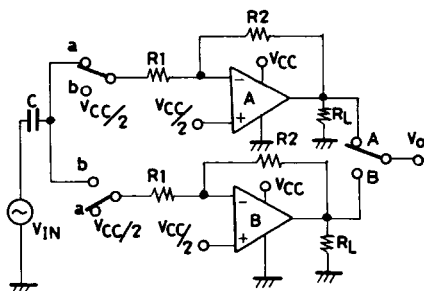

SW: a

$$CS(A \rightarrow B) = 20 \log \frac{R2 V_{OA}}{R1 V_{OB}}$$

SW: b

$$CS(B \rightarrow A) = 20 \log \frac{R2 V_{OB}}{R1 V_{OA}}$$

These apply also to other channels.

LA6324N, 6324NM

8. Current drain I_{CC}

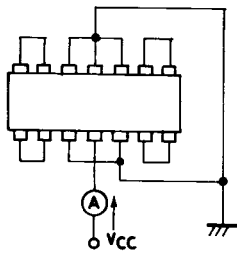

9. Output current I_O source

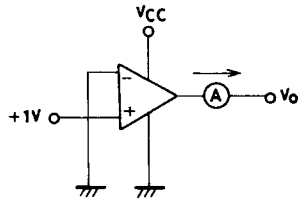

10. Output current I_O sink

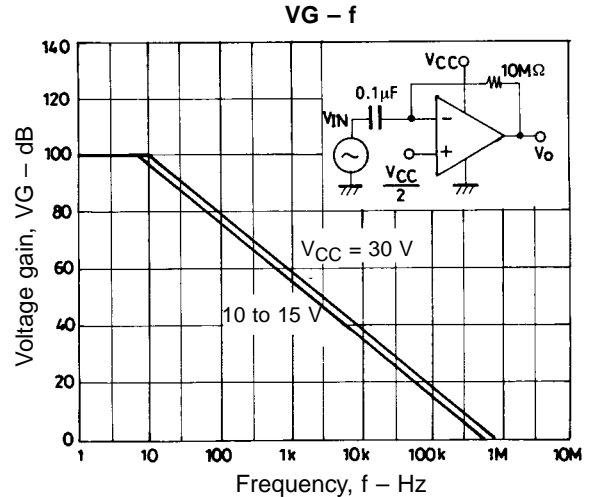
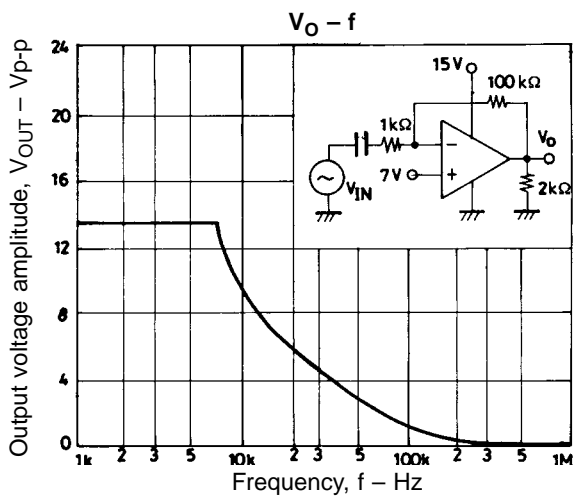
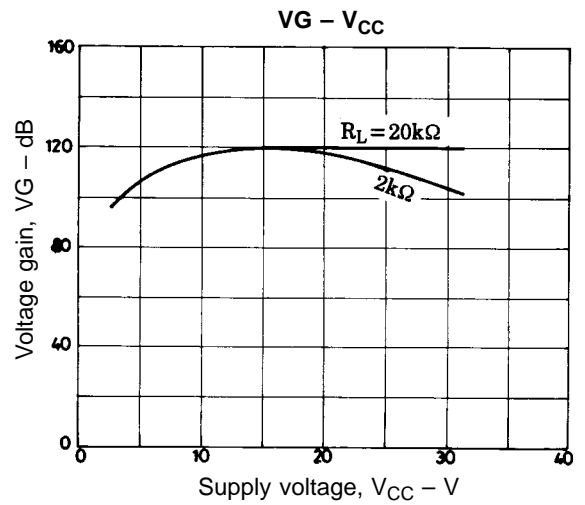
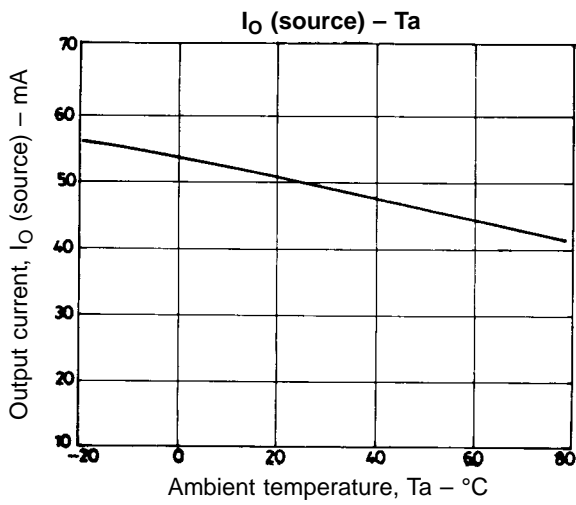
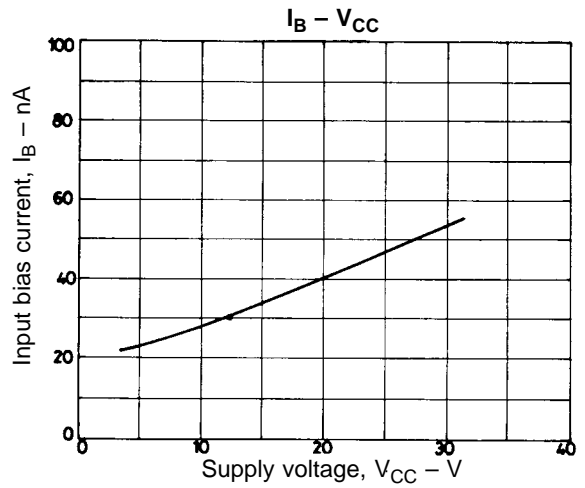
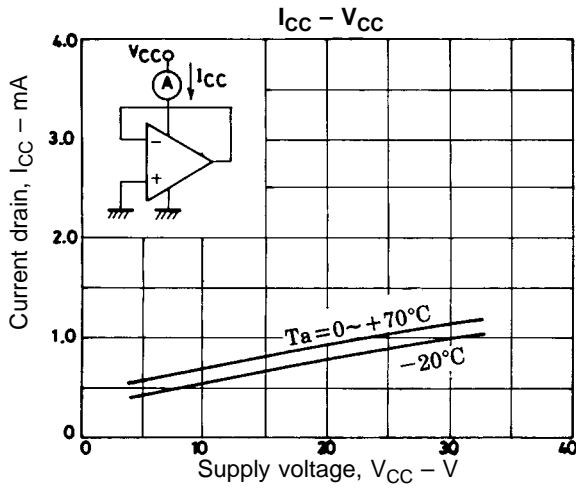
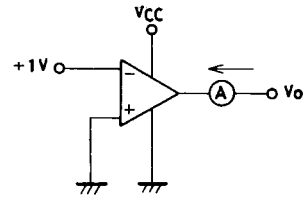

LA6324N, 6324NM

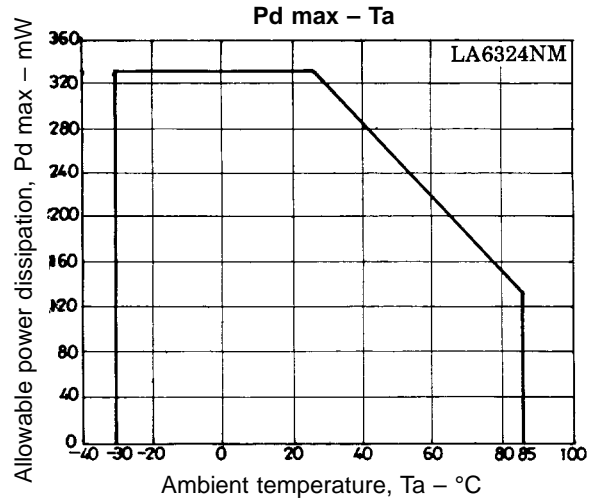
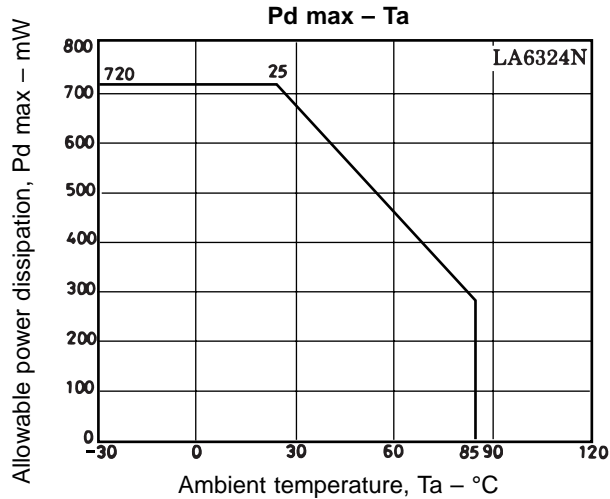

Sample Application Circuits

Noninverting DC amplifier

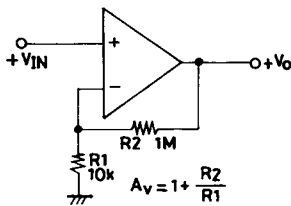

Rectangular wave oscillator

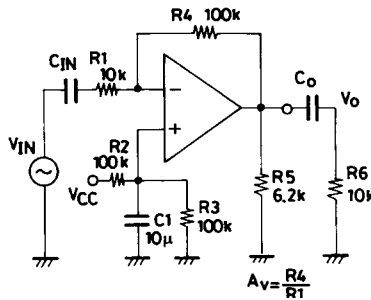

Inverting AC amplifier

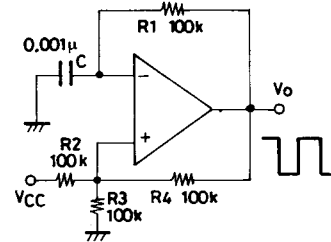

Unit (resistance: Ω , capacitance: F)

- No products described or contained herein are intended for use in surgical implants, life-support systems, aerospace equipment, nuclear power control systems, vehicles, disaster/crime-prevention equipment and the like, the failure of which may directly or indirectly cause injury, death or property loss.
- Anyone purchasing any products described or contained herein for an above-mentioned use shall:
 - ① Accept full responsibility and indemnify and defend SANYO ELECTRIC CO., LTD., its affiliates, subsidiaries and distributors and all their officers and employees, jointly and severally, against any and all claims and litigation and all damages, cost and expenses associated with such use:
 - ② Not impose any responsibility for any fault or negligence which may be cited in any such claim or litigation on SANYO ELECTRIC CO., LTD., its affiliates, subsidiaries and distributors or any of their officers and employees jointly or severally.
- Information (including circuit diagrams and circuit parameters) herein is for example only; it is not guaranteed for volume production. SANYO believes information herein is accurate and reliable, but no guarantees are made or implied regarding its use or any infringements of intellectual property rights or other rights of third parties.

This catalog provides information as of June, 1996. Specifications and information herein are subject to change without notice.