

NPN Silicon High-Voltage Transistors

BFN 24
BFN 26

- Suitable for video output stages in TV sets and switching power supplies
- High breakdown voltage
- Low collector-emitter saturation voltage
- Complementary types: BFN 25, BFN 27 (PNP)

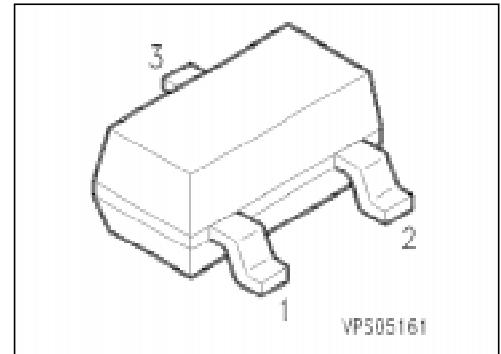

Type	Marking	Ordering Code (tape and reel)	Pin Configuration			Package ¹⁾
			1	2	3	
BFN 24 BFN 26	FHs FJs	Q62702-F1065 Q62702-F976	B	E	C	SOT-23

Maximum Ratings

Parameter	Symbol	Values		Unit
		BFN 24	BFN 26	
Collector-emitter voltage	V_{CE0}	250	300	V
Collector-base voltage	V_{CB0}	250	300	
Emitter-base voltage	V_{EB0}	5		
Collector current	I_C	200		mA
Peak collector current	I_{CM}	500		
Base current	I_B	100		
Peak base current	I_{BM}	200		
Total power dissipation, $T_s = 74\text{ °C}$	P_{tot}	360		mW
Junction temperature	T_j	150		°C
Storage temperature range	T_{stg}	- 65 ... + 150		

Thermal Resistance

Junction - ambient ²⁾	$R_{th\ JA}$	≤ 280	K/W
Junction - soldering point	$R_{th\ JS}$	≤ 210	

¹⁾ For detailed information see chapter Package Outlines.

²⁾ Package mounted on epoxy pcb 40 mm × 40 mm × 1.5 mm/6 cm² Cu.

Electrical Characteristics

at $T_A = 25\text{ °C}$, unless otherwise specified.

Parameter	Symbol	Values			Unit
		min.	typ.	max.	

DC characteristics

Collector-emitter breakdown voltage $I_C = 1\text{ mA}$	$V_{(BR)CE0}$	250 300	– –	– –	V
Collector-base breakdown voltage $I_C = 100\text{ }\mu\text{A}$	$V_{(BR)CB0}$	250 300	– –	– –	
Emitter-base breakdown voltage $I_E = 100\text{ }\mu\text{A}$	$V_{(BR)EB0}$	5	–	–	
Collector-base cutoff current $V_{CB} = 200\text{ V}$ $V_{CB} = 250\text{ V}$ $V_{CB} = 200\text{ V}, T_A = 150\text{ °C}$ $V_{CB} = 250\text{ V}, T_A = 150\text{ °C}$	I_{CB0}	– – – –	– – – –	100 100 20 20	nA nA μA μA
Emitter-base cutoff current $V_{EB} = 3\text{ V}$	I_{EB0}	–	–	100	nA
DC current gain $I_C = 1\text{ mA}, V_{CE} = 10\text{ V}$ $I_C = 10\text{ mA}, V_{CE} = 10\text{ V}^{1)}$ $I_C = 30\text{ mA}, V_{CE} = 10\text{ V}^{1)}$	h_{FE}	25 40 40 30	– – – –	– – – –	–
Collector-emitter saturation voltage ¹⁾ $I_C = 20\text{ mA}, I_B = 2\text{ mA}$	V_{CEsat}	– –	– –	0.4 0.5	V
Base-emitter saturation voltage ¹⁾ $I_C = 20\text{ mA}, I_B = 2\text{ mA}$	V_{BEsat}	–	–	0.9	

AC characteristics

Transition frequency $I_C = 20\text{ mA}, V_{CE} = 10\text{ V}, f = 20\text{ MHz}$	f_T	–	70	–	MHz
Output capacitance $V_{CB} = 30\text{ V}, f = 1\text{ MHz}$	C_{obo}	–	1.5	–	pF

¹⁾ Pulse test conditions: $t \leq 300\text{ }\mu\text{s}$, $D = 2\%$.

Total power dissipation $P_{tot} = f(T_A^*; T_S)$

* Package mounted on epoxy

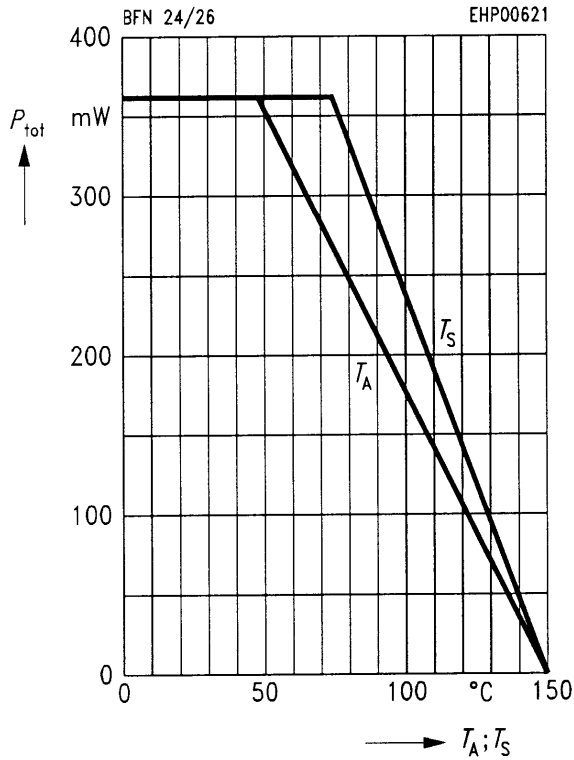

Transition frequency $f_T = f(I_C)$

$V_{CE} = 10\text{ V}$

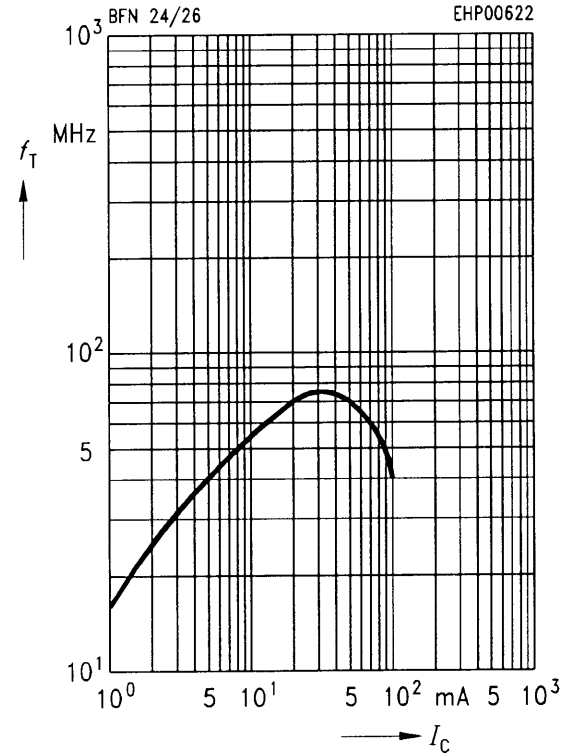

Permissible pulse load $P_{tot\ max} / P_{tot\ DC} = f(t_p)$

Operating range $I_C = f(V_{CE0})$

$T_A = 25\text{ }^\circ\text{C}, D = 0$

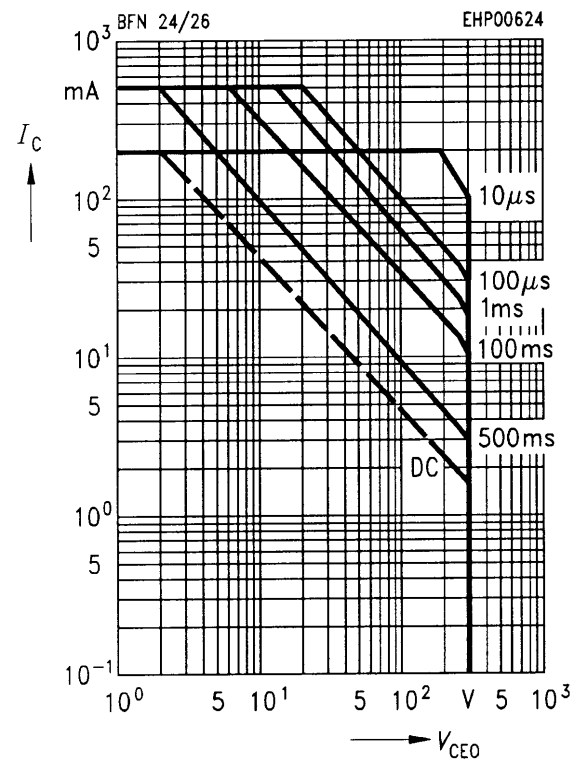
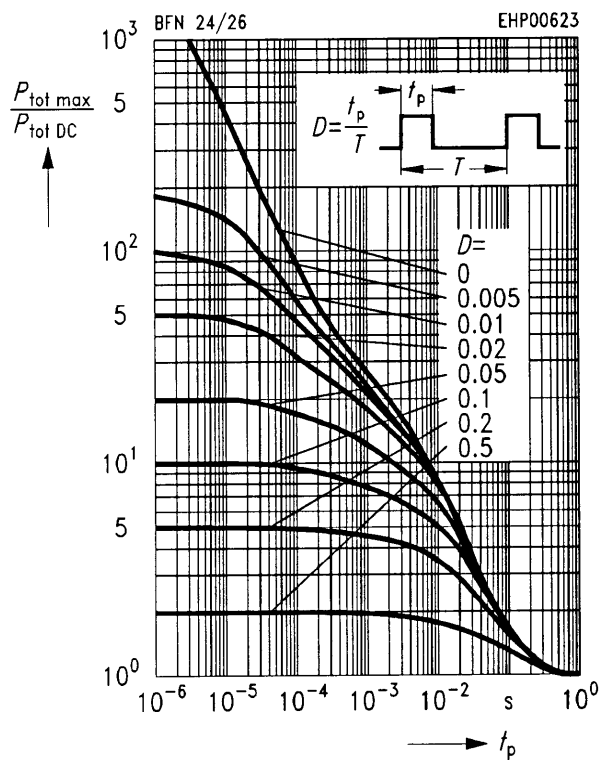

Collector current $I_C = f(V_{BE})$
 $V_{CE} = 10\text{ V}$

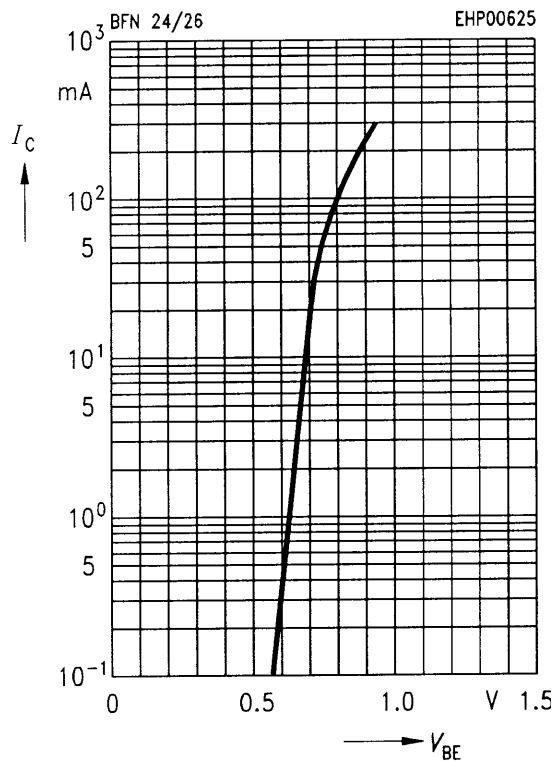

Collector cutoff current $I_{CB0} = f(T_A)$
 $V_{CB} = 200\text{ V}$

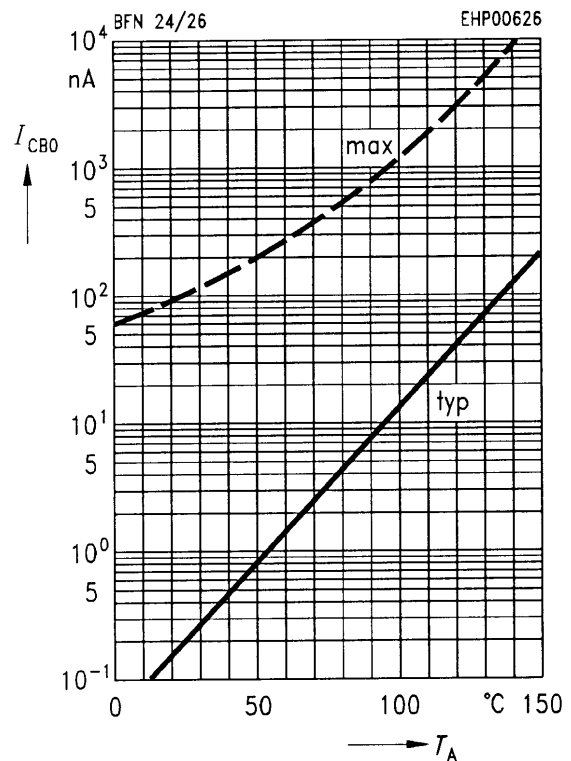

DC current gain $h_{FE} = f(I_C)$
 $V_{CE} = 10\text{ V}$

