

5 mm (T1 3/4) LED, Diffused

LR 5460, LS 5460, LY 5460
LG 5460

Besondere Merkmale

- eingefärbtes, diffuses Gehäuse
- als optischer Indikator einsetzbar
- Lötspieße ohne Aufsetzebene
- gegurtet lieferbar
- Störimpulsfest nach DIN 40839

Features

- colored, diffused package
- for use as optical indicator
- solder leads without stand-off
- available taped on reel
- load dump resistance acc. to DIN 40839

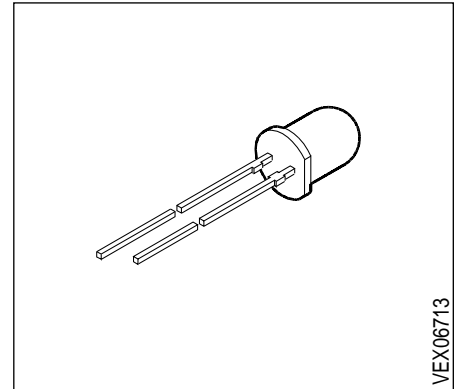

Typ Type	Emissionsfarbe Color of Emission	Gehäusefarbe Color of Package	Lichtstärke Luminous Intensity $I_F = 10 \text{ mA}$ $I_V \text{ (mcd)}$	Bestellnummer Ordering Code
LR 5460-DG LR 5460-F LR 5460-G LR 5460-FJ	red	red diffused	0.4 ... 3.2 1.0 ... 2.0 1.6 ... 3.2 1.0 ... 8.0	Q62703-Q1392 Q62703-Q1393 Q62703-Q1394 Q62703-Q1395
LS 5460-HL LS 5460-J LS 5460-K LS 5460-L LS 5460-JM	super-red	red diffused	2.5 ... 20.0 4.0 ... 8.0 6.3 ... 12.5 10.0 ... 20.0 4.0 ... 32.0	Q62703-Q1396 Q62703-Q1746 Q62703-Q1397 Q62703-Q1398 Q62703-Q3225
LY 5460-HL LY 5460-J LY 5460-K LY 5460-L LY 5460-JM	yellow	yellow diffused	2.5 ... 20.0 4.0 ... 8.0 6.3 ... 12.5 10.0 ... 20.0 4.0 ... 32.0	Q62703-Q1400 Q62703-Q1401 Q62703-Q1402 Q62703-Q2403 Q62703-Q1403
LG 5460-GK LG 5460-H LG 5460-J LG 5460-K LG 5460-HL	green	green diffused	1.6 ... 12.5 2.5 ... 5.0 4.0 ... 8.0 6.3 ... 12.5 2.5 ... 20.0	Q62703-Q1407 Q62703-Q1406 Q62703-Q1867 Q62703-Q2014 Q62703-Q3190

Streuung der Lichtstärke in einer Verpackungseinheit $I_{V \max} / I_{V \min} \leq 2.0$.

Luminous intensity ratio in one packaging unit $I_{V \max} / I_{V \min} \leq 2.0$.

Grenzwerte
Maximum Ratings

Bezeichnung Parameter	Symbol Symbol	Werte Values		Einheit Unit
		LR	LS, LY, LG	
Betriebstemperatur Operating temperature range	T_{op}	- 55 ... + 100		°C
Lagertemperatur Storage temperature range	T_{stg}	- 55 ... + 100		°C
Sperrschichttemperatur Junction temperature	T_j	+ 100		°C
Durchlaßstrom Forward current	I_F	45	40	mA
Stoßstrom Surge current $t \leq 10 \mu s, D = 0.005$	I_{FM}	0.5		A
Sperrspannung Reverse voltage	V_R	5		V
Verlustleistung Power dissipation $T_A \leq 25 \text{ °C}$	P_{tot}	100	140	mW
Wärmewiderstand Thermal resistance Sperrschicht / Luft Junction / air	$R_{th JA}$	400		K/W

Kennwerte ($T_A = 25\text{ °C}$)

Characteristics

Bezeichnung Parameter	Symbol Symbol	Werte Values				Einheit Unit
		LR	LS	LY	LG	
Wellenlänge des emittierten Lichtes Wavelength at peak emission $I_F = 20\text{ mA}$	(typ.) λ_{peak} (typ.)	660	635	586	565	nm
Dominantwellenlänge Dominant wavelength $I_F = 20\text{ mA}$	(typ.) λ_{dom} (typ.)	645	628	590	570	nm
Spektrale Bandbreite bei 50 % $I_{\text{rel max}}$ Spectral bandwidth at 50 % $I_{\text{rel max}}$ $I_F = 20\text{ mA}$	(typ.) $\Delta\lambda$ (typ.)	35	45	45	25	nm
Abstrahlwinkel bei 50 % I_V (Vollwinkel) Viewing angle at 50 % I_V	2ϕ	50	50	50	50	Grad deg.
Durchlaßspannung Forward voltage $I_F = 10\text{ mA}$	(typ.) V_F (max.) V_F	1.6 2.0	2.0 2.6	2.0 2.6	2.0 2.6	V V
Sperrstrom Reverse current $V_R = 5\text{ V}$	(typ.) I_R (max.) I_R	0.01 10	0.01 10	0.01 10	0.01 10	μA μA
Kapazität Capacitance $V_R = 0\text{ V}, f = 1\text{ MHz}$	(typ.) C_0	25	12	10	15	pF
Schaltzeiten: Switching times: I_V from 10 % to 90 % I_V from 90 % to 10 % $I_F = 100\text{ mA}, t_p = 10\text{ }\mu\text{s}, R_L = 50\text{ }\Omega$	(typ.) t_r (typ.) t_f	120 50	300 150	300 150	450 200	ns ns

Relative spektrale Emission $I_{rel} = f(\lambda)$, $T_A = 25\text{ °C}$, $I_F = 20\text{ mA}$

Relative spectral emission

$V(\lambda)$ = spektrale Augenempfindlichkeit

Standard eye response curve

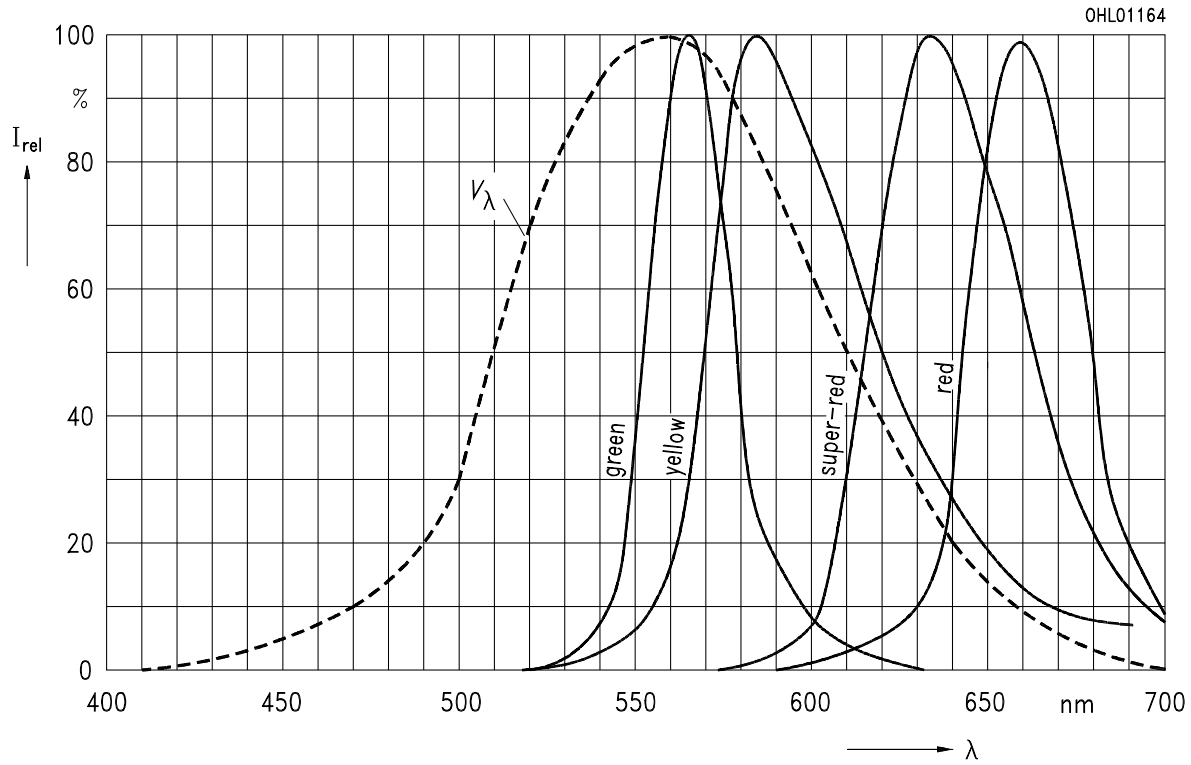

Abstrahlcharakteristik $I_{rel} = f(\varphi)$

Radiation characteristic

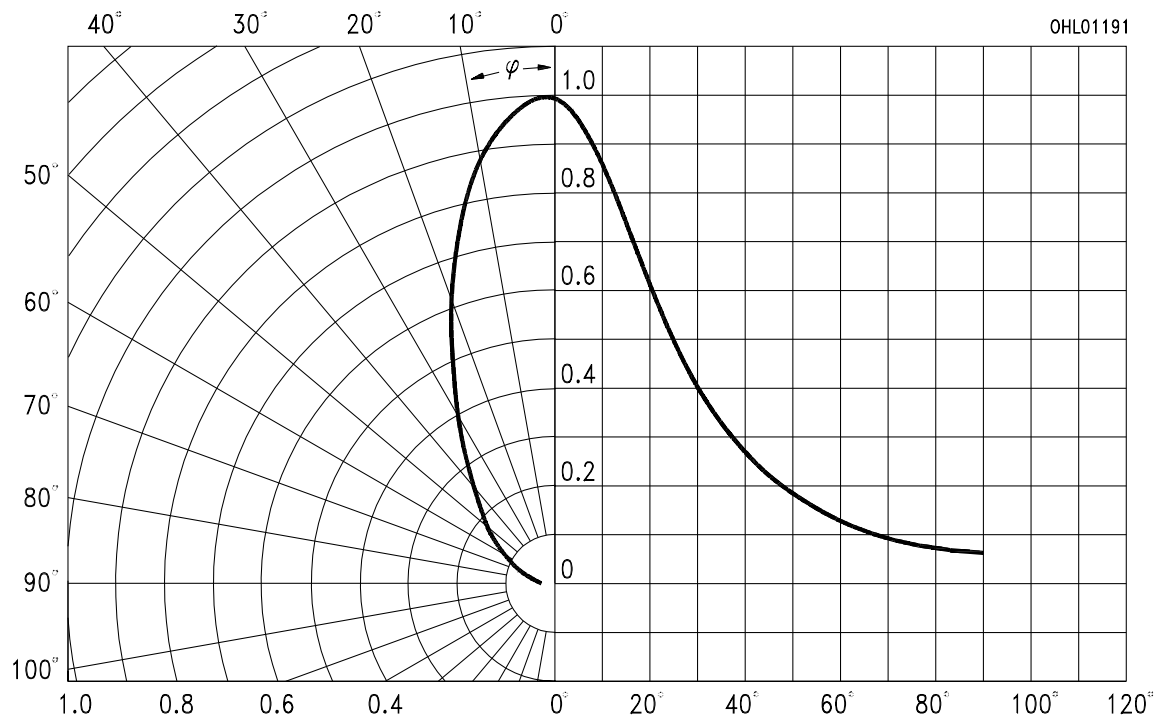

Durchlaßstrom $I_F = f(V_F)$

Forward current

$T_A = 25\text{ °C}$

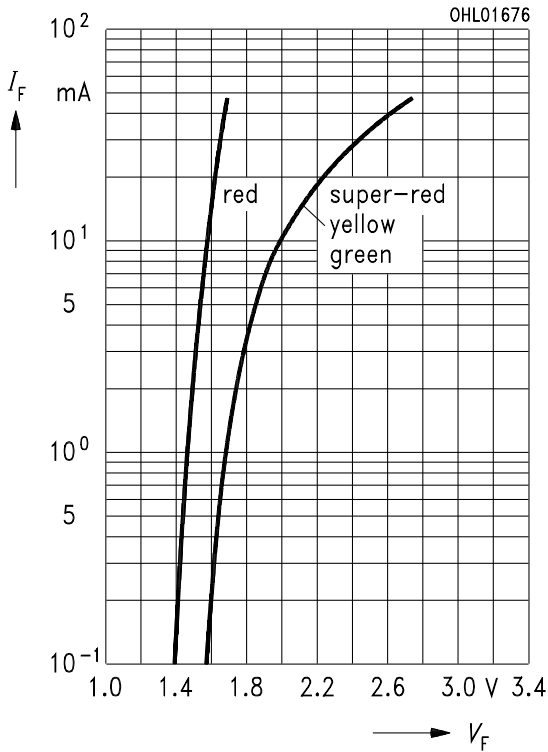

Relative Lichtstärke $I_V/I_{V(10\text{ mA})} = f(I_F)$

Relative luminous intensity

$T_A = 25\text{ °C}$

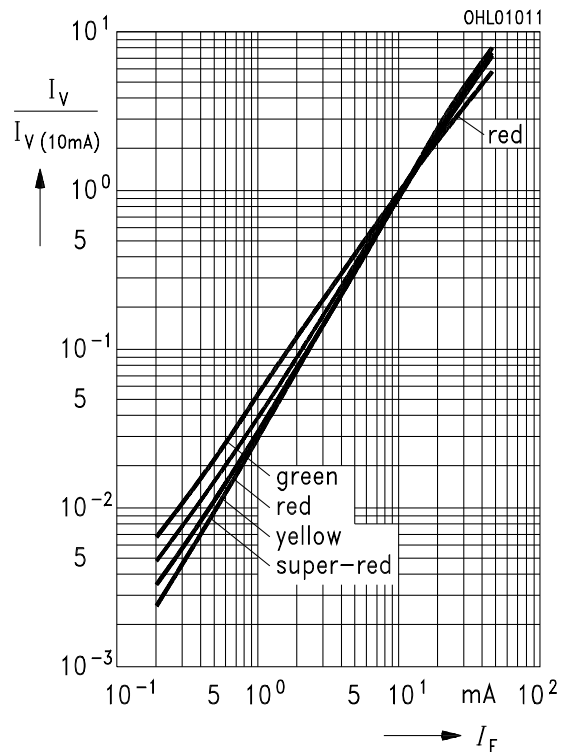

Zulässige Impulsbelastbarkeit $I_F = f(t_p)$

Permissible pulse handling capability

Duty cycle $D =$ parameter, $T_A = 25\text{ °C}$

LS, LY, LG

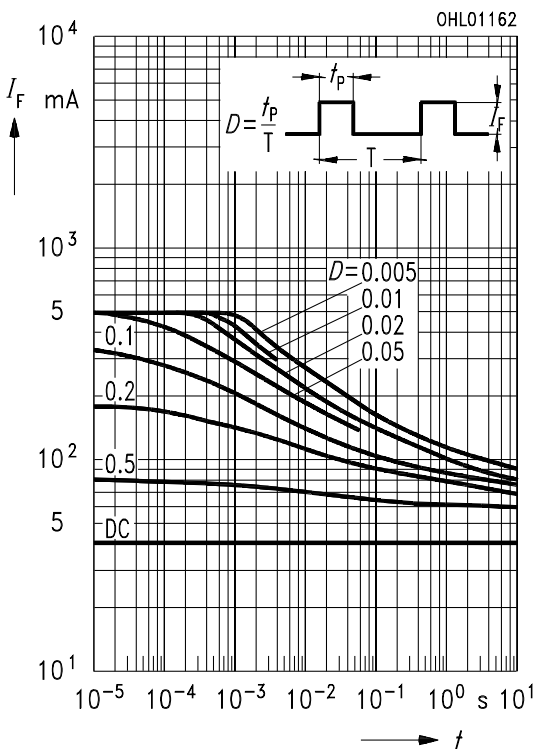

Zulässige Impulsbelastbarkeit $I_F = f(t_p)$

Permissible pulse handling capability

Duty cycle $D =$ parameter, $T_A = 25\text{ °C}$

LR

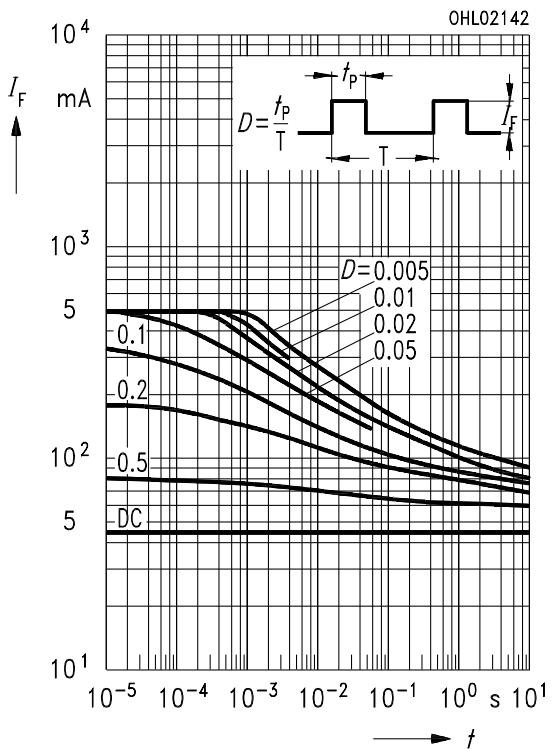

Maximal zulässiger Durchlaßstrom Max. permissible forward current

$$I_F = f(T_A)$$

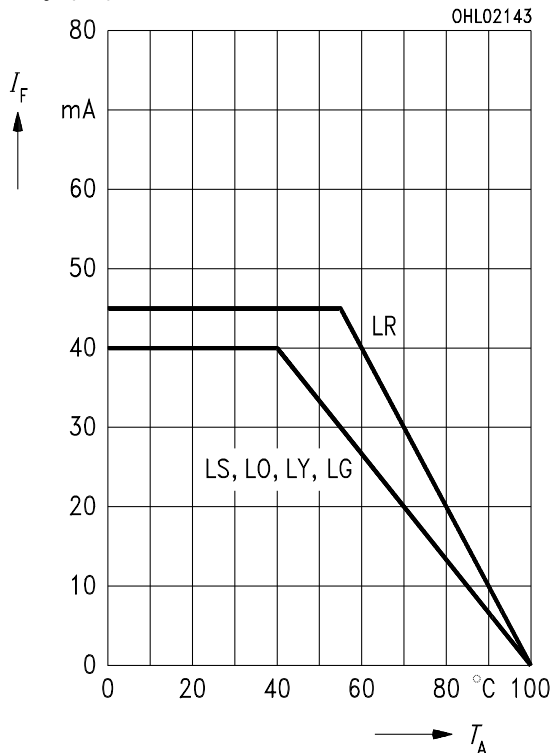

Wellenlänge der Strahlung $\lambda_{\text{peak}} = f(T_A)$ Wavelength at peak emission

$$I_F = 20 \text{ mA}$$

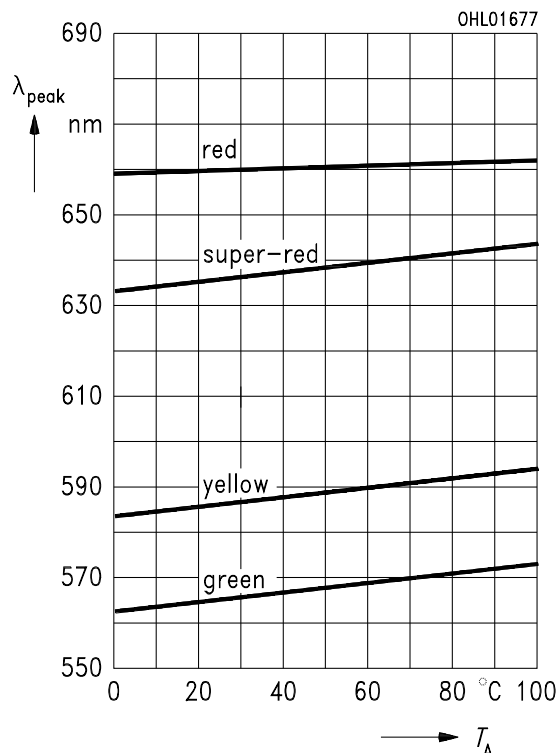

Dominantwavelength $\lambda_{\text{dom}} = f(T_A)$ Dominant wavelength

$$I_F = 20 \text{ mA}$$

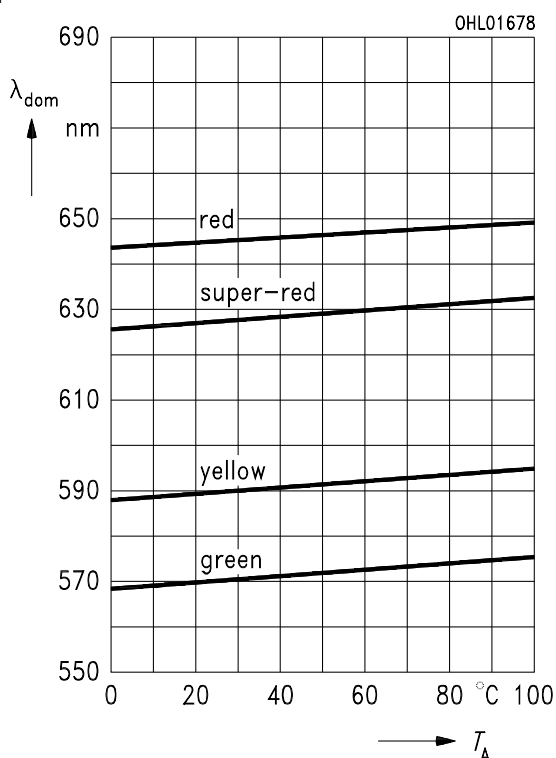

Durchlaßspannung $V_F = f(T_A)$ Forward voltage

$$I_F = 10 \text{ mA}$$

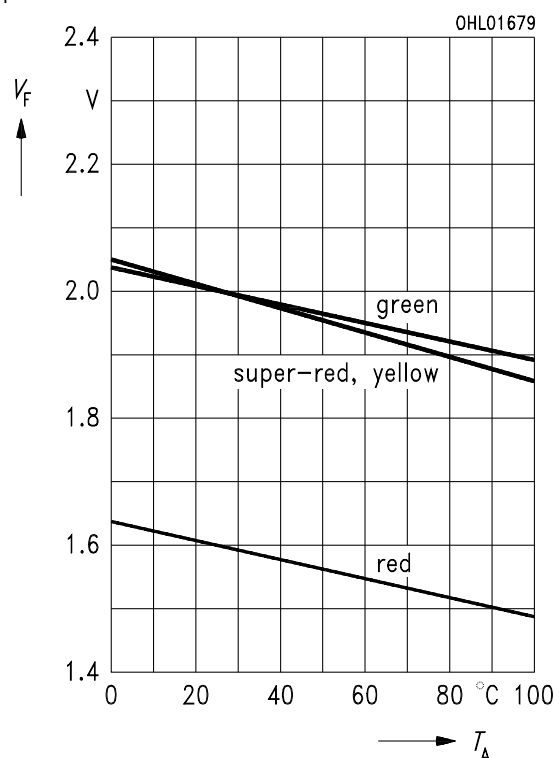

Relative Lichtstärke $I_V/I_{V(25^\circ\text{C})} = f(T_A)$

Relative luminous intensity

$I_F = 10 \text{ mA}$

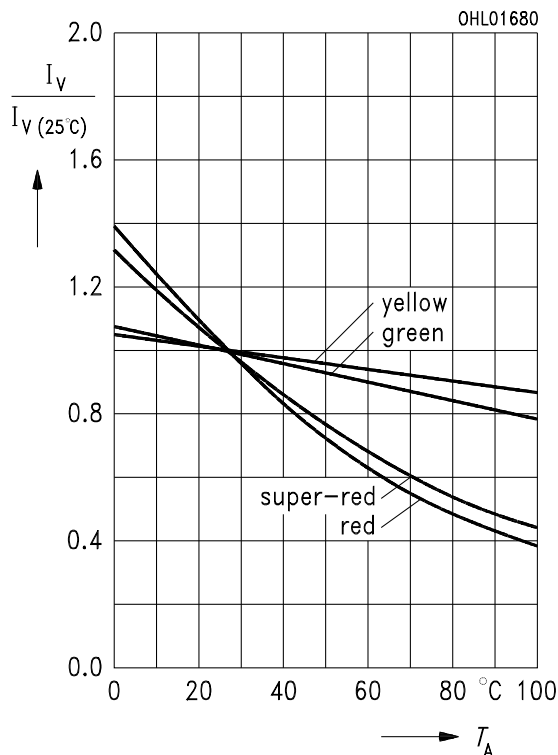

Maßzeichnung (Maße in mm, wenn nicht anders angegeben)
Package Outlines (Dimensions in mm, unless otherwise specified)

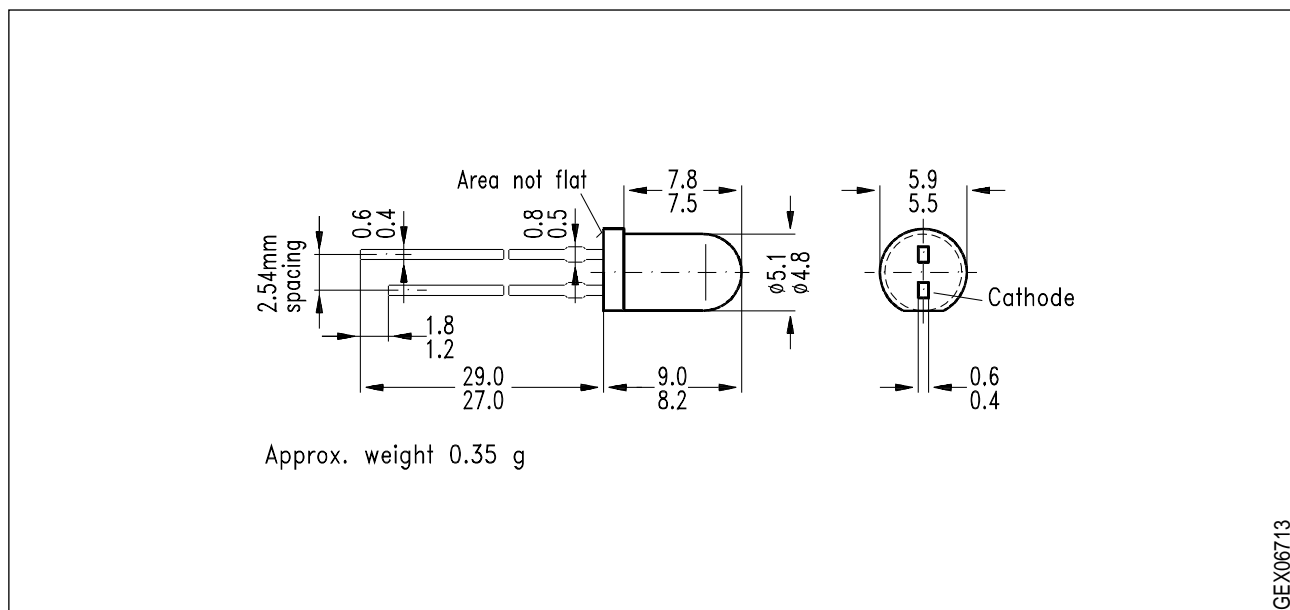

Kathodenkennzeichnung: Kürzerer Lötspieß
Cathode mark: Short solder lead