



BUH1015 BUH1015HI

HIGH VOLTAGE FAST-SWITCHING NPN POWER TRANSISTOR

- STMicroelectronics PREFERRED SALESTYPES
- HIGH VOLTAGE CAPABILITY
- VERY HIGH SWITCHING SPEED

APPLICATIONS:

- HORIZONTAL DEFLECTION FOR COLOUR TV AND MONITORS

DESCRIPTION

The BUH1015 and BUH1015HI are manufactured using Multi-epitaxial Mesa technology for cost-effective high performance and use a Hollow Emitter structure to enhance switching speeds.

The BUH series is designed for use in horizontal deflection circuits in televisions and monitors.

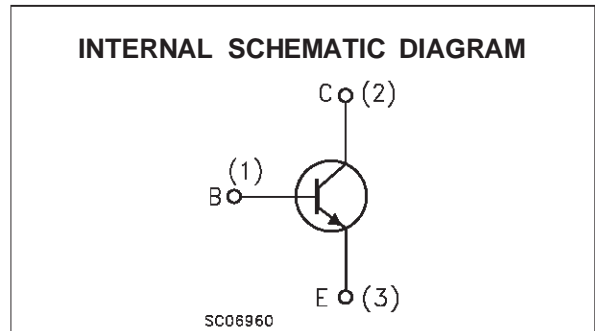
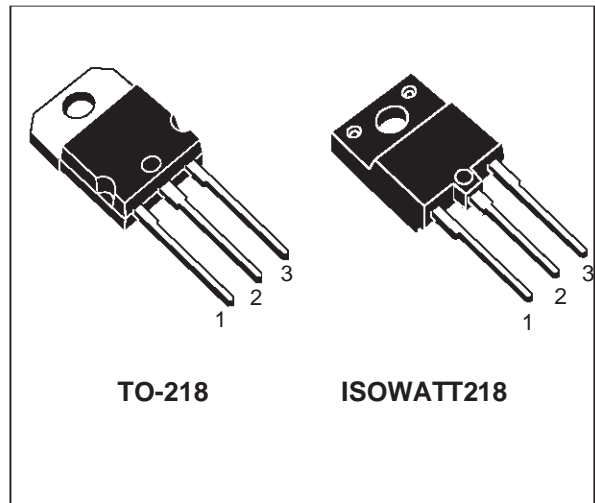

ABSOLUTE MAXIMUM RATINGS

Symbol	Parameter	Value	Unit	
V_{CBO}	Collector-Base Voltage ($I_E = 0$)	1500	V	
V_{CEO}	Collector-Emitter Voltage ($I_B = 0$)	700	V	
V_{EBO}	Emitter-Base Voltage ($I_C = 0$)	10	V	
I_C	Collector Current	14	A	
I_{CM}	Collector Peak Current ($t_p < 5$ ms)	18	A	
I_B	Base Current	8	A	
I_{BM}	Base Peak Current ($t_p < 5$ ms)	11	A	
P_{tot}	Total Dissipation at $T_c = 25$ °C	160	70	W
T_{stg}	Storage Temperature	-65 to 150	°C	
T_j	Max. Operating Junction Temperature	150	°C	

BUH1015/BUH1015HI

THERMAL DATA

			TO-218	ISOWATT218	
$R_{thj-case}$	Thermal Resistance Junction-case	Max	0.78	1.8	$^{\circ}\text{C}/\text{W}$

ELECTRICAL CHARACTERISTICS ($T_{case} = 25^{\circ}\text{C}$ unless otherwise specified)

Symbol	Parameter	Test Conditions	Min.	Typ.	Max.	Unit
I_{CES}	Collector Cut-off Current ($V_{BE} = 0$)	$V_{CE} = 1500\text{ V}$ $V_{CE} = 1500\text{ V}$ $T_j = 125^{\circ}\text{C}$			0.2 2	 mA mA
I_{EBO}	Emitter Cut-off Current ($I_C = 0$)	$V_{EB} = 5\text{ V}$			100	μA
$V_{CEO(sus)}^*$	Collector-Emitter Sustaining Voltage ($I_B = 0$)	$I_C = 100\text{ mA}$	700			V
V_{EBO}	Emitter-Base Voltage ($I_C = 0$)	$I_E = 10\text{ mA}$	10			V
$V_{CE(sat)}^*$	Collector-Emitter Saturation Voltage	$I_C = 10\text{ A}$ $I_B = 2\text{ A}$			1.5	V
$V_{BE(sat)}^*$	Base-Emitter Saturation Voltage	$I_C = 10\text{ A}$ $I_B = 2\text{ A}$			1.5	V
h_{FE}^*	DC Current Gain	$I_C = 10\text{ A}$ $V_{CE} = 5\text{ V}$ $I_C = 10\text{ A}$ $V_{CE} = 5\text{ V}$ $T_j = 100^{\circ}\text{C}$	7 5	10	14	
t_s t_f	RESISTIVE LOAD Storage Time Fall Time	$V_{CC} = 400\text{ V}$ $I_C = 10\text{ A}$ $I_{B1} = 2\text{ A}$ $I_{B2} = -6\text{ A}$		1.5 110		μs ns
t_s t_f	INDUCTIVE LOAD Storage Time Fall Time	$I_C = 10\text{ A}$ $f = 31250\text{ Hz}$ $I_{B1} = 2\text{ A}$ $I_{B2} = -6\text{ A}$ $V_{ceflyback} = 1200 \sin\left(\frac{\pi}{5} 10^6\right) t \text{ V}$		4 220		μs ns
t_s t_f	INDUCTIVE LOAD Storage Time Fall Time	$I_C = 6\text{ A}$ $f = 64\text{ KHz}$ $I_{B1} = 1\text{ A}$ $V_{beoff} = -2\text{ V}$ $V_{ceflyback} = 1100 \sin\left(\frac{\pi}{5} 10^6\right) t \text{ V}$		3.7 200		μs ns

* Pulsed: Pulse duration = 300 μs , duty cycle 1.5 %

Safe Operating Area For TO-218

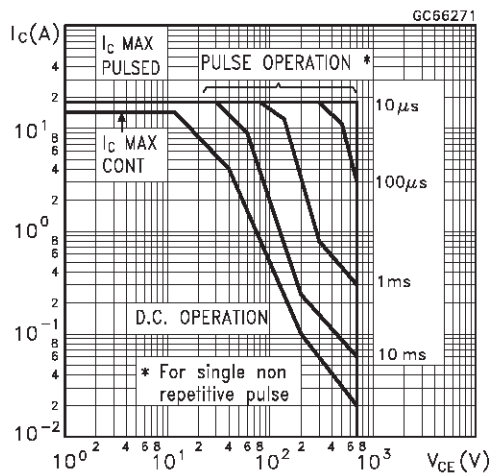

Safe Operating Area For ISOWATT218

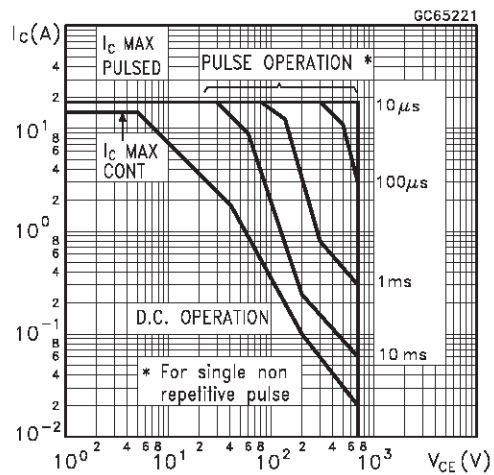

Thermal Impedance for TO-218

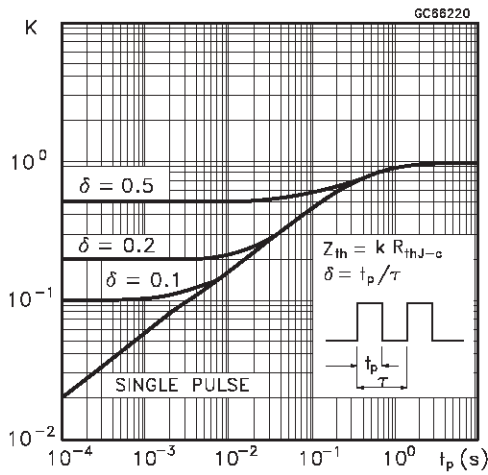

Thermal Impedance for ISOWATT218

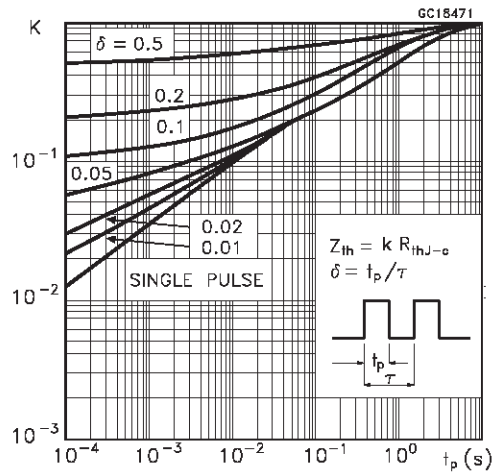

Derating Curve

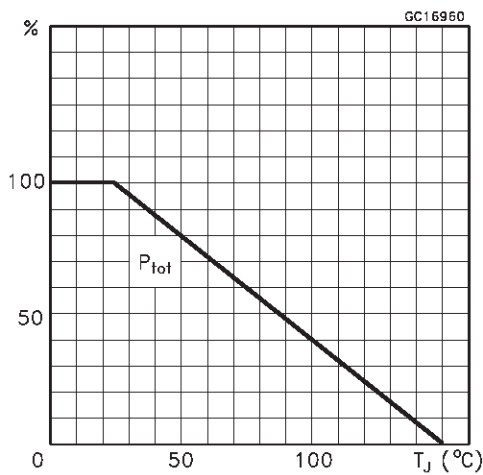

DC Current Gain

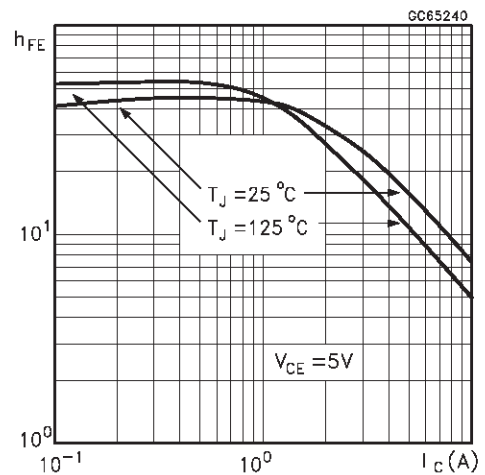

Collector Emitter Saturation Voltage

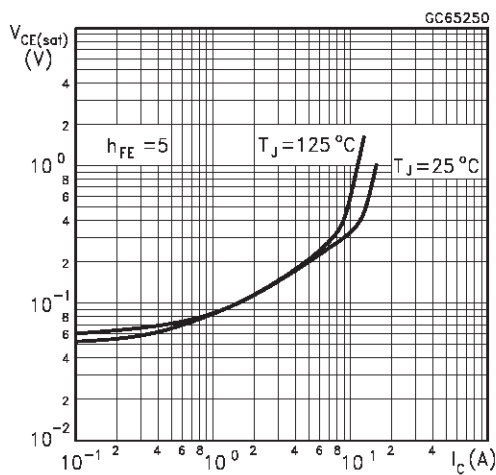

Base Emitter Saturation Voltage

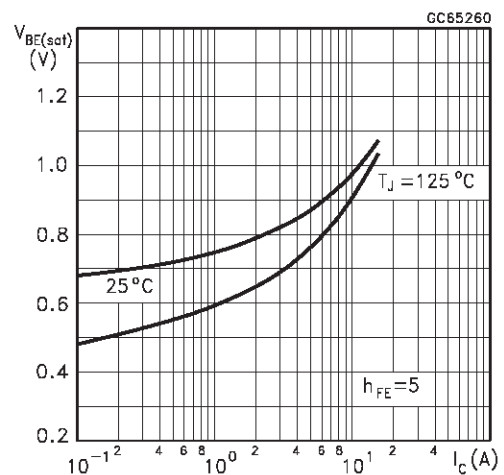

Power Losses at 64 KHz

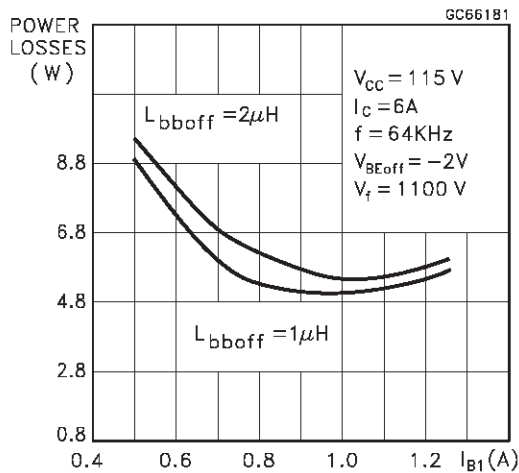

Switching Time Inductive Load at 64KHz (see figure 2)

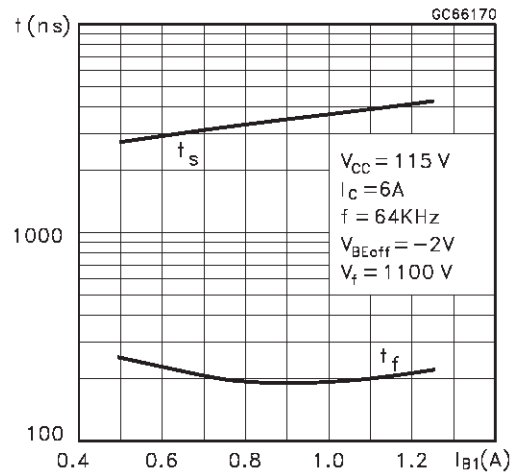

Reverse Biased SOA

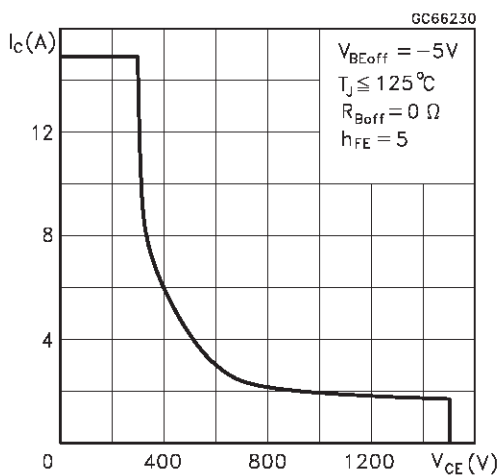

BASE DRIVE INFORMATION

In order to saturate the power switch and reduce conduction losses, adequate direct base current I_{B1} has to be provided for the lowest gain h_{FE} at $T_j = 100\text{ }^\circ\text{C}$ (line scan phase). On the other hand, negative base current I_{B2} must be provided the transistor to turn off (retrace phase). Most of the dissipation, especially in the deflection application, occurs at switch-off so it is essential to determine the value of I_{B2} which minimizes power losses, fall time t_f and, consequently, T_j . A new set of curves have been defined to give total power losses, t_s and t_f as a function of I_{B1} at 64 KHz scanning frequencies for choosing the

optimum drive. The test circuit is illustrated in figure 1.

The values of L and C are calculated from the following equations:

$$\frac{1}{2} L (I_C)^2 = \frac{1}{2} C (V_{CE\text{fly}})^2$$

$$\omega = 2\pi f = \frac{1}{\sqrt{LC}}$$

Where I_C = operating collector current, $V_{CE\text{fly}}$ = flyback voltage, f = frequency of oscillation during retrace.

Figure 1: Inductive Load Switching Test Circuits.

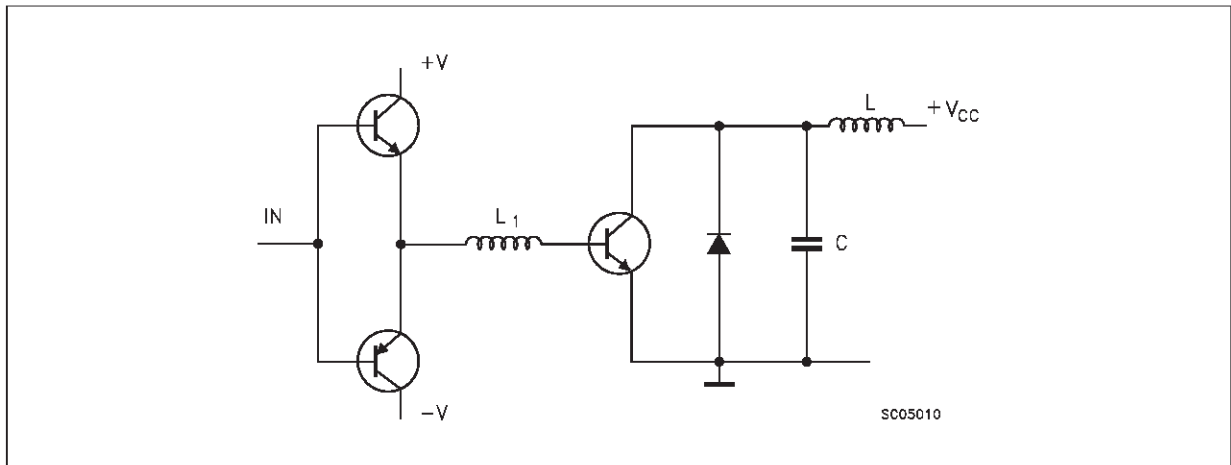
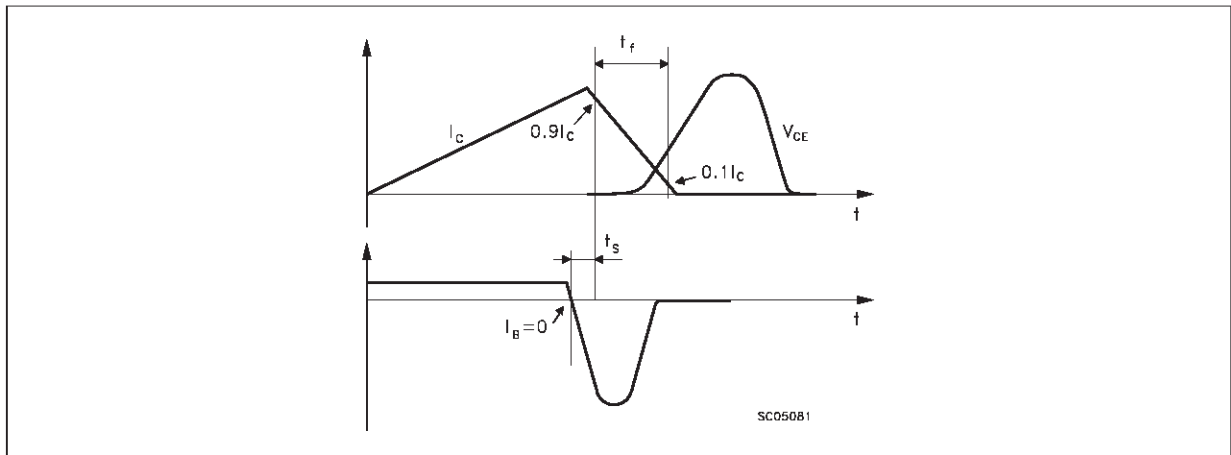
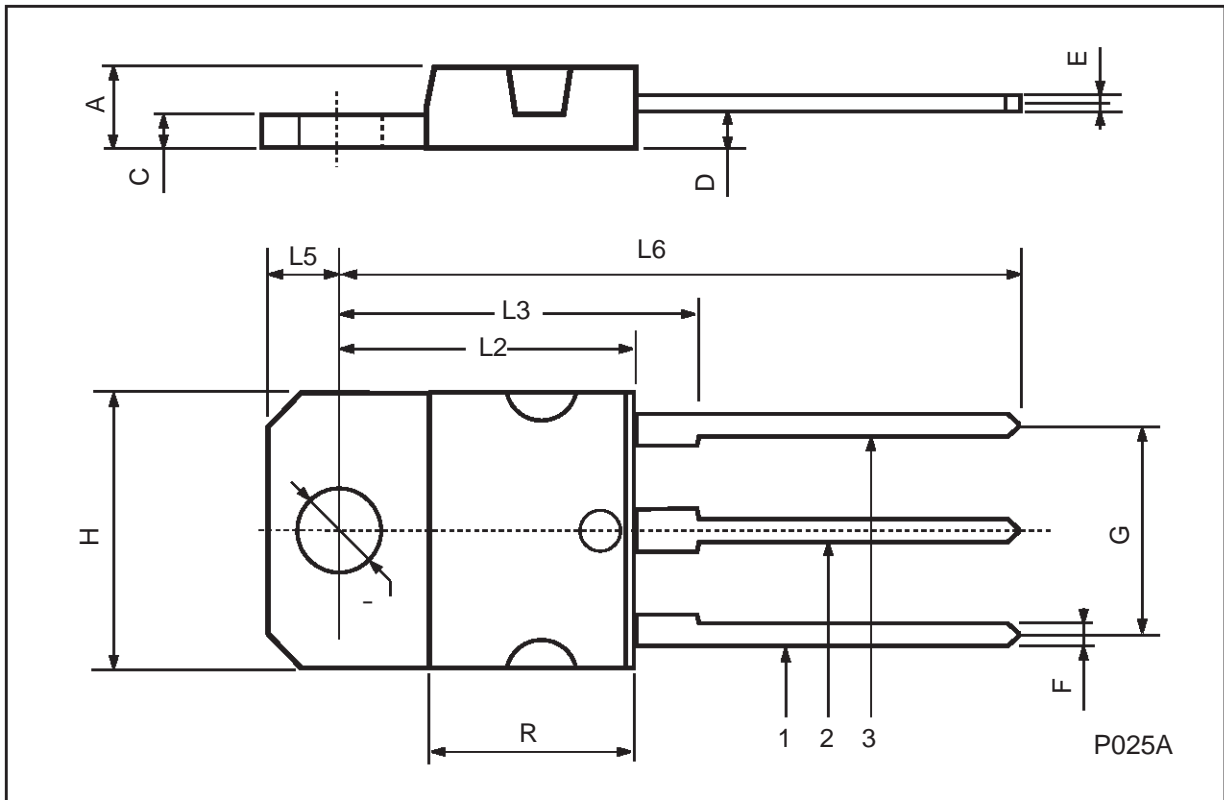

Figure 2: Switching Waveforms in a Deflection Circuit



TO-218 (SOT-93) MECHANICAL DATA

DIM.	mm			inch		
	MIN.	TYP.	MAX.	MIN.	TYP.	MAX.
A	4.7		4.9	0.185		0.193
C	1.17		1.37	0.046		0.054
D		2.5			0.098	
E	0.5		0.78	0.019		0.030
F	1.1		1.3	0.043		0.051
G	10.8		11.1	0.425		0.437
H	14.7		15.2	0.578		0.598
L2	-		16.2	-		0.637
L3		18			0.708	
L5	3.95		4.15	0.155		0.163
L6		31			1.220	
R	-		12.2	-		0.480
Ø	4		4.1	0.157		0.161



ISOWATT218 MECHANICAL DATA

DIM.	mm			inch		
	MIN.	TYP.	MAX.	MIN.	TYP.	MAX.
A	5.35		5.65	0.211		0.222
C	3.30		3.80	0.130		0.150
D	2.90		3.10	0.114		0.122
D1	1.88		2.08	0.074		0.082
E	0.75		0.95	0.030		0.037
F	1.05		1.25	0.041		0.049
F2	1.50		1.70	0.059		0.067
F3	1.90		2.10	0.075		0.083
G	10.80		11.20	0.425		0.441
H	15.80		16.20	0.622		0.638
L		9			0.354	
L1	20.80		21.20	0.819		0.835
L2	19.10		19.90	0.752		0.783
L3	22.80		23.60	0.898		0.929
L4	40.50		42.50	1.594		1.673
L5	4.85		5.25	0.191		0.207
L6	20.25		20.75	0.797		0.817
N	2.1		2.3	0.083		0.091
R		4.6			0.181	
DIA	3.5		3.7	0.138		0.146

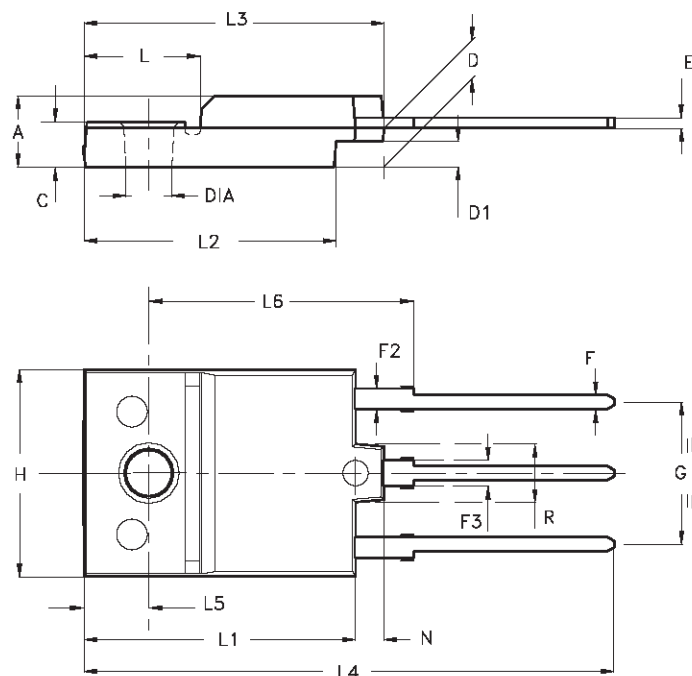

- Weight : 4.9 g (typ.)

- Maximum Torque (applied to mounting flange) Recommended: 0.8 Nm; Maximum: 1 Nm

- The side of the dissipator must be flat within 80 μ m

P025C/A

Information furnished is believed to be accurate and reliable. However, STMicroelectronics assumes no responsibility for the consequences of use of such information nor for any infringement of patents or other rights of third parties which may result from its use. No license is granted by implication or otherwise under any patent or patent rights of STMicroelectronics. Specification mentioned in this publication are subject to change without notice. This publication supersedes and replaces all information previously supplied. STMicroelectronics products are not authorized for use as critical components in life support devices or systems without express written approval of STMicroelectronics.

The ST logo is a trademark of STMicroelectronics

© 1999 STMicroelectronics – Printed in Italy – All Rights Reserved

STMicroelectronics GROUP OF COMPANIES

Australia - Brazil - China - Finland - France - Germany - Hong Kong - India - Italy - Japan - Malaysia - Malta - Morocco - Singapore - Spain - Sweden - Switzerland - United Kingdom - U.S.A.

<http://www.st.com>