

Dual 1 Form A Solid State Relay (Low Capacitance)

Features

- Dual Channel, LH1541 Type
- Low Capacitance Switch (5.0 pF)
- Isolation Test Voltage 5300 V_{RMS}
- Extremely High OFF-resistance
- Load Voltage 200 V
- Clean Bounce Free Switching
- Low Power Consumption
- High Reliability Monolithic detector
- Lead-free component
- Component in accordance to RoHS 2002/95/EC and WEEE 2002/96/EC

Agency Approvals

- UL1577, File No. E52744 System Code H or J, Double Protection
- CSA - Certification 093751
- BSI/BABT Cert. No. 7980
- DIN EN 60747-5-2 (VDE0884)
DIN EN 60747-5-5 pending
- FIMKO Approval

Applications

Instrumentation
 - Thermocouple Switching
 - Analog Multiplexing
 Reed Relay Replacement
 Programmable Logic Controllers
 Data Acquisition
 Test Equipment

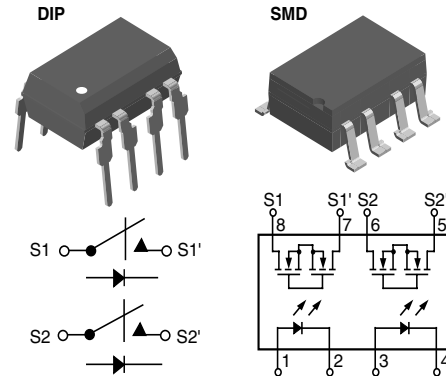

1179034



Description

These dual SSRs (LH1544, Dual 1 Form A) are SPST normally open switches which can replace electromechanical relays in many applications. The relays provide a low-capacitance, high-voltage switch contact with high off-resistance and low switch-offset voltage. These characteristics, combined with high-speed actuation, result in an SSR which is ideal for small signal and dc instrumentation applications.

The relays are constructed by using a GaAlAs LED for actuation control and an integrated monolithic die for the switch output. The die is comprised of a photo-diode array, switch-control circuitry, and low-capacitance MOSFET switches.

Order Information

Part	Remarks
LH1544AAC	Tubes, SMD-8
LH1544AACTR	Tape and Reel, SMD-8
LH1544AB	Tubes, DIP-8

Absolute Maximum Ratings, $T_{amb} = 25\text{ }^{\circ}\text{C}$

Stresses in excess of the absolute Maximum Ratings can cause permanent damage to the device. Functional operation of the device is not implied at these or any other conditions in excess of those given in the operational sections of this document. Exposure to absolute Maximum Ratings for extended periods of time can adversely affect reliability.

SSR

Parameter	Test condition	Symbol	Value	Unit
LED continuous forward current		I_F	50	mA
LED reverse voltage	$I_R \leq 10\text{ }\mu\text{A}$	V_R	8.0	V
DC or peak AC load voltage	$I_L \leq 50\text{ }\mu\text{A}$	V_L	200	V
Continuous DC load current - one pole operating		I_L	55	mA
Continuous DC load current - two pole operating		I_L	40	mA
Peak load current (single shot)	$t = 100\text{ ms}$	I_P	100	mA
Ambient temperature range		T_{amb}	- 40 to + 85	$^{\circ}\text{C}$
Storage temperature range		T_{stg}	- 40 to + 150	$^{\circ}\text{C}$
Pin soldering temperature	$t = 10\text{ s max}$	T_{sld}	260	$^{\circ}\text{C}$
Input/output isolation voltage		V_{ISO}	5300	V_{RMS}
Pole-to-pole isolation voltage (S1 to S2) ¹⁾	dry air, dust free, at sea level		1600	V
Output power dissipation (continuous)		P_{diss}	600	mW

¹⁾ Breakdown occurs between the output pins external to the package

Electrical Characteristics, $T_{amb} = 25\text{ }^{\circ}\text{C}$

Minimum and maximum values are testing requirements. Typical values are characteristics of the device and are the result of engineering evaluations. Typical values are for information only and are not part of the testing requirements.

Input

Parameter	Test condition	Symbol	Min	Typ.	Max	Unit
LED forward current, switch turn-on	$I_L = 100\text{ mA}$, $t = 10\text{ ms}$	I_{Fon}		0.9	2.0	mA
LED forward current, switch turn-off	$V_L = \pm 300\text{ V}$	I_{Foff}	0.2	0.8		mA
LED forward voltage	$I_F = 5.0\text{ mA}$	V_F	1.10	1.19	1.45	V

Output

Parameter	Test condition	Symbol	Min	Typ.	Max	Unit
ON-resistance	$I_F = 5.0\text{ mA}$, $I_L = 50\text{ mA}$	R_{ON}	70	110	160	Ω
Off-resistance	$I_F = 0\text{ mA}$, $V_L = \pm 100\text{ V}$	R_{OFF}	0.5	10000		$\text{G}\Omega$
Off-state leakage current	$I_F = 0\text{ mA}$, $V_L = \pm 100\text{ V}$	I_O		0.01	200	nA
	$I_F = 0\text{ mA}$, $V_L = \pm 350\text{ V}$	I_O			1.0	μA
Output capacitance	$I_F = 0\text{ mA}$, $V_L = 1.0\text{ V}$	C_O		0		pF
Output capacitance Pin 4 to 6	$I_F = 0\text{ mA}$, $V_L = 50\text{ V}$	C_O		0.5		pF
Pole-to-pole Capacitance (S1 to S2)	$I_F = 5.0\text{ mA}$			0.5		pF
Switch offset	$I_F = 5.0\text{ mA}$	V_{OS}		0.1		V

Transfer

Parameter	Test condition	Symbol	Min	Typ.	Max	Unit
Capacitance (input-output)	$V_{ISO} = 1.0\text{ V}$	C_{IO}		1.1		pF
Turn-on time	$I_F = 5.0\text{ mA}$, $I_L = 50\text{ mA}$	t_{on}		0.13	0.25	ms
Turn-off time	$I_F = 5.0\text{ mA}$, $I_L = 50\text{ mA}$	t_{off}		0.6	0.25	ms

Footnotes

The following information refers to the SSR Recommended Operation Conditions:

- Both relays on with equal load currents. For single relay operation, refer to the LH1541 Recommended Operating Conditions graph.

Typical Characteristics ($T_{amb} = 25\text{ }^\circ\text{C}$ unless otherwise specified)

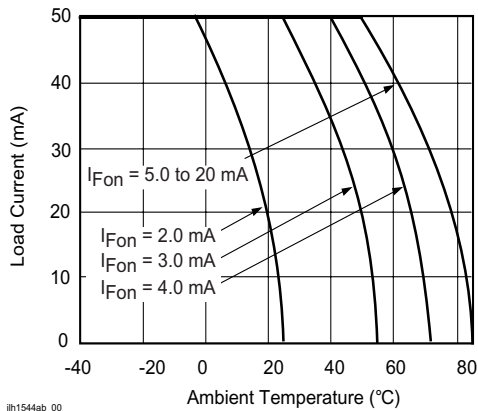

Figure 1. Recommended Operating Conditions

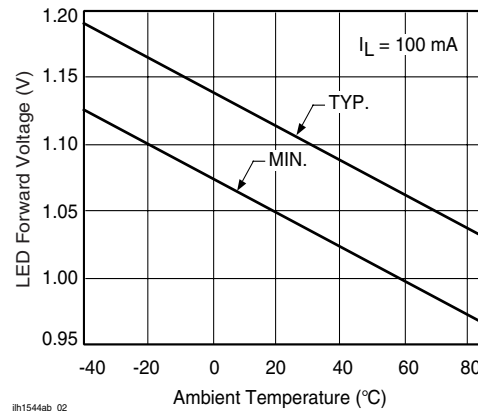

Figure 3. LED Dropout Voltage vs. Temperature

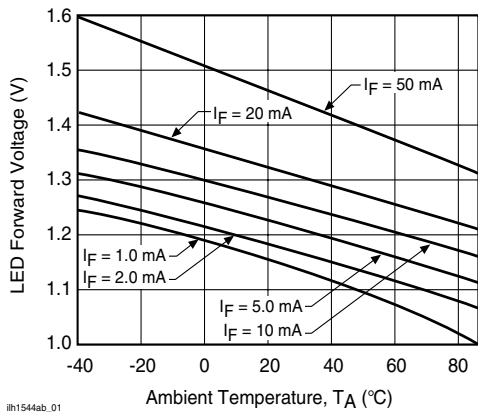

Figure 2. LED Voltage vs. Temperature

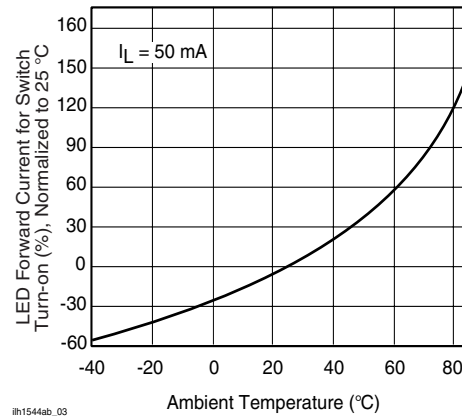

Figure 4. LED Current for Switch Turn-on vs. Temperature

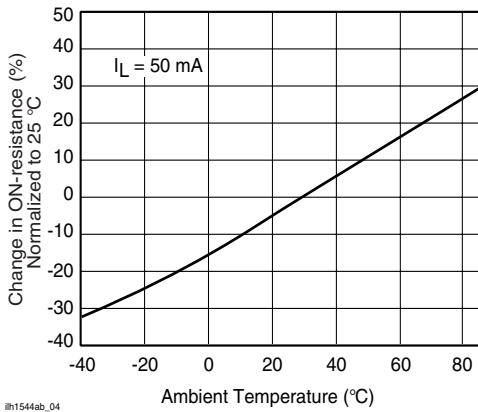

Figure 5. ON-Resistance vs. Temperature

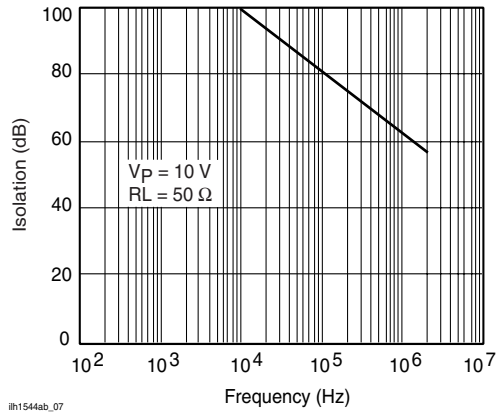

Figure 8. Output Isolation

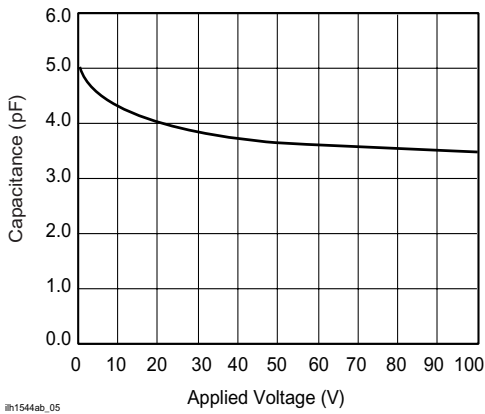

Figure 6. Switch Capacitance vs. Applied Voltage

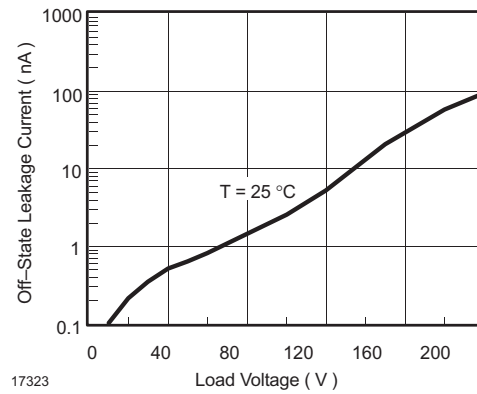

Figure 9. Leakage Current vs. Applied Voltage

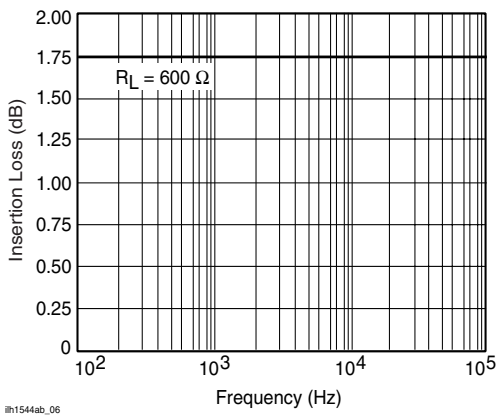

Figure 7. Insertion Loss vs. Frequency

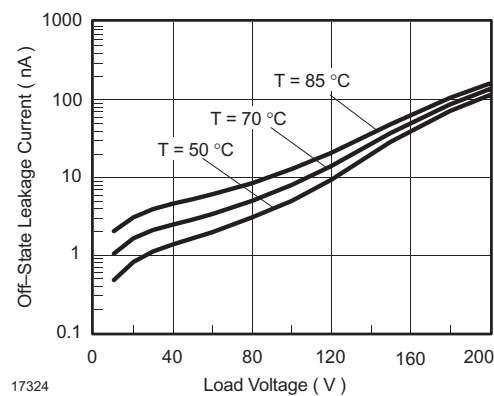
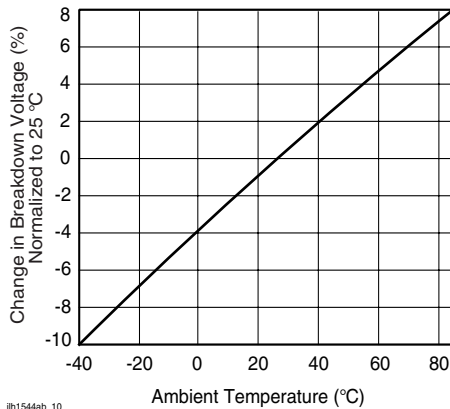
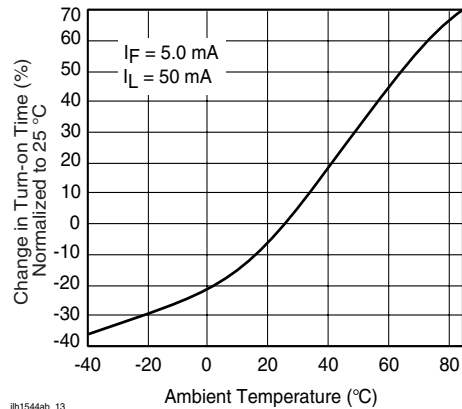

Figure 10. Leakage Current vs. Applied Voltage at Elevated Temperatures



ih1544ab_10

Figure 11. Switch Breakdown Voltage vs. Temperature



ih1544ab_13

Figure 14. Turn-on Time vs. Temperature

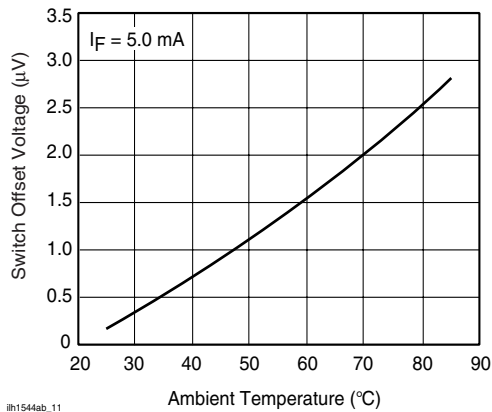

ih1544ab_11

Figure 12. Switch Offset Voltage vs. Temperature

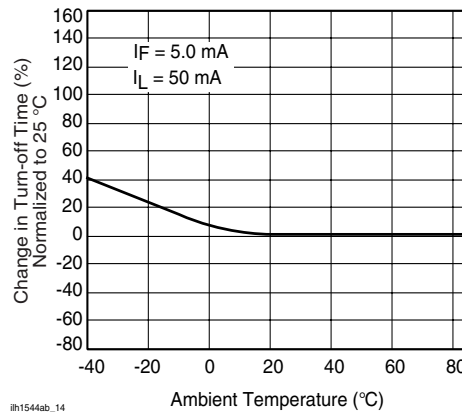

ih1544ab_14

Figure 15. Turn-off Time vs. Temperature

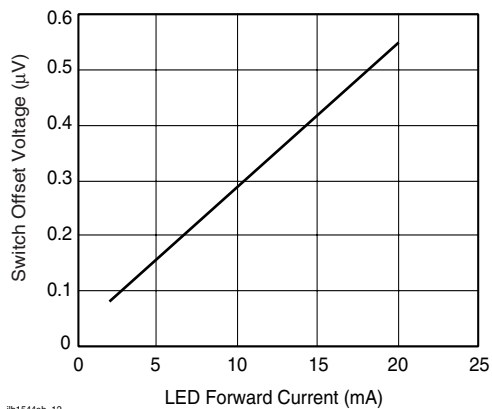

ih1544ab_12

Figure 13. Switch Offset Voltage vs. LED Current

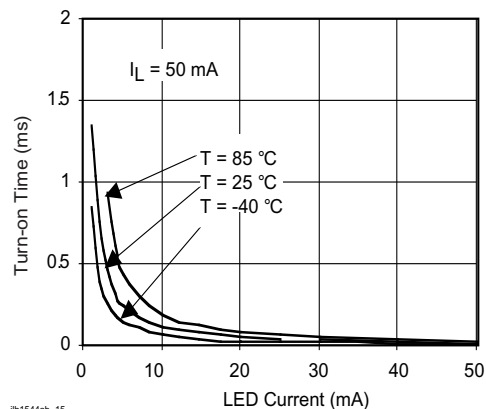

ih1544ab_15

Figure 16. Turn-on Time vs. LED Current

Figure 17. Turn-off Time vs. LED Current

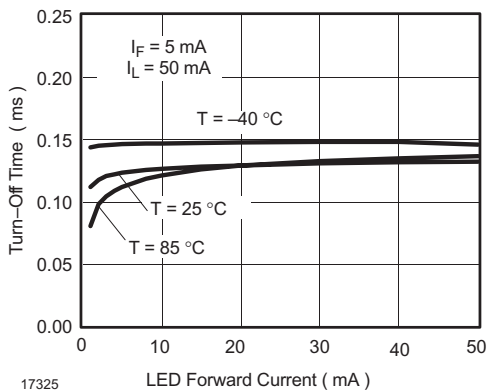

Package Dimensions in Inches (mm)

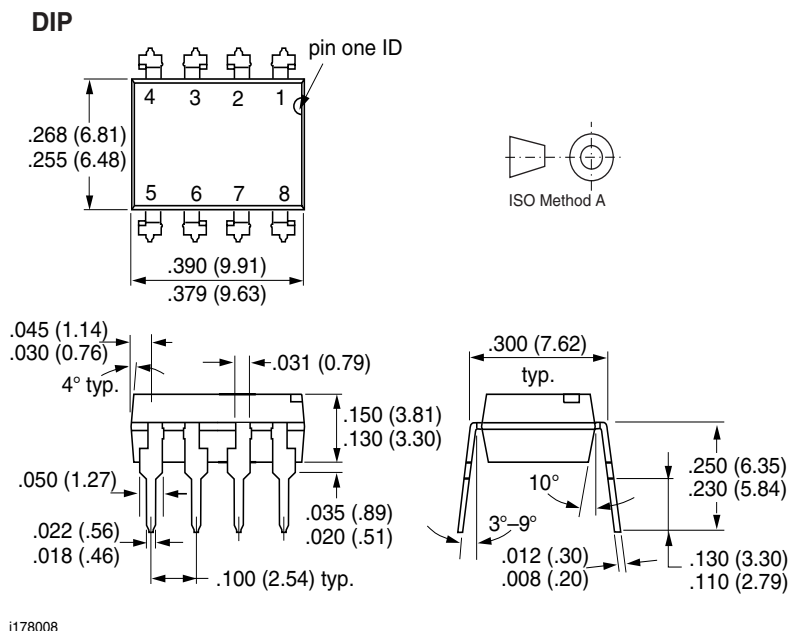

Package Dimensions in Inches (mm)

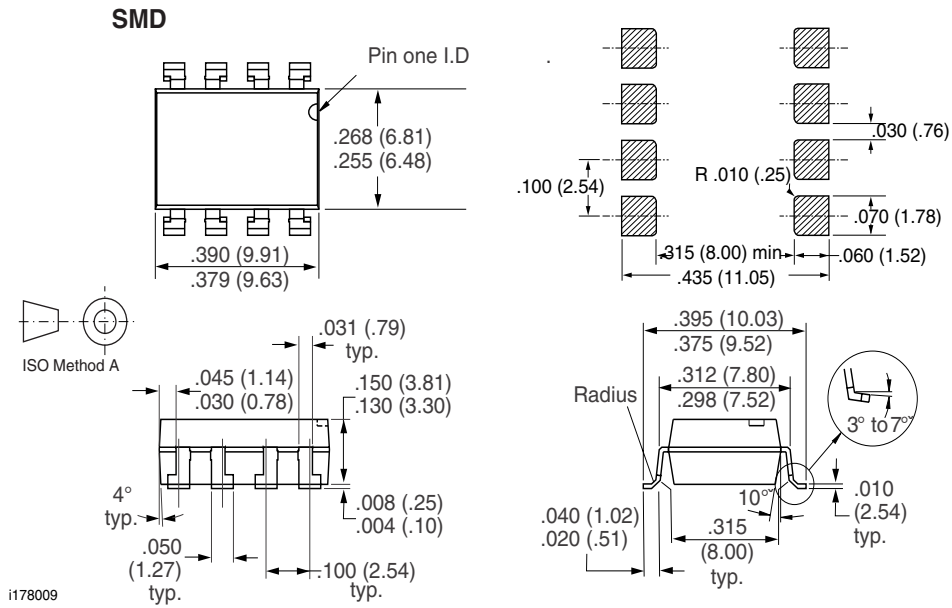

Ozone Depleting Substances Policy Statement

It is the policy of Vishay Semiconductor GmbH to

1. Meet all present and future national and international statutory requirements.
2. Regularly and continuously improve the performance of our products, processes, distribution and operating systems with respect to their impact on the health and safety of our employees and the public, as well as their impact on the environment.

It is particular concern to control or eliminate releases of those substances into the atmosphere which are known as ozone depleting substances (ODSs).

The Montreal Protocol (1987) and its London Amendments (1990) intend to severely restrict the use of ODSs and forbid their use within the next ten years. Various national and international initiatives are pressing for an earlier ban on these substances.

Vishay Semiconductor GmbH has been able to use its policy of continuous improvements to eliminate the use of ODSs listed in the following documents.

1. Annex A, B and list of transitional substances of the Montreal Protocol and the London Amendments respectively
2. Class I and II ozone depleting substances in the Clean Air Act Amendments of 1990 by the Environmental Protection Agency (EPA) in the USA
3. Council Decision 88/540/EEC and 91/690/EEC Annex A, B and C (transitional substances) respectively.

Vishay Semiconductor GmbH can certify that our semiconductors are not manufactured with ozone depleting substances and do not contain such substances.

We reserve the right to make changes to improve technical design
and may do so without further notice.

Parameters can vary in different applications. All operating parameters must be validated for each customer application by the customer. Should the buyer use Vishay Semiconductors products for any unintended or unauthorized application, the buyer shall indemnify Vishay Semiconductors against all claims, costs, damages, and expenses, arising out of, directly or indirectly, any claim of personal damage, injury or death associated with such unintended or unauthorized use.

Vishay Semiconductor GmbH, P.O.B. 3535, D-74025 Heilbronn, Germany
Telephone: 49 (0)7131 67 2831, Fax number: 49 (0)7131 67 2423