

Optocoupler, Photodarlington Output

Features

- High Isolation Test Voltage 5300 V_{RMS}
- Standard Plastic DIP-4 Package
- Lead-free component
- Component in accordance to RoHS 2002/95/EC and WEEE 2002/96/EC

Agency Approvals

- UL - File No. E52744 System Code H or J
- BSI IEC60950 IEC60065

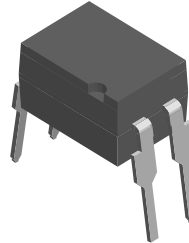

1179057

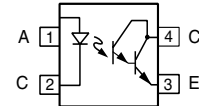

Description

The SFH612A and SFH655A are optically coupled isolators with a Gallium Arsenide infrared LED and a silicon photodarlington detector. Switching can be achieved while maintaining a high degree of isolation between driving and load circuits. These optocouplers can be used to replace reed and mercury relays with advantages of long life, high speed switching and elimination of magnetic fields.

Order Information

Part	Remarks
SFH612A	CTR > 200 %, DIP-4
SFH655A	CTR > 600 %, DIP-4
SFH655A-X009	CTR > 600 %, SMD-4 (option 9)

For additional information on the available options refer to Option Information.

Absolute Maximum Ratings

T_{amb} = 25 °C, unless otherwise specified

Stresses in excess of the absolute Maximum Ratings can cause permanent damage to the device. Functional operation of the device is not implied at these or any other conditions in excess of those given in the operational sections of this document. Exposure to absolute Maximum Rating for extended periods of the time can adversely affect reliability.

Input

Parameter	Test condition	Symbol	Value	Unit
Peak reverse voltage		V _{RM}	6.0	V
Forward continuous current		I _F	60	mA
Surge forward current	t _p ≥ 10 μs	I _{FSM}	2.5	A
Derate linearly from 25 °C			1.33	mW/°C
Power dissipation		P _{diss}	100	mW

Output

Parameter	Test condition	Symbol	Value	Unit
Collector-emitter breakdown voltage		BV_{CEO}	55	V
Emitter-collector breakdown voltage		BV_{ECO}	6.0	V
Collector (load) current		I_C	125	mA
Derate linearly from 25 °C			2.00	mW/°C
Power dissipation		P_{diss}	150	mW

Coupler

Parameter	Test condition	Symbol	Value	Unit
Derate linearly from 25 °C			3.33	mW/°C
Total power dissipation		P_{tot}	250	mW
Isolation test voltage between input and output, climate acc. to IEC 60068-1:1988	$t = 1.0$ s	V_{ISO}	5300	V_{RMS}
Creepage distance			≥ 7.0	mm
Clearance			≥ 7.0	mm
Comparative tracking index acc. to DIN IEC 112/VDE 0303, part 1:06-84			≥ 175	
Isolation resistance	$V_{IO} = 500$ V, $T_{amb} = 25$ °C	R_{IO}	$\geq 10^{12}$	Ω
	$V_{IO} = 500$ V, $T_{amb} = 100$ °C	R_{IO}	$\geq 10^{11}$	Ω
Storage temperature range		T_{stg}	- 55 to + 150	°C
Operating temperature range		T_{amb}	- 55 to + 100	°C
Soldering temperature	max. 10 s, dip soldering: distance to seating plane ≥ 1.5 mm		260	°C

Electrical Characteristics

$T_{amb} = 25$ °C, unless otherwise specified

Minimum and maximum values are testing requirements. Typical values are characteristics of the device and are the result of engineering evaluation. Typical values are for information only and are not part of the testing requirements.

Input

Parameter	Test condition	Symbol	Min	Typ.	Max	Unit
Forward voltage	$I_F = 10$ mA	V_F		1.15	1.5	V
Reverse current	$V_R = 6.0$ V	I_R		0.02	10	μ A
Capacitance	$V_R = 0$, $f = 1.0$ MHz	C_O		14		pF

Output

Parameter	Test condition	Symbol	Min	Typ.	Max	Unit
Collector-emitter breakdown voltage	$I_{CE} = 100$ μ A	BV_{CEO}	55			V
Emitter-collector breakdown voltage	$I_{EC} = 10$ μ A	BV_{ECO}	6.0			V
Collector-emitter dark current	$V_{CE} = 40$ V	I_{CEO}		12	400	nA
Collector-emitter capacitance	$V_{CE} = 0$ V, $f = 1.0$ MHz	C_{CE}		13.5		pF

Coupler

Parameter	Test condition	Part	Symbol	Min	Typ.	Max	Unit
Collector-emitter saturation voltage	$I_F = 1.0 \text{ mA}, I_C = 2.0 \text{ mA}$	SFH612A	V_{CEsat}			1.0	V
	$I_F = 20 \text{ mA}, I_C = 5.0 \text{ mA}$	SFH655A	V_{CEsat}			1.0	V
Coupling capacitance	$V_{I-O} = 0 \text{ V}, f = 1.0 \text{ MHz}$		C_C		0.45		pF

Current Transfer Ratio

Parameter	Test condition	Part	Symbol	Min	Typ.	Max	Unit
Current Transfer Ratio	$I_F = 1.0 \text{ mA}, V_{CE} = 2.0 \text{ V}$	SFH612A	CTR	200			%
		SFH655A	CTR	600			%

Switching Characteristics

Parameter	Test condition	Part	Symbol	Min	Typ.	Max	Unit
Turn-on time (Fig. 10, Test Circuit 1)	$V_{CC} = 10 \text{ V}, I_C = 2.0 \text{ mA}, R_L = 100 \Omega$	SFH612A	t_{on}		16		μs
Turn-off time (Fig. 10, Test Circuit 1)	$V_{CC} = 10 \text{ V}, I_C = 2.0 \text{ mA}, R_L = 100 \Omega$	SFH612A	t_{off}		15		μs
Rise time (Fig. 10, Test Circuit 1)	$V_{CC} = 10 \text{ V}, I_C = 2.0 \text{ mA}, R_L = 100 \Omega$	SFH612A	t_r		14		μs
Fall time (Fig. 10, Test Circuit 1)	$V_{CC} = 10 \text{ V}, I_C = 2.0 \text{ mA}, R_L = 100 \Omega$	SFH612A	t_f		14		μs
Turn-on time (Fig. 11, Test Circuit 2)	$V_{CC} = 2.0 \text{ V}, I_C = 10 \text{ mA}, R_L = 100 \Omega$	SFH655A	t_{on}		31		μs
Turn-off time (Fig. 11, Test Circuit 2)	$V_{CC} = 2.0 \text{ V}, I_C = 10 \text{ mA}, R_L = 100 \Omega$	SFH655A	t_{off}		55		μs
Rise time (Fig. 11, Test Circuit 2)	$V_{CC} = 2.0 \text{ V}, I_C = 10 \text{ mA}, R_L = 100 \Omega$	SFH655A	t_r		27	250	μs
Fall time (Fig. 11, Test Circuit 2)	$V_{CC} = 2.0 \text{ V}, I_C = 10 \text{ mA}, R_L = 100 \Omega$	SFH655A	t_f		56	200	μs

Typical Characteristics ($T_{amb} = 25^\circ\text{C}$ unless otherwise specified)

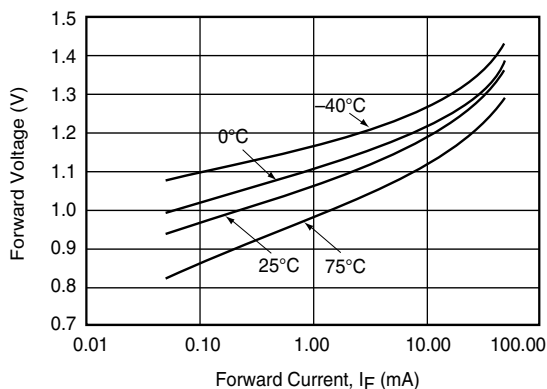

isfh612a_01

Figure 1. Forward Voltage vs. Forward Current

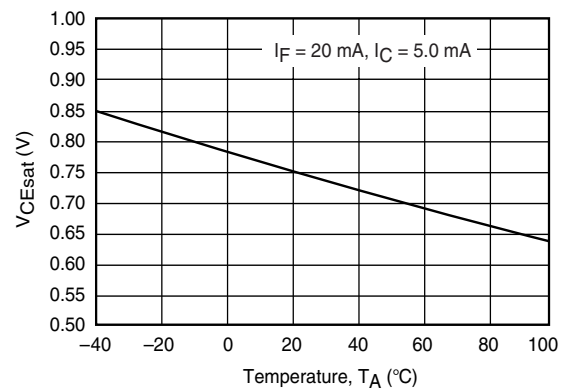

isfh612a_02

Figure 2. Collector Emitter Saturation Voltage vs. Temperature

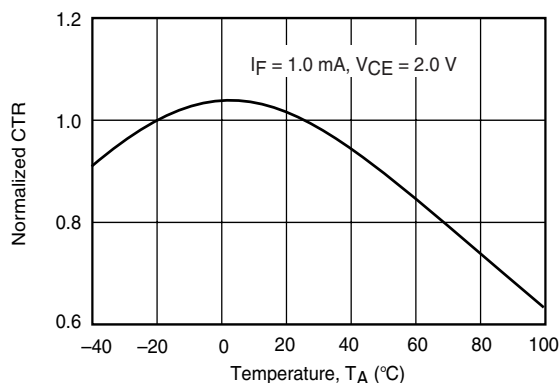

Figure 3. Normalized CTR vs. Temperature

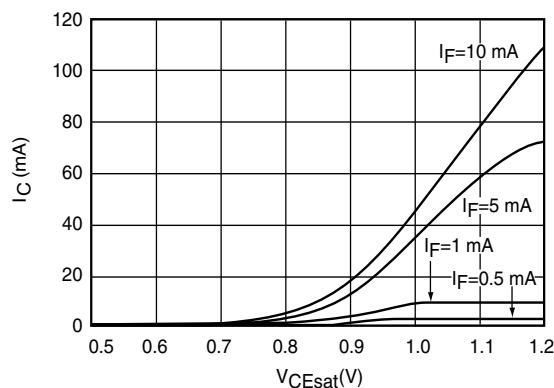

Figure 6. Collector Current vs. Collector-Emitter Saturation Voltage

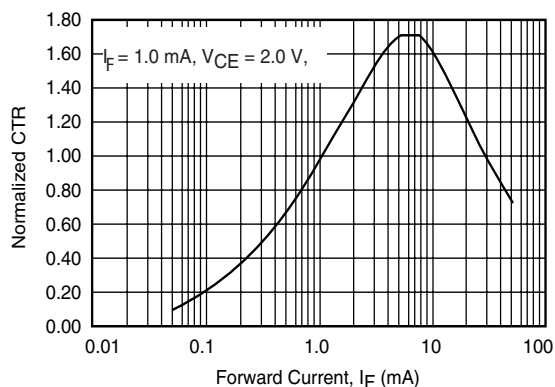

Figure 4. Normalized CTR vs. Forward Current

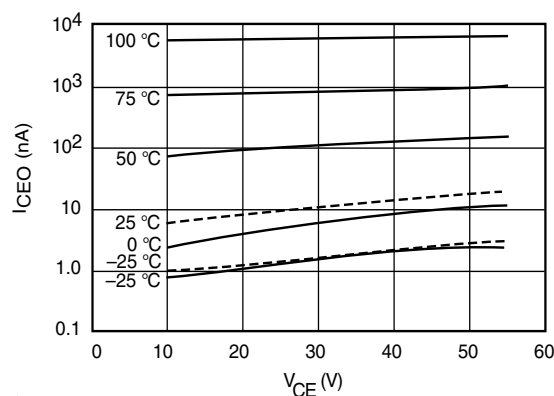

Figure 7. Collector-Emitter Dark Current vs. Collector-Emitter Voltage over Temperature

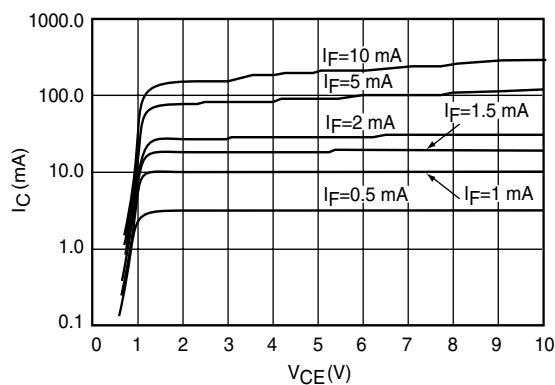

Figure 5. Collector Current vs. Collector Emitter Voltage

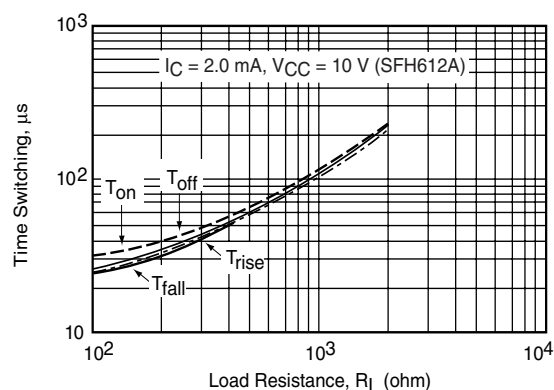
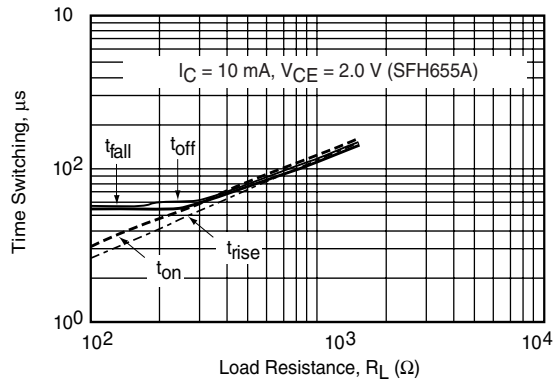
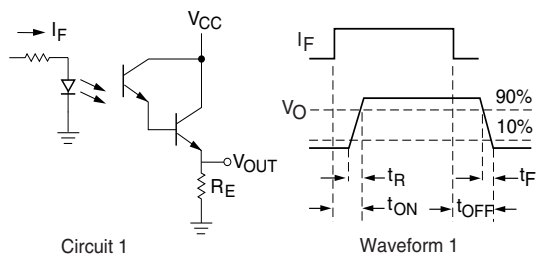

Figure 8. Switching Time vs. Load Resistor



isfh612a_09

Figure 9. Switching Time vs. Load Resistor



isfh612a_10

Figure 10. Switching Time Test Circuit and Waveforms

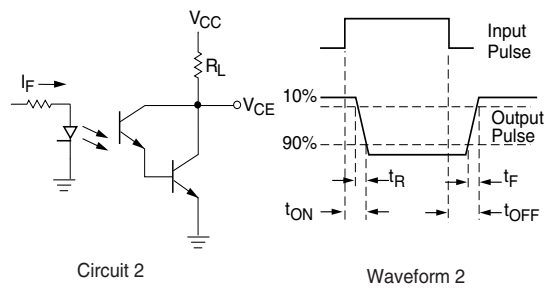

isfh612a_11

Figure 11. Switching Time Test Circuit and Waveforms

SFH612A/ SFH655A



Vishay Semiconductors

Package Dimensions in Inches (mm)

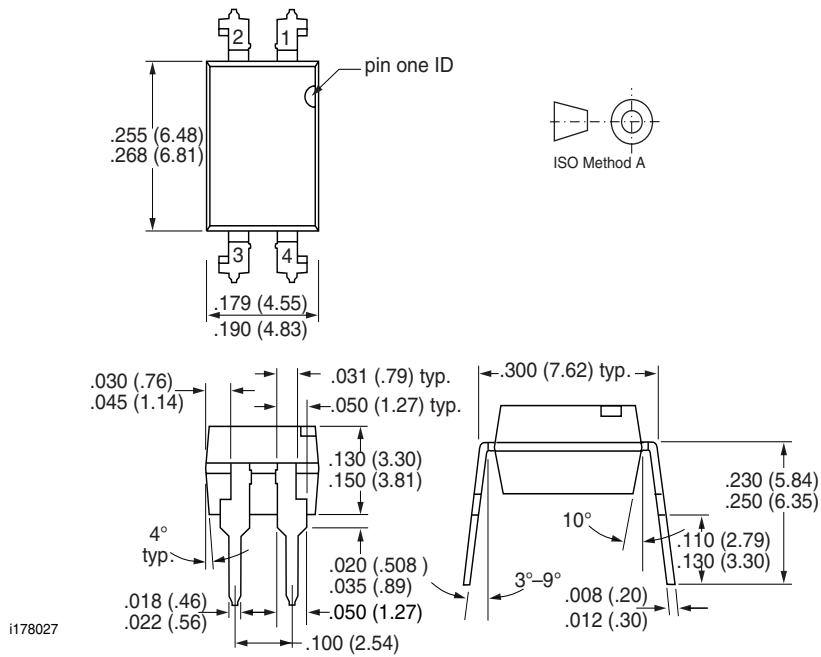

Option 9

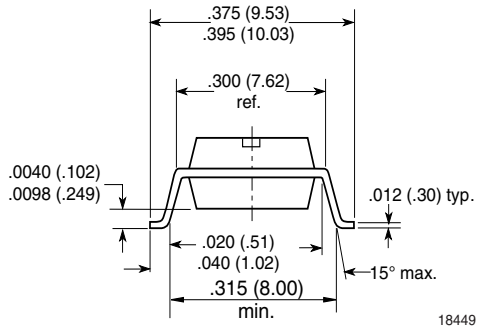



Ozone Depleting Substances Policy Statement

It is the policy of Vishay Semiconductor GmbH to

1. Meet all present and future national and international statutory requirements.
2. Regularly and continuously improve the performance of our products, processes, distribution and operating systems with respect to their impact on the health and safety of our employees and the public, as well as their impact on the environment.

It is particular concern to control or eliminate releases of those substances into the atmosphere which are known as ozone depleting substances (ODSs).

The Montreal Protocol (1987) and its London Amendments (1990) intend to severely restrict the use of ODSs and forbid their use within the next ten years. Various national and international initiatives are pressing for an earlier ban on these substances.

Vishay Semiconductor GmbH has been able to use its policy of continuous improvements to eliminate the use of ODSs listed in the following documents.

1. Annex A, B and list of transitional substances of the Montreal Protocol and the London Amendments respectively
2. Class I and II ozone depleting substances in the Clean Air Act Amendments of 1990 by the Environmental Protection Agency (EPA) in the USA
3. Council Decision 88/540/EEC and 91/690/EEC Annex A, B and C (transitional substances) respectively.

Vishay Semiconductor GmbH can certify that our semiconductors are not manufactured with ozone depleting substances and do not contain such substances.

We reserve the right to make changes to improve technical design and may do so without further notice.

Parameters can vary in different applications. All operating parameters must be validated for each customer application by the customer. Should the buyer use Vishay Semiconductors products for any unintended or unauthorized application, the buyer shall indemnify Vishay Semiconductors against all claims, costs, damages, and expenses, arising out of, directly or indirectly, any claim of personal damage, injury or death associated with such unintended or unauthorized use.

Vishay Semiconductor GmbH, P.O.B. 3535, D-74025 Heilbronn, Germany
Telephone: 49 (0)7131 67 2831, Fax number: 49 (0)7131 67 2423



Notice

Specifications of the products displayed herein are subject to change without notice. Vishay Intertechnology, Inc., or anyone on its behalf, assumes no responsibility or liability for any errors or inaccuracies.

Information contained herein is intended to provide a product description only. No license, express or implied, by estoppel or otherwise, to any intellectual property rights is granted by this document. Except as provided in Vishay's terms and conditions of sale for such products, Vishay assumes no liability whatsoever, and disclaims any express or implied warranty, relating to sale and/or use of Vishay products including liability or warranties relating to fitness for a particular purpose, merchantability, or infringement of any patent, copyright, or other intellectual property right.

The products shown herein are not designed for use in medical, life-saving, or life-sustaining applications. Customers using or selling these products for use in such applications do so at their own risk and agree to fully indemnify Vishay for any damages resulting from such improper use or sale.