

## Small Surface Mount Schottky Diodes

### Features

- For surface mounted applications
- Low-profile package
- Ideal for automated placement
- Low power loss, high efficiency
- High temperature soldering: 260 °C/10 seconds at terminals

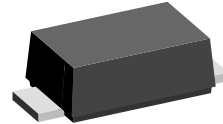

17249

### Mechanical Data

**Case:** JEDEC DO-219-AB (SMF) Plastic case

**Polarity:** Color band denotes cathode end

**Weight:** approx. 0.01g

### Packaging codes-options:

G1-10 K per 13 " reel (8 mm tape), 50 K/box

G2-3 K per 7 " reel (8 mm tape), 30 K/box

### Parts Table

Part	Type differentiation	Marking	Package
SL02	Single Diodes	S2	SMF
SL03	Single Diodes	S3	SMF
SL04	Single Diodes	S4	SMF

### Absolute Maximum Ratings

$T_{amb} = 25\text{ °C}$ , unless otherwise specified

Parameter	Test condition	Part	Symbol	Value	Unit
Maximum repetitive peak reverse voltage		SL02	$V_{RRM}$	20	V
		SL03	$V_{RRM}$	30	V
		SL04	$V_{RRM}$	40	V
Maximum RMS voltage		SL02	$V_{RMS}$	14	V
		SL03	$V_{RMS}$	21	V
		SL04	$V_{RMS}$	28	V
Maximum DC blocking voltage		SL02	$V_{DC}$	20	V
		SL03	$V_{DC}$	30	V
		SL04	$V_{DC}$	40	V
Maximum average forward rectified current	$T_{ip} = 109\text{ °C}$		$I_{F(AV)}$	1.1	A
Peak forward surge current 8.3 ms single half sine-wave			$I_{FSM}$	40	A

### Maximum Thermal Resistance

$T_{amb} = 25\text{ }^{\circ}\text{C}$ , unless otherwise specified

Parameter	Symbol	Value	Unit
Thermal resistance junction to ambient air <sup>2)</sup>	$R_{\theta JA}$	180	K/W
Maximum operating junction temperature	$T_J$	125	$^{\circ}\text{C}$
Storage temperature range	$T_{STG}$	- 55 to 150	$^{\circ}\text{C}$

<sup>2)</sup>Mounted on epoxy substrate with 3 x 3mm Cu pads ( $\geq 40\text{ }\mu\text{m}$  thick)

### Electrical Characteristics

$T_{amb} = 25\text{ }^{\circ}\text{C}$ , unless otherwise specified

Parameter	Test condition	Part	Symbol	Typ.	Max	Unit
Instantaneous forward voltage at 0.5 <sup>1)</sup>		SL02	$V_F$	0.360	0.385	V
		SL03	$V_F$	0.395	0.43	V
		SL04	$V_F$	0.450	0.51	V
Typical instantaneous forward voltage	1.1 A	SL02	$V_F$	0.420		V
	1.1 A	SL03	$V_F$	0.450		V
	1.1 A	SL04	$V_F$	0.530		V
Maximum DC reverse current at rated DC blocking voltage	$T_A = 25\text{ }^{\circ}\text{C}$	SL02	$I_R$		250	$\mu\text{A}$
	$T_A = 100\text{ }^{\circ}\text{C}$	SL02	$I_R$		8.0	mA
	$T_A = 25\text{ }^{\circ}\text{C}$	SL03	$I_R$		130	$\mu\text{A}$
	$T_A = 100\text{ }^{\circ}\text{C}$	SL03	$I_R$		6.0	mA
	$T_A = 25\text{ }^{\circ}\text{C}$	SL04	$I_R$		20	$\mu\text{A}$
	$T_A = 100\text{ }^{\circ}\text{C}$	SL04	$I_R$		6.0	mA

<sup>1)</sup> Pulse test: 300  $\mu\text{s}$  pulse width, 1 % duty cycle

### Typical Characteristics ( $T_{amb} = 25\text{ }^{\circ}\text{C}$ unless otherwise specified)

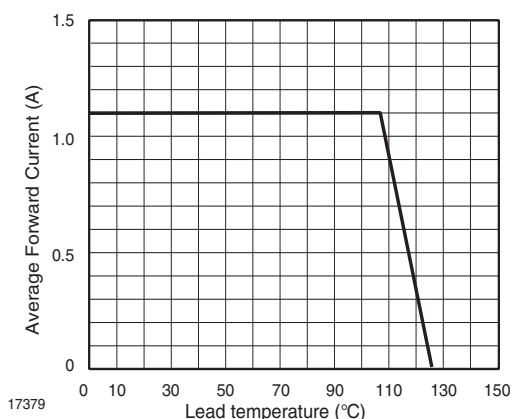

Figure 1. Forward Current Derating Curve

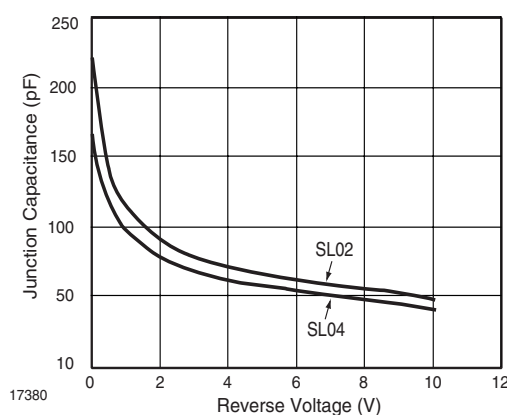

Figure 2. Typical Junction Capacitance

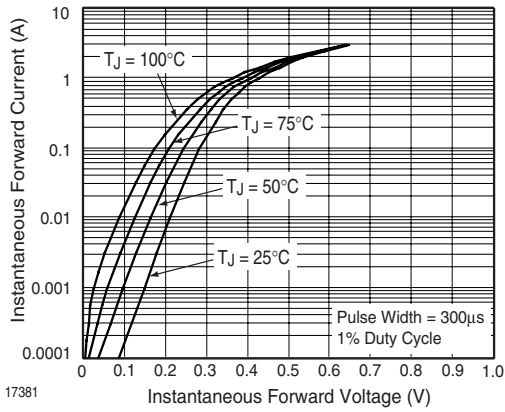

Figure 3. Typical Instantaneous Forward Characteristics - SL02

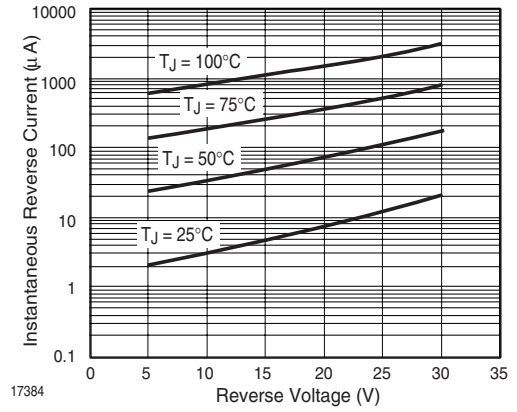

Figure 6. Typical Reverse Current Characteristics - SL03

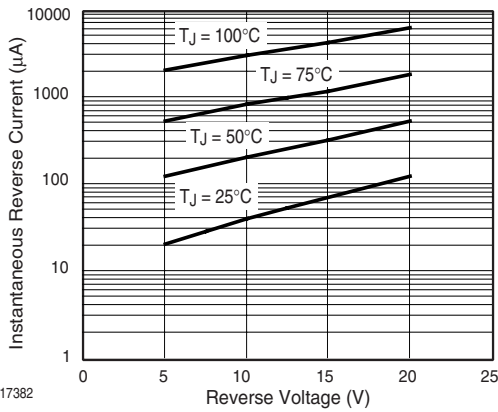

Figure 4. Typical Reverse Current Characteristics - SL02

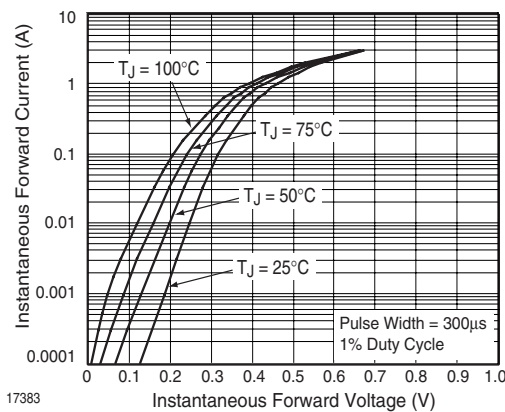

Figure 5. Typical Instantaneous Forward Characteristics - SL03

# SL02 to SL04

Vishay Semiconductors



## Package Dimensions in mm

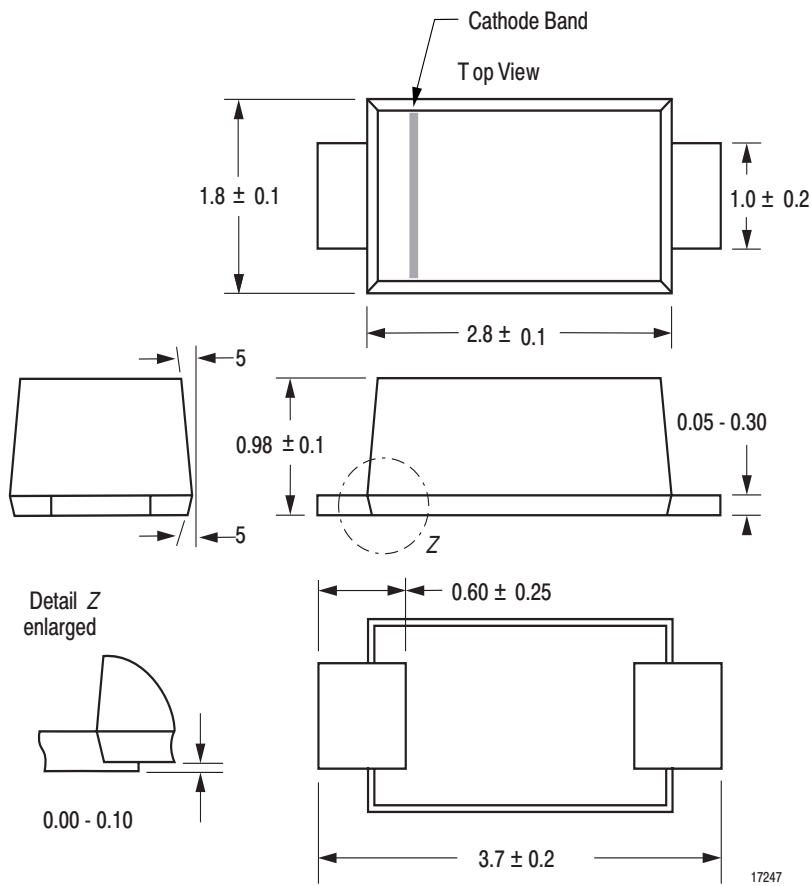

## Mounting Pad Layout

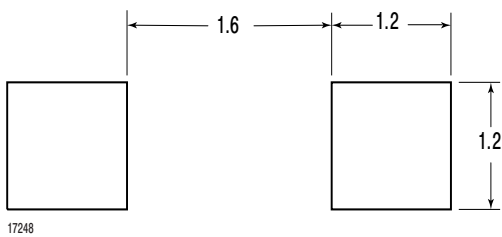



## Ozone Depleting Substances Policy Statement

It is the policy of **Vishay Semiconductor GmbH** to

1. Meet all present and future national and international statutory requirements.
2. Regularly and continuously improve the performance of our products, processes, distribution and operating systems with respect to their impact on the health and safety of our employees and the public, as well as their impact on the environment.

It is particular concern to control or eliminate releases of those substances into the atmosphere which are known as ozone depleting substances (ODSs).

The Montreal Protocol (1987) and its London Amendments (1990) intend to severely restrict the use of ODSs and forbid their use within the next ten years. Various national and international initiatives are pressing for an earlier ban on these substances.

**Vishay Semiconductor GmbH** has been able to use its policy of continuous improvements to eliminate the use of ODSs listed in the following documents.

1. Annex A, B and list of transitional substances of the Montreal Protocol and the London Amendments respectively
2. Class I and II ozone depleting substances in the Clean Air Act Amendments of 1990 by the Environmental Protection Agency (EPA) in the USA
3. Council Decision 88/540/EEC and 91/690/EEC Annex A, B and C (transitional substances) respectively.

**Vishay Semiconductor GmbH** can certify that our semiconductors are not manufactured with ozone depleting substances and do not contain such substances.

**We reserve the right to make changes to improve technical design  
and may do so without further notice.**

Parameters can vary in different applications. All operating parameters must be validated for each customer application by the customer. Should the buyer use Vishay Semiconductors products for any unintended or unauthorized application, the buyer shall indemnify Vishay Semiconductors against all claims, costs, damages, and expenses, arising out of, directly or indirectly, any claim of personal damage, injury or death associated with such unintended or unauthorized use.

Vishay Semiconductor GmbH, P.O.B. 3535, D-74025 Heilbronn, Germany  
Telephone: 49 (0)7131 67 2831, Fax number: 49 (0)7131 67 2423