

Cool MOS™ Power Transistor



Feature

- New revolutionary high voltage technology
- Ultra low gate charge
- Periodic avalanche rated
- Extreme dv/dt rated
- Ultra low effective capacitances
- Improved noise immunity

Product Summary

V_{DS}	800	V
$R_{DS(on)}$	900	m Ω
I_D	6	A

P-TO220-3-1

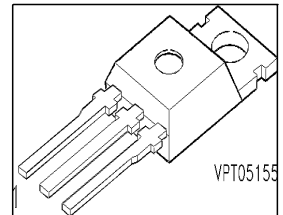

Type	Package	Ordering Code	Marking
SPP06N80C2	P-TO220-3-1	Q67040-S4351	SPP06N80C2

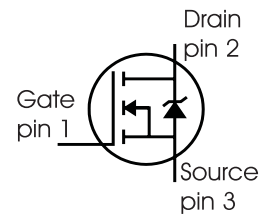

Maximum Ratings, at $T_j = 25\text{ }^\circ\text{C}$, unless otherwise specified

Parameter	Symbol	Value	Unit
Continuous drain current	I_D	6	A
$T_C = 25\text{ }^\circ\text{C}$		6	
$T_C = 100\text{ }^\circ\text{C}$		3.8	
Pulsed drain current, t_p limited by T_{jmax}	$I_{D\text{ puls}}$	18	
Avalanche energy, single pulse	E_{AS}	230	mJ
$I_D=1.5\text{A}, V_{DD}=50\text{V}$			
Avalanche energy, repetitive t_{AR} limited by T_{jmax} ¹⁾	E_{AR}	0.2	
$I_D=6\text{A}, V_{DD}=50\text{V}$			
Avalanche current, repetitive t_{AR} limited by T_{jmax}	I_{AR}	6	A
Reverse diode dv/dt	dv/dt	6	V/ns
$I_S=6\text{A}, V_{DS} < V_{DD}, di/dt=100\text{A}/\mu\text{s}, T_{jmax}=150\text{ }^\circ\text{C}$			
Gate source voltage	V_{GS}	± 20	V
Power dissipation	P_{tot}	83	W
$T_C = 25\text{ }^\circ\text{C}$			
Operating and storage temperature	T_j, T_{stg}	-55... +150	$^\circ\text{C}$

Thermal Characteristics

Parameter	Symbol	Values			Unit
		min.	typ.	max.	
Characteristics					
Thermal resistance, junction - case	R_{thJC}	-	-	1.5	K/W
Thermal resistance, junction - ambient, leaded	R_{thJA}	-	-	62	
Linear derating factor		-	-	0.67	W/K
Soldering temperature, 1.6 mm (0.063 in.) from case for 10s	T_{sold}	-	-	260	°C

Electrical Characteristics, at $T_j = 25\text{ °C}$, unless otherwise specified

Static Characteristics

Drain-source breakdown voltage $V_{GS}=0V, I_D=0.25mA$	$V_{(BR)DSS}$	800	-	-	V
Drain-source avalanche breakdown voltage $V_{GS}=0V, I_D=6A$	$V_{(BR)DS}$	-	870	-	
Gate threshold voltage, $V_{GS} = V_{DS}$ $I_D=250\mu A$	$V_{GS(th)}$	2	3	4	
Zero gate voltage drain current $V_{DS} = 800\text{ V}, V_{GS} = 0\text{ V}, T_j = 25\text{ °C}$ $V_{DS} = 800\text{ V}, V_{GS} = 0\text{ V}, T_j = 150\text{ °C}$	I_{DSS}	-	0.5	10	μA
		-	-	100	
Gate-source leakage current $V_{GS}=20V, V_{DS}=0V$	I_{GSS}	-	-	100	nA
Drain-source on-state resistance $V_{GS}=10V, I_D=3.8A, T_j=25\text{ °C}$	$R_{DS(on)}$	-	780	900	m Ω
Gate input resistance $f = 1\text{ MHz}, \text{open drain}$	R_G	-	0.7	-	Ω

¹Repetitive avalanche causes additional power losses that can be calculated as $P_{AV}=E_{AR} \cdot f$.

Electrical Characteristics , at $T_j = 25\text{ }^\circ\text{C}$, unless otherwise specified

Parameter	Symbol	Conditions	Values			Unit
			min.	typ.	max.	
Characteristics						
Transconductance	g_{fs}	$V_{DS} \geq 2 \cdot I_D \cdot R_{DS(on)max}$, $I_D = 3.8\text{A}$	-	4	-	S
Input capacitance	C_{iss}	$V_{GS} = 0\text{V}$, $V_{DS} = 25\text{V}$,	-	785	-	pF
Output capacitance	C_{oss}	$f = 1\text{MHz}$	-	390	-	
Reverse transfer capacitance	C_{rss}		-	20	-	
Effective output capacitance, ¹⁾ energy related	$C_{o(er)}$	$V_{GS} = 0\text{V}$, $V_{DS} = 0\text{V to } 640\text{V}$	-	22	-	pF
Effective output capacitance, ²⁾ time related	$C_{o(tr)}$		-	42	-	
Turn-on delay time	$t_{d(on)}$	$V_{DD} = 400\text{V}$, $V_{GS} = 0/10\text{V}$,	-	25	-	ns
Rise time	t_r	$I_D = 6\text{A}$, $R_G = 12\Omega$,	-	15	-	
Turn-off delay time	$t_{d(off)}$	$T_f = 125^\circ\text{C}$	-	48	60	
Fall time	t_f		-	8	13	

Gate Charge Characteristics

Gate to source charge	Q_{gs}	$V_{DD} = 640\text{V}$, $I_D = 6\text{A}$	-	2.5	-	nC
Gate to drain charge	Q_{gd}		-	9.8	-	
Gate charge total	Q_g	$V_{DD} = 640\text{V}$, $I_D = 6\text{A}$, $V_{GS} = 0\text{ to } 10\text{V}$	-	19.4	25	
Gate plateau voltage	$V_{(plateau)}$	$V_{DD} = 640\text{V}$, $I_D = 6\text{A}$	-	6	-	V

¹ $C_{o(er)}$ is a fixed capacitance that gives the same stored energy as C_{oss} while V_{DS} is rising from 0 to 80% V_{DSS} .

² $C_{o(tr)}$ is a fixed capacitance that gives the same charging time as C_{oss} while V_{DS} is rising from 0 to 80% V_{DSS} .

Electrical Characteristics, at $T_j = 25\text{ }^\circ\text{C}$, unless otherwise specified

Parameter	Symbol	Conditions	Values			Unit
			min.	typ.	max.	
Reverse Diode						
Inverse diode continuous forward current	I_S	$T_C=25^\circ\text{C}$	-	-	6	A
Inverse diode direct current, pulsed	I_{SM}		-	-	18	
Inverse diode forward voltage	V_{SD}	$V_{GS}=0\text{V}, I_F=I_S$	-	1	1.2	V
Reverse recovery time	t_{rr}	$V_R=400\text{V}, I_F=I_S,$	-	520	-	ns
Reverse recovery charge	Q_{rr}	$di_F/dt=100\text{A}/\mu\text{s}$	-	5	-	μC
Peak reverse recovery current	I_{rrm}		-	17	-	A
Peak rate of fall of reverse recovery current	di_{rr}/dt		-	400	-	$\text{A}/\mu\text{s}$

Transient Thermal Characteristics

Symbol	Value	Unit	Symbol	Value	Unit
	typ.			typ.	

Transient thermal impedance

Thermal resistance			Thermal capacitance		
R_{th1}	0.023	K/W	C_{th1}	0.000135	Ws/K
R_{th2}	0.033		C_{th2}	0.000438	
R_{th3}	0.067		C_{th3}	0.000313	
R_{th4}	0.189		C_{th4}	0.00149	
R_{th5}	0.208		C_{th5}	0.00738	
R_{th6}	0.076		C_{th6}	0.068	

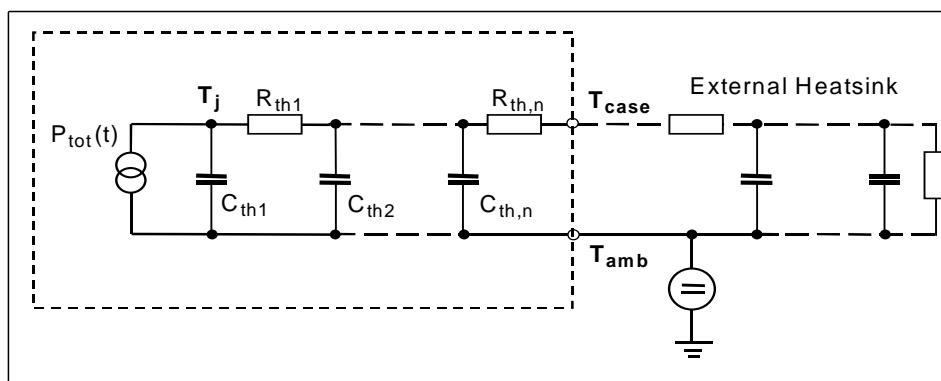

1 Power dissipation

$$P_{tot} = f(T_C)$$

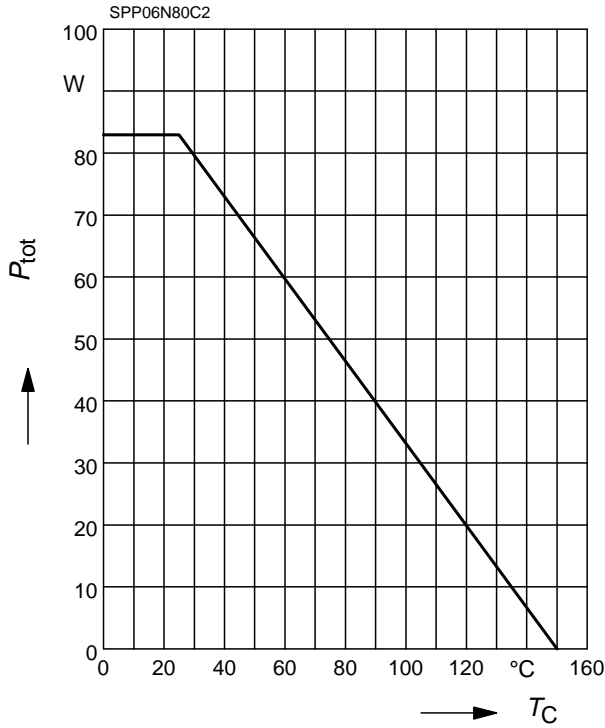

2 Drain current

$$I_D = f(T_C)$$

parameter: $V_{GS} \geq 10 \text{ V}$

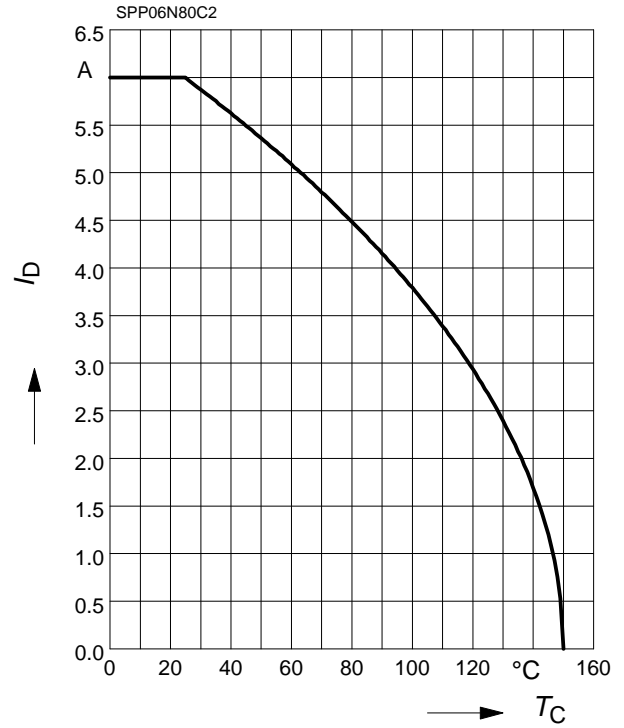

3 Safe operating area

$$I_D = f(V_{DS})$$

parameter: $D = 0$, $T_C = 25^\circ\text{C}$

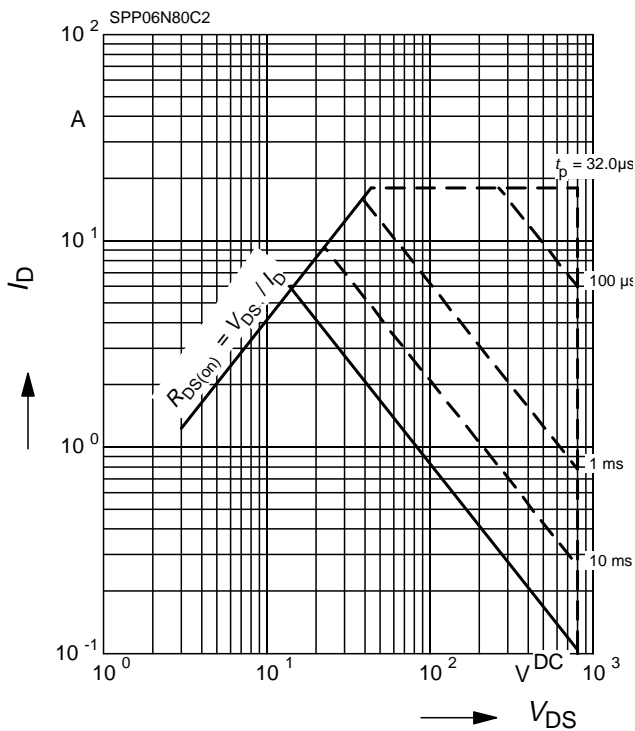

4 Transient thermal impedance

$$Z_{thJC} = f(t_p)$$

parameter: $D = t_p/T$

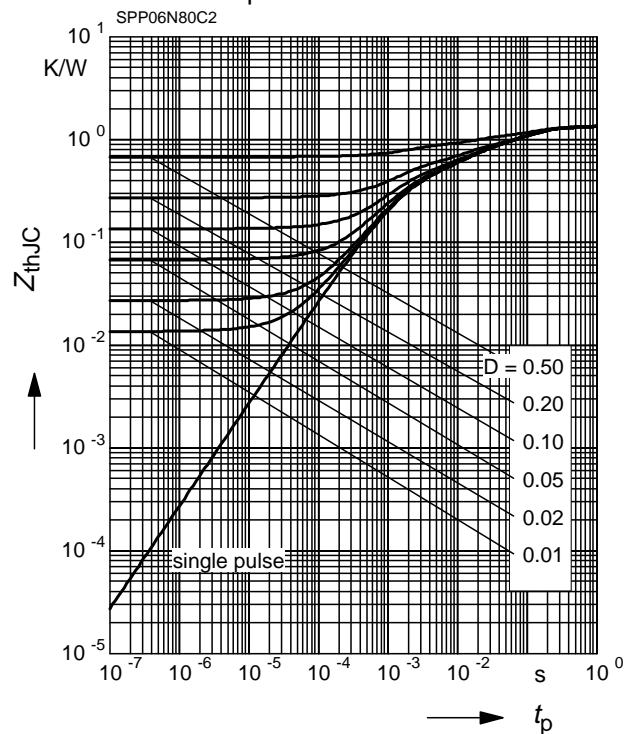

5 Typ. output characteristic

$I_D = f(V_{DS}); T_J = 25^\circ\text{C}$

parameter: $t_p = 10 \mu\text{s}, V_{GS}$

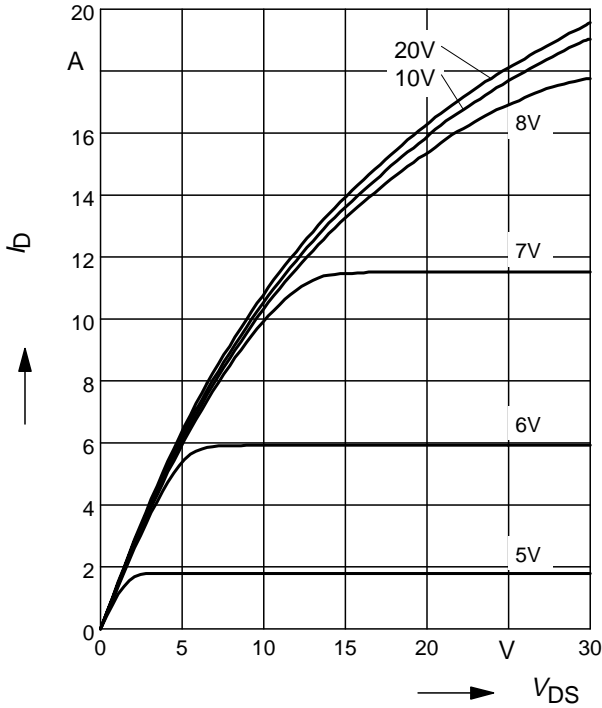

6 Typ. output characteristic

$I_D = f(V_{DS}); T_J = 150^\circ\text{C}$

parameter: $t_p = 10 \mu\text{s}, V_{GS}$

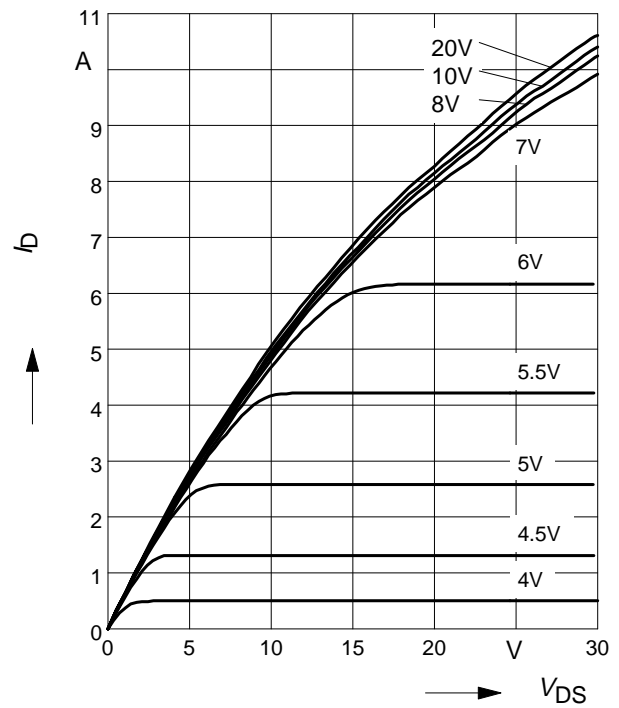

7 Typ. drain-source on resistance

$R_{DS(on)} = f(I_D)$

parameter: $T_J = 150^\circ\text{C}, V_{GS}$

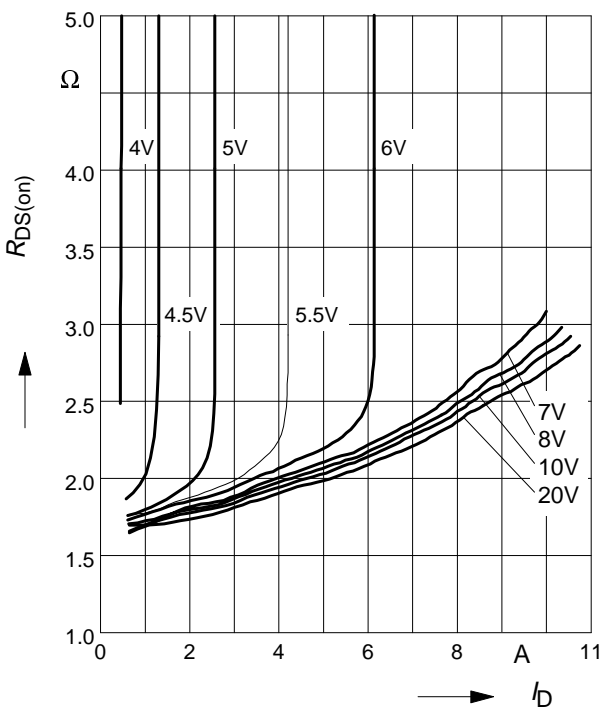

8 Drain-source on-state resistance

$R_{DS(on)} = f(T_J)$

parameter: $I_D = 3.8 \text{ A}, V_{GS} = 10 \text{ V}$

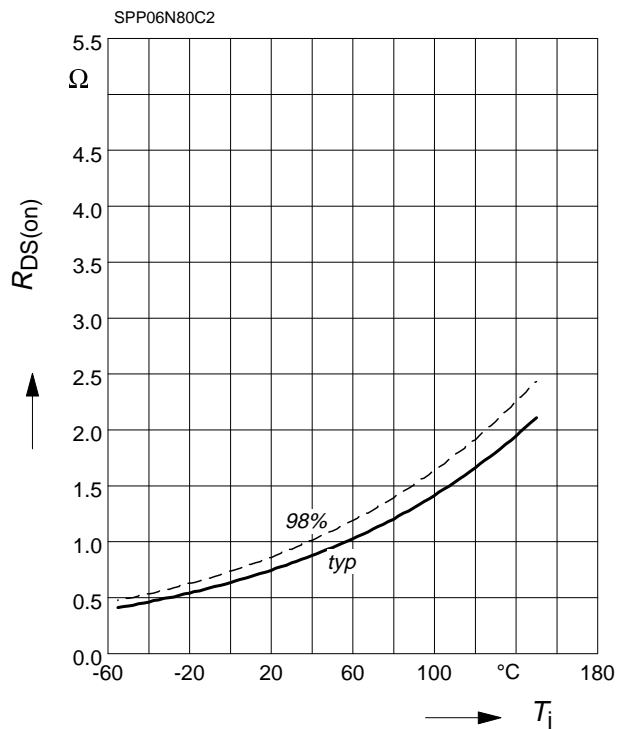

9 Typ. transfer characteristics

$I_D = f(V_{GS})$; $V_{DS} \geq 2 \times I_D \times R_{DS(on)max}$
 parameter: $t_p = 10 \mu s$

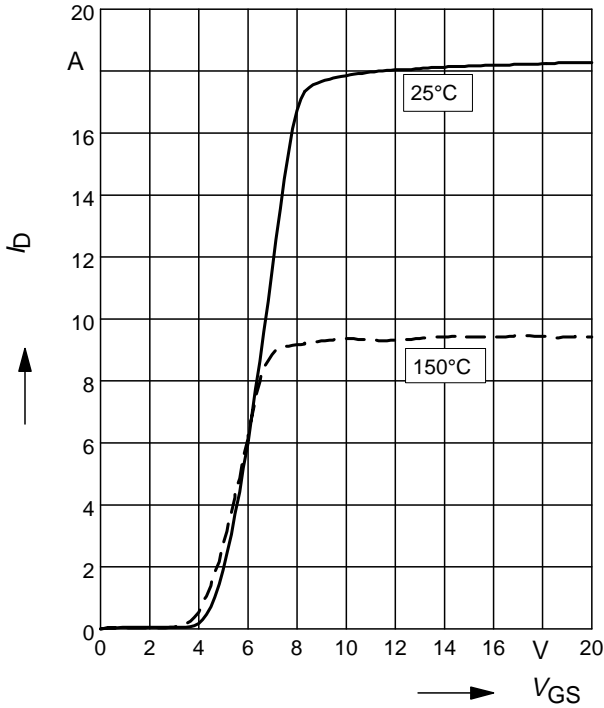

10 Gate threshold voltage

$V_{GS(th)} = f(T_j)$
 parameter: $V_{GS} = V_{DS}$, $I_D = 250 \mu A$

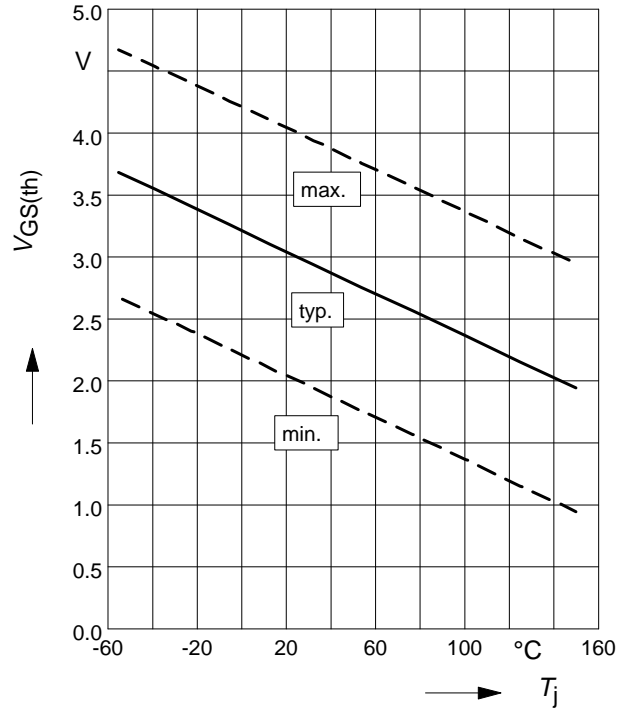

11 Typ. gate charge

$V_{GS} = f(Q_{Gate})$
 parameter: $I_D = 6 A$ pulsed

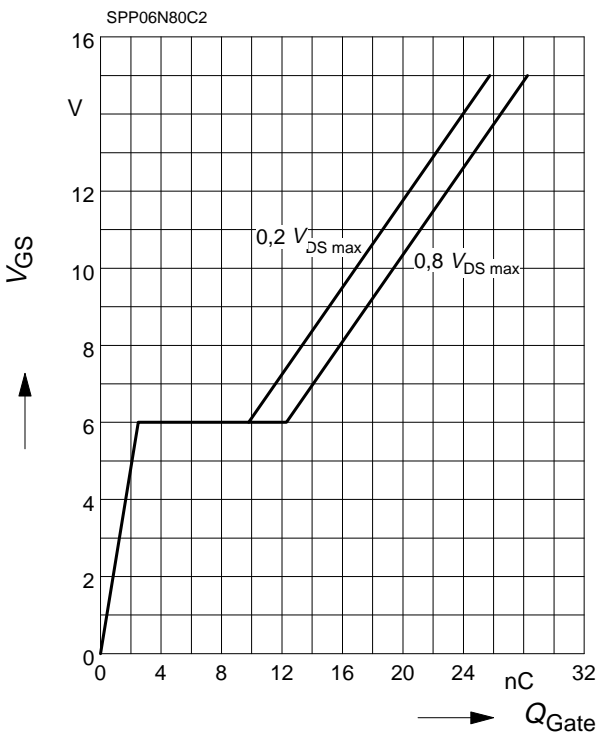

12 Forward characteristics of body diode

$I_F = f(V_{SD})$
 parameter: T_j , $t_p = 10 \mu s$

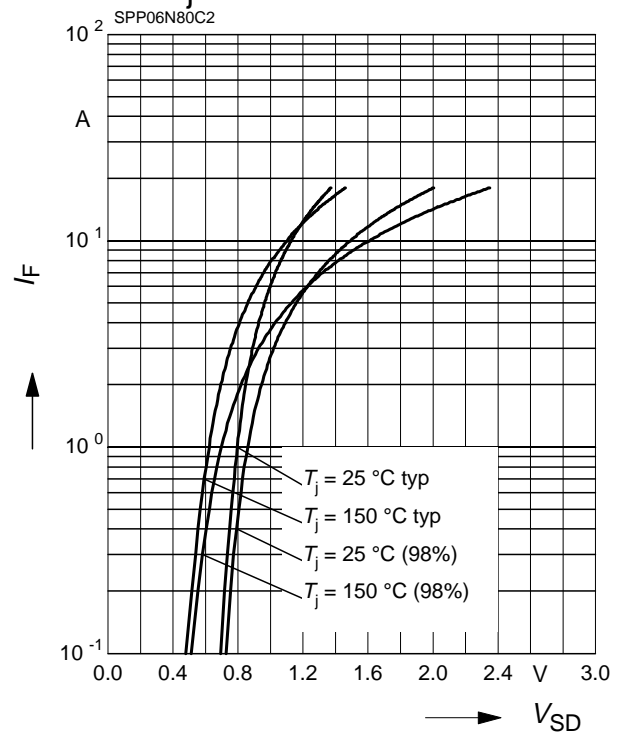

13 Avalanche SOA

$$I_{AR} = f(t_{AR})$$

par.: $T_j \leq 150\text{ }^\circ\text{C}$

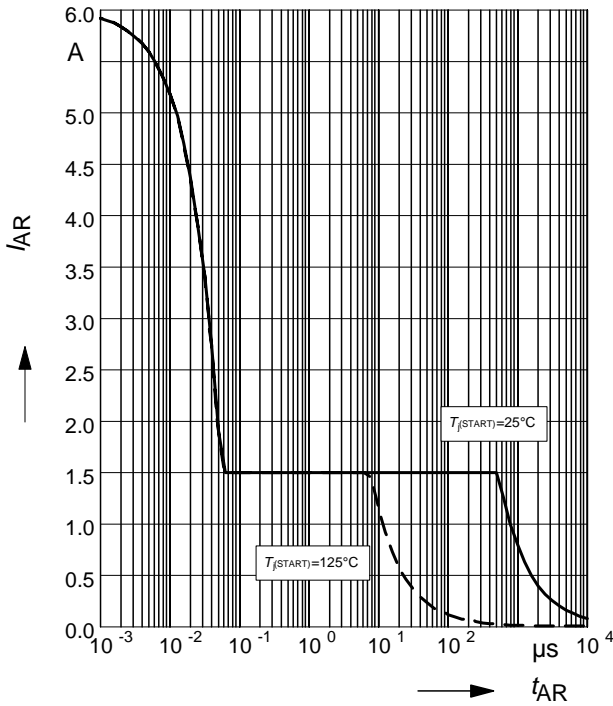

14 Avalanche energy

$$E_{AS} = f(T_j)$$

par.: $I_D = 1.5\text{ A}$, $V_{DD} = 50\text{ V}$

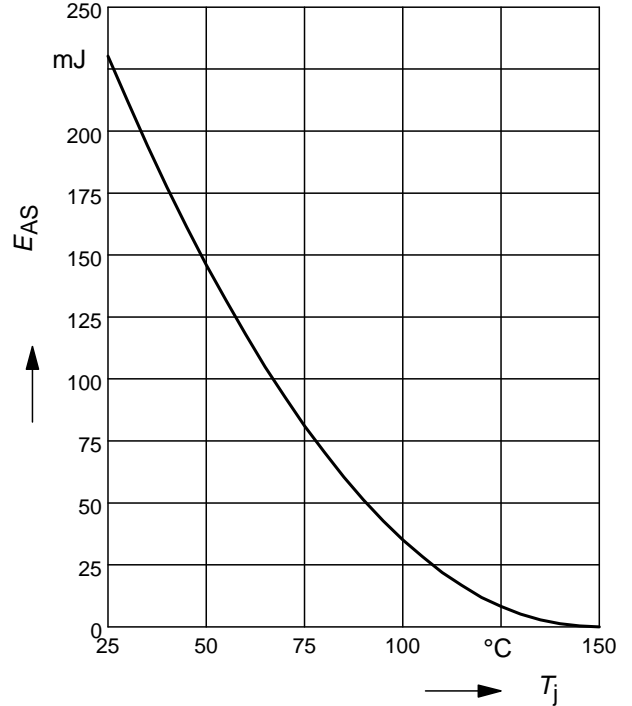

15 Drain-source breakdown voltage

$$V_{(BR)DSS} = f(T_j)$$

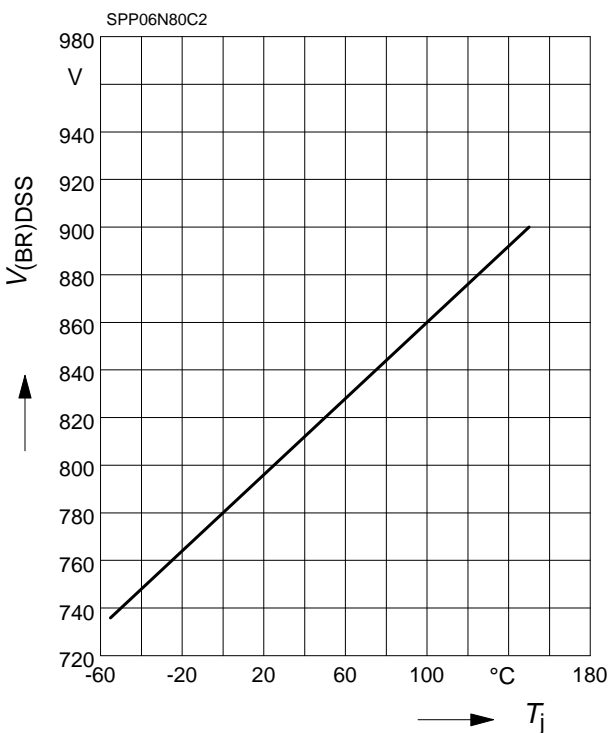

16 Avalanche power losses

$$P_{AR} = f(f)$$

parameter: $E_{AR} = 0.2\text{ mJ}$

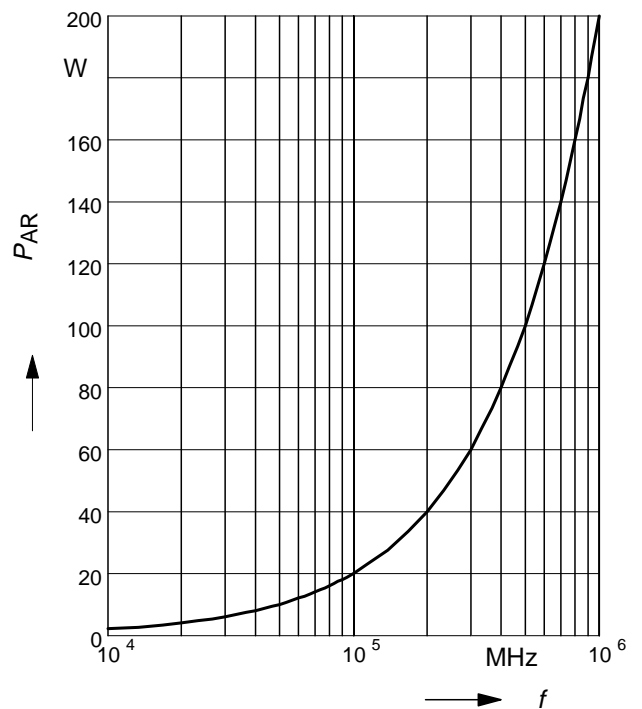

17 Typ. capacitances

$$C = f(V_{DS})$$

parameter: $V_{GS}=0V, f=1\text{ MHz}$

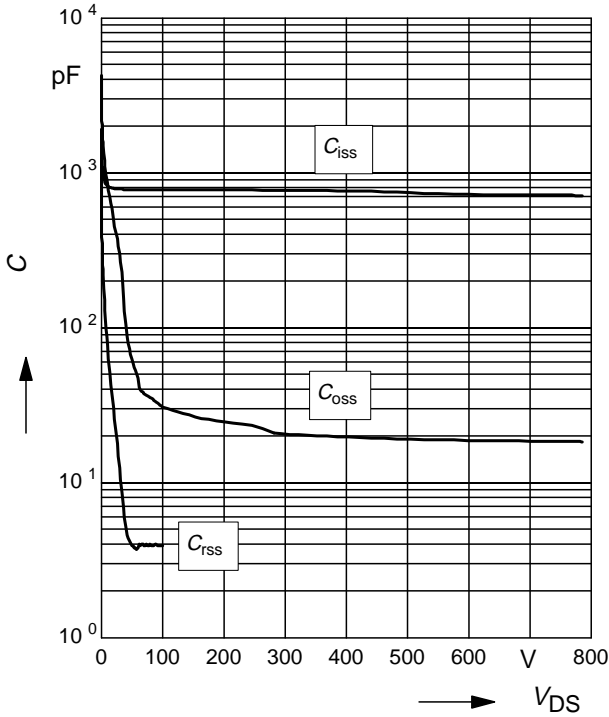

18 Typ. C_{oss} stored energy

$$E_{oss} = f(V_{DS})$$

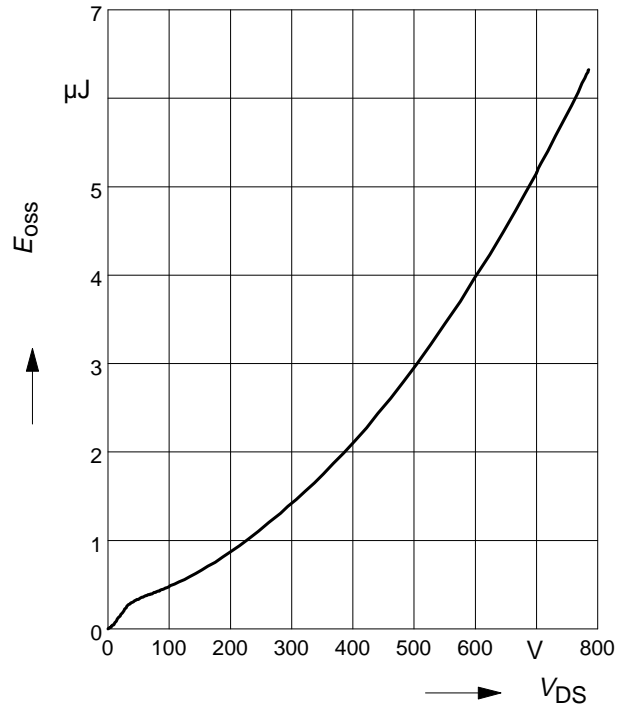

Definition of diodes switching characteristics

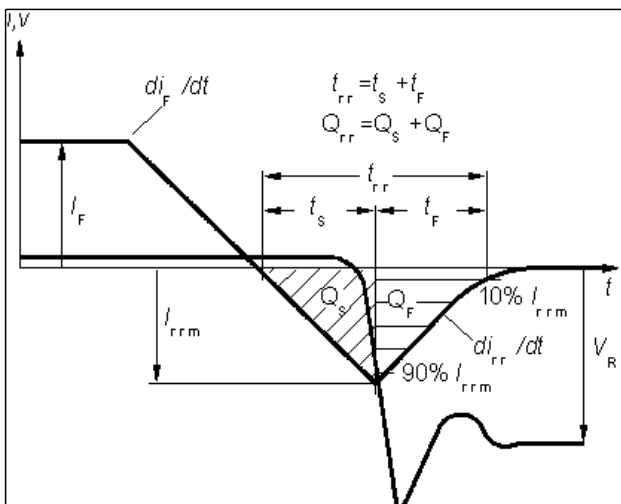

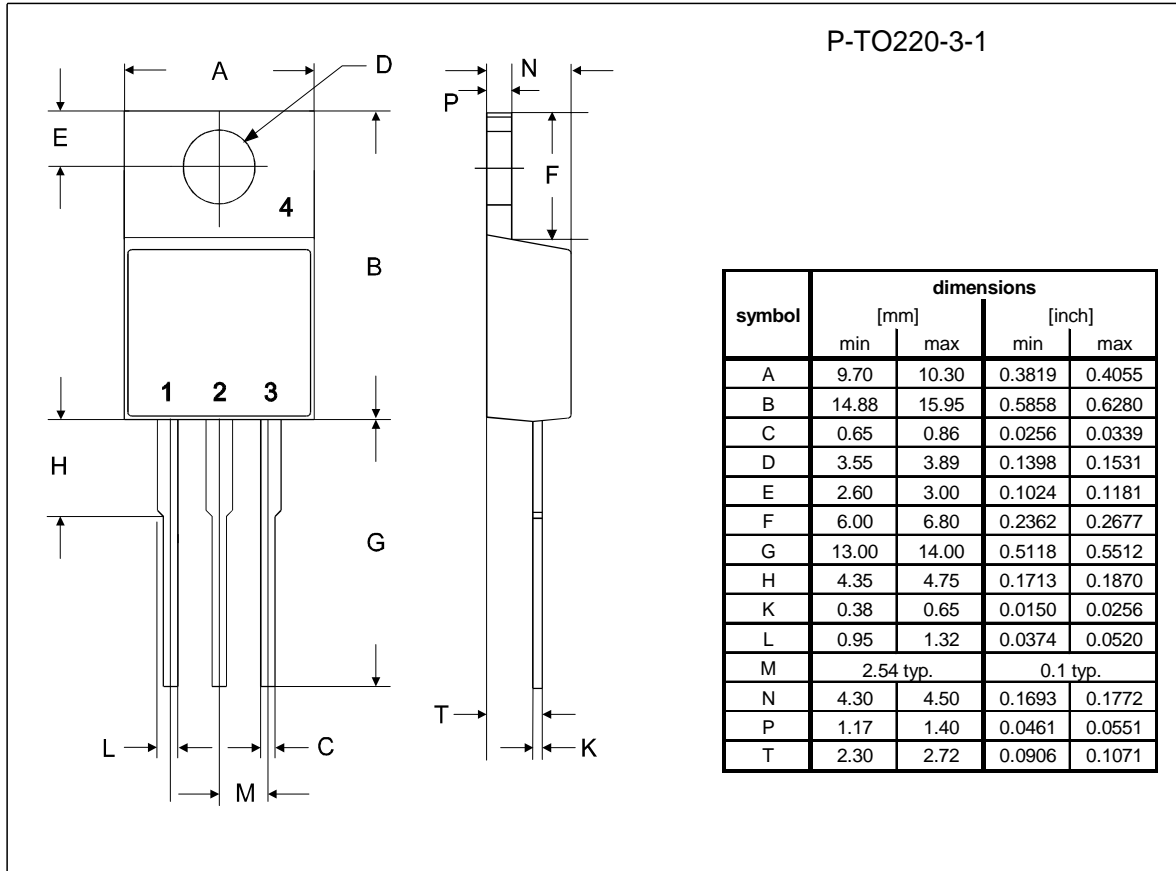

Published by

**Infineon Technologies AG,
Bereichs Kommunikation
St.-Martin-Strasse 53,
D-81541 München
© Infineon Technologies AG 1999
All Rights Reserved.**

Attention please!

The information herein is given to describe certain components and shall not be considered as warranted characteristics.

Terms of delivery and rights to technical change reserved.

We hereby disclaim any and all warranties, including but not limited to warranties of non-infringement, regarding circuits, descriptions and charts stated herein.

Infineon Technologies is an approved CECC manufacturer.

Information

For further information on technology, delivery terms and conditions and prices please contact your nearest Infineon Technologies Office in Germany or our Infineon Technologies Representatives worldwide (see address list).

Warnings

Due to technical requirements components may contain dangerous substances.

For information on the types in question please contact your nearest Infineon Technologies Office.

Infineon Technologies Components may only be used in life-support devices or systems with the express written approval of Infineon Technologies, if a failure of such components can reasonably be expected to cause the failure of that life-support device or system, or to affect the safety or effectiveness of that device or system. Life support devices or systems are intended to be implanted in the human body, or to support and/or maintain and sustain and/or protect human life. If they fail, it is reasonable to assume that the health of the user or other persons may be endangered.