

High Brightness Type Chip LEDs with reflector

SML-01 * Series

Package Size (mm)	Blue		Green		Yellow		Orange		Red		
	GaN on SiC	InGaN on SiC				AlGaInP on GaAs					
	428nm	468nm	525nm		590nm		611nm		630nm		
3216 (1206) 3.0×2.0 t=1.3											
	SML010BAT	SML011BBT	SML012BCT	SML011EBT	SML012ECT	SML-011YT	SML-012YT	SML-011DT	SML-012DT	SML-011UT	SML-012UT

Note) "*" will be taken out for emitting color B/E series.

Absolute Maximum Ratings (Ta=25°C)

Part No.	Emitting color	Power dissipation Pd (mW)	Forward current IF (mA)	Peak forward current * I _{FP} (mA)	Reverse voltage VR (V)	Operating temperature T _{opr} (°C)	Storage temperature T _{stg} (°C)
SML010BAT	Blue	94	20	70	5	-30 to +85	-40 to +100
SML011BBT		84		100			
SML012BCT		84		100			
SML011EBT	Green	84	20	100	5	-30 to +85	-40 to +100
SML012ECT							
SML-011YT	Yellow	84	20	100	5	-30 to +85	-40 to +100
SML-012YT							
SML-011DT	Orange	75	30	100	5	-40 to +100	-40 to +100
SML-012DT							
SML-011UT	Red	75	30	100	5	-40 to +100	-40 to +100
SML-012UT							

* I_{FP} measured under duty ≤1/10, 1kHz.

External Dimensions (Unit : mm)

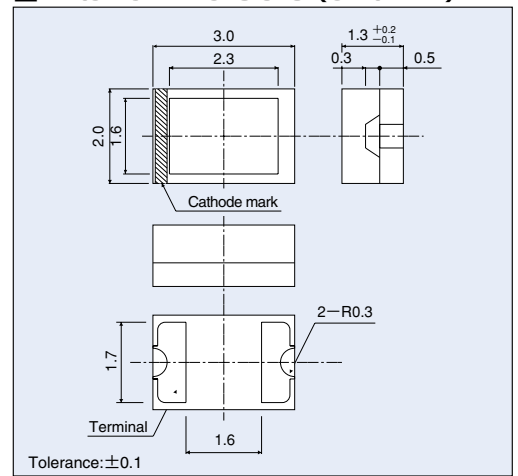

Electrical Optical Characteristics (Ta=25°C)

Part No.	Resin Color	Forward voltage VF		Reverse current IR		Light wavelength			Brightness Iv		
		Typ. (V)	IF (mA)	Max. (μA)	VR (V)	Peak λp (nm)	Half-wave Δλ (nm)	IF (mA)	Min.	Typ.	IF
									(mcd)	(mcd)	(mA)
SML010BAT	Transparent Clear	3.8	20	100	5	428	65	20	3.6	9	20
SML011BBT						22	36		22	36	
SML012BCT		3.5	20	100	5	468	26	36	100	36	100
SML011EBT						523	36	56	140	56	140
SML012ECT		3.8	20	100	5	518	35	140	360	140	360
SML-011YT						590	15	36	100	36	100
SML-012YT		2.0	10	100	5	611	17	22	63	22	63
SML-011DT						36	140	36	140		
SML-012DT		2.0	10	100	5	630	18	22	63	22	63
SML-011UT						36	100	36	100		
SML-012UT											

Directivity

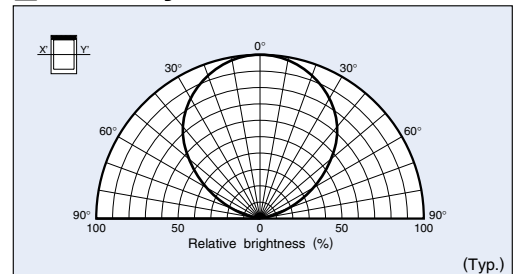

Recommended Pad Layout

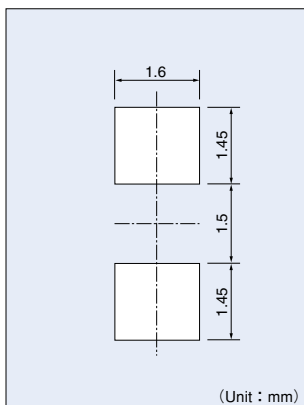

The recommended thickness of the screen mask for soldering is between 100 and 200 μm. The hole size of the screen mask should be same as the recommended land pattern or smaller.

Packaging Specifications (Unit : mm)

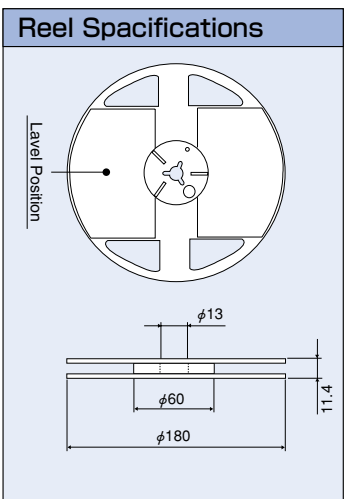
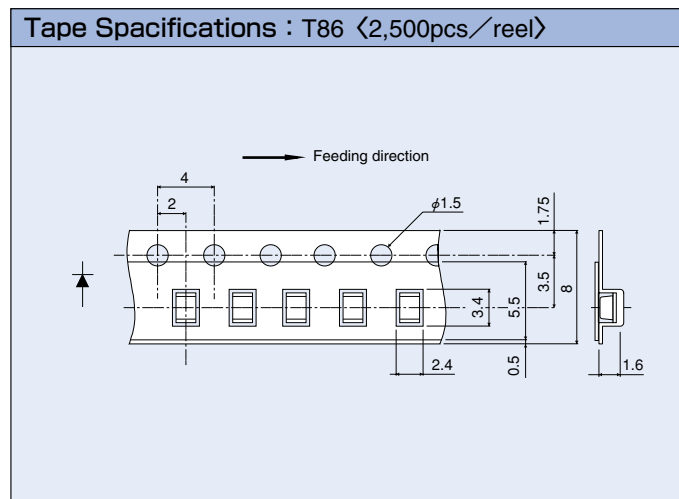

Electrical Characteristic Curves

Forward Current - Forward Voltage

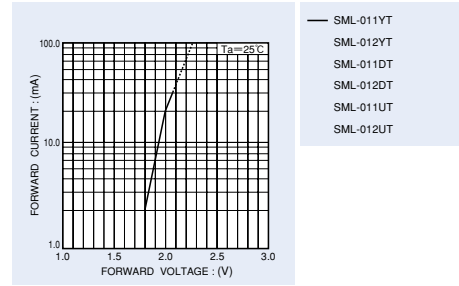
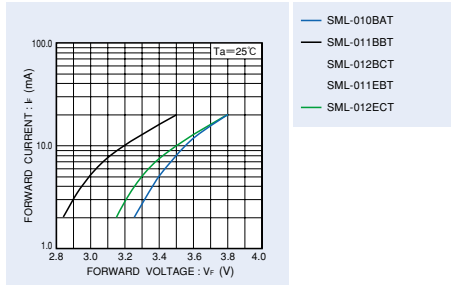

Relative Luminous Intensity - Case Temperature

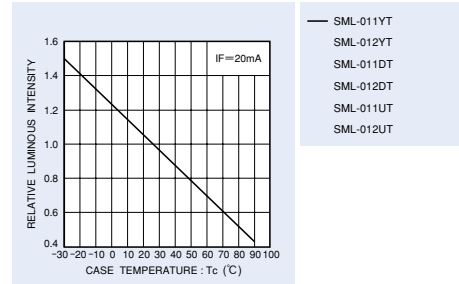
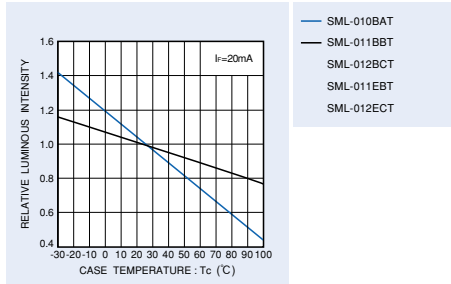

Relative Luminous Intensity - Forward Current

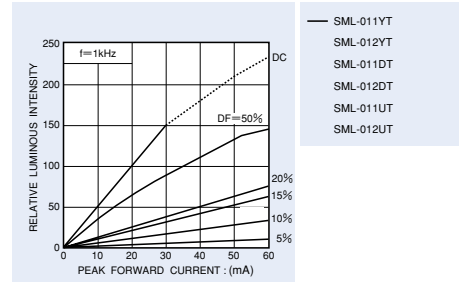
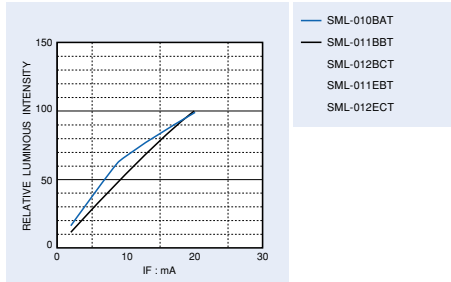

Ratio of Maximum Tolerable Peak Current - Pulse Duration

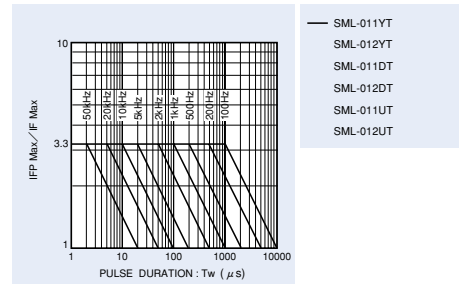
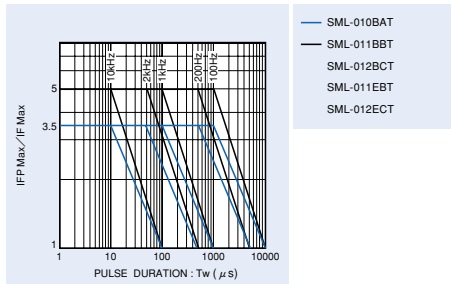

Derating

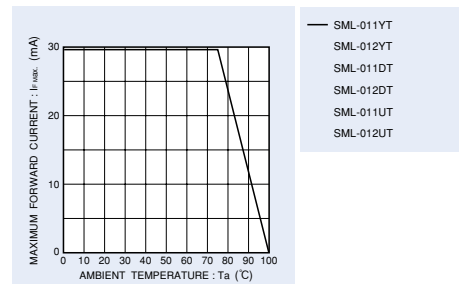
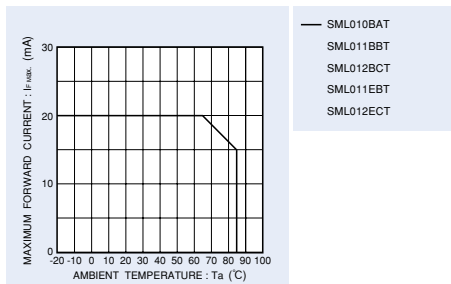

Notes

- No technical content pages of this document may be reproduced in any form or transmitted by any means without prior permission of ROHM CO.,LTD.
- The contents described herein are subject to change without notice. The specifications for the product described in this document are for reference only. Upon actual use, therefore, please request that specifications to be separately delivered.
- Application circuit diagrams and circuit constants contained herein are shown as examples of standard use and operation. Please pay careful attention to the peripheral conditions when designing circuits and deciding upon circuit constants in the set.
- Any data, including, but not limited to application circuit diagrams information, described herein are intended only as illustrations of such devices and not as the specifications for such devices. ROHM CO.,LTD. disclaims any warranty that any use of such devices shall be free from infringement of any third party's intellectual property rights or other proprietary rights, and further, assumes no liability of whatsoever nature in the event of any such infringement, or arising from or connected with or related to the use of such devices.
- Upon the sale of any such devices, other than for buyer's right to use such devices itself, resell or otherwise dispose of the same, no express or implied right or license to practice or commercially exploit any intellectual property rights or other proprietary rights owned or controlled by
- ROHM CO., LTD. is granted to any such buyer.
- Products listed in this document are no antiradiation design.

The products listed in this document are designed to be used with ordinary electronic equipment or devices (such as audio visual equipment, office-automation equipment, communications devices, electrical appliances and electronic toys).

Should you intend to use these products with equipment or devices which require an extremely high level of reliability and the malfunction of which would directly endanger human life (such as medical instruments, transportation equipment, aerospace machinery, nuclear-reactor controllers, fuel controllers and other safety devices), please be sure to consult with our sales representative in advance.

About Export Control Order in Japan

Products described herein are the objects of controlled goods in Annex 1 (Item 16) of Export Trade Control Order in Japan.

In case of export from Japan, please confirm if it applies to "objective" criteria or an "informed" (by MITI clause) on the basis of "catch all controls for Non-Proliferation of Weapons of Mass Destruction.